

SonTek, a Xylem brand
9940 Summers Ridge Road, San Diego, CA 92121-3091 USA
Telephone (858) 546-8327 • Fax (858) 546-8150
E-mail: inquiry@sontek.com • Internet: <http://www.sontek.com>



**RiverSurveyor S5/M9
System Manual
Software Version 4.2
Firmware Version 4.10**

Copyright 2022 by SonTek, a Xylem brand. All rights reserved. This document may not, in whole or in part, be copied, photocopied, reproduced, translated, or reduced to any electronic medium or machine-readable form without prior consent in writing from SonTek, a Xylem brand. Every effort has been made to ensure the accuracy of this manual. However, SonTek, a Xylem brand makes no warranties with respect to this documentation and disclaims any implied warranties of merchantability and fitness for a particular purpose. SonTek, a Xylem brand shall not be liable for any errors or for incidental or consequential damages in connection with the furnishing, performance, or use of this manual or the examples herein. The information in this document is subject to change without notice.

RECORD OF CHANGES

Effective	Description
15 FEB 2009	Initial release; CPU firmware version 1.0
15 FEB 2010	RiverSurveyor Live v1.50 support
01 OCT 2010	SmartPulseHD™ Release; FCC and CE Declarations
15 OCT 2010	RiverSurveyor Stationary Live v1.00 support
28 MAR 2011	Software Updates including Loop Method
26 SEP 2011	Software Updates including CastAway CTD and ASCII Export
16 JUL 2012	Firmware v3.00, RSL Software v3.50 and RSSL Software v2.50
02 FEB 2013	RSL Software v3.60 and RSSL Software v2.60
02 AUG 2013	Support for new (Second Generation) PCM.
09 JAN 2014	Added photos and documentation for the Bridge
01 OCT 2014	G3 compass, RSL, RSSL and Utilities software v3.80. Firmware v3.80
01 MAR 2015	Firmware v3.81 for tablet software v3.81
30 SEP 2015	RSL, RSSL and Utilities software v3.90. Firmware v3.91
06 MAY 2016	RSL, RSSL and Utilities software v3.9.50. Firmware v3.96
01 NOV 2016	RSL, RSSL and Utilities software v4.0. Firmware v4.02
01 MAY 2018	RSL, RSSL and Utilities software v4.1. Firmware v4.02
01 MAY 2022	RSL, RSSL and Utilities software v4.2. Firmware v4.10

IMPORTANT SAFETY NOTICE

If the system is not used or stored for long periods, remove the batteries to prevent unnecessary draining and potential battery leakage.



It's good practice to remove the battery cartridge at the end of each workday for inspection and charging/replacement.

Warning About Batteries:

As with any modern electronic equipment, especially those utilizing powerful radio transmission, the RiverSurveyor system and associated Power & Communications Module (PCM) can draw significant electrical current and therefore generate substantial heat.

SonTek has designed certain safety measures into the system to prevent it from overheating. However, in order to prevent overheating, make sure to **DISCONNECT THE RIVERSURVEYOR M9/S5 FROM THE PCM WHENEVER STORING THE SYSTEM OR DURING LONG PERIODS OF INACTIVITY (SEVERAL HOURS), ESPECIALLY WHEN NOT CONNECTED TO THE GPS (IF APPLICABLE) OR OUTSIDE OF GPS COVERAGE.** Disconnecting the M9/S5 from the PCM will cause the PCM to go into a safe, low-power state with minimal battery drain. In this low-power state, battery life will typically last 7-10 days. Low-power state is activated 10-minutes after the M9/S5 is disconnected from the PCM.

For storage periods greater than 1-2 weeks, SonTek recommends not only **DISCONNECTING THE M9/S5 FROM THE PCM BUT ALSO REMOVING ALL BATTERIES.**

Warning About Radio Transmission:

To satisfy FCC RF exposure requirements for mobile transmitting devices, a separation distance of 20 cm or more should be maintained between the antenna of this device and persons during operation. To ensure compliance, operations at closer distances than this are not recommended. This is applicable to all radios that are part of the RiverSurveyor system: **Bridge, PCMs and USB Radio** dongle.

DECLARATION OF CONFORMITY

The undersigned hereby declares that the product listed below conforms to all applicable requirements of the **U.S. Federal Communications Commission (FCC)** and **Industry Canada (IC)**.

Manufacturer: SonTek – a Xylem brand
9940 Summers Ridge Road
San Diego, CA 92121 USA

Declares that the Product

Product name: RiverSurveyor
Model numbers: M9

Accessories: (1) SonTek PCM Rover & Base

Intentional Radiators: (PCM) FCC ID: S4GEM35XB

Test Report Numbers: 448164-1TRFEMC

Conforms to the following standards and regulations

EMC: FCC 47 CFR Part 15, Subpart B
IC ICES-003 Issue 7: 2020

This device complies with Part 15 of the FCC rules. Operation is subject to the following two conditions:

1. This device may not cause harmful interference, and
2. This device must accept any interference received, including interference that may cause undesired operation.



E.J. Rollo, Compliance Engineer
March 31, 2022

DECLARATION OF CONFORMITY

The undersigned hereby declares that the product listed below conforms to all applicable Essential Requirements of the listed Directives and Standards and carry the **CE** mark.

Manufacturer: SonTek – a Xylem brand
9940 Summers Ridge Road
San Diego, CA 92121 USA

Declares that the Product

Product name: RiverSurveyor
Model numbers: M9

Accessories: (1) SonTek PCM Rover & Base

Intentional Radiators: (PCM) FCC ID: S4GEM35XB

Test Report Numbers: 448164-6TRFEMC, 448164-4TRFEMC, 448164, 153094

Conforms to the following standards and regulations

EMC: 2014/30/EU, EN 61326-1: 2013 (Electrical equipment for measurement, control and laboratory use)
2014/53/EU, ETSI EN 301 489-1, -17, -19 (Standard for radio equipment and services)

Safety: RED 2014/53/EU, IEC 61010-1:2010, AMD1:2016 (Safety requirements for electrical equipment for measurement, control, and laboratory use)

RoHS: 2011/65/EU (includes RoHS-3 amendment 2015/863/EU)

WEEE: 2012/19/EU

REACH: 1907/2006



E.J. Rollo, Compliance Engineer
March 31, 2022

DECLARATION OF CONFORMITY

The undersigned hereby declares that the product listed below conforms to all applicable Essential Requirements of the listed Directives and Standards and carry the **UKCA** mark.

Manufacturer: SonTek – a Xylem brand
9940 Summers Ridge Road
San Diego, CA 92121 USA

Declares that the Product

Product name: RiverSurveyor
Model numbers: M9

Accessories: (1) SonTek PCM Rover & Base

Intentional Radiators: (PCM) FCC ID: S4GEM35XB

Test Report Numbers: 448164-6TRFEMC, 448164-4TRFEMC, 448164, 153094

Conforms to the following standards and regulations

EMC: 2014/30/EU, EN 61326-1: 2013 (Electrical equipment for measurement, control and laboratory use)
2014/53/EU, ETSI EN 301 489-1, -17, -19 (Standard for radio equipment and services)

Safety: RED 2014/53/EU, IEC 61010-1:2010, AMD1:2016 (Safety requirements for electrical equipment for measurement, control, and laboratory use)

RoHS: 2011/65/EU (includes RoHS-3 amendment 2015/863/EU)

WEEE: 2012/19/EU

REACH: 1907/2006



E.J. Rollo, Compliance Engineer
March 31, 2022

DECLARATION OF CONFORMITY

The undersigned hereby declares that the product listed below conforms to all applicable requirements of the **Australian and New Zealand Communications and Media Authority** standards.

Manufacturer: SonTek – a Xylem brand
9940 Summers Ridge Road
San Diego, CA 92121 USA

Declares that the Product

Product name: RiverSurveyor
Model numbers: M9

Accessories: **(1)** SonTek PCM Rover & Base

Intentional Radiators: **(PCM)** FCC ID: S4GEM35XB

Test Report Numbers: 448164-1TRFEMC

Conforms to the following standards and regulations

EMC: AS/NZS CISPR 11: 2011 (Electromagnetic compatibility (EMC) standard for radiated disturbance)



E.J. Rollo, Compliance Engineer
March 31, 2022

DECLARATION OF CONFORMITY

The undersigned hereby declares that the product listed below conforms to all applicable requirements of the **Radio Wave Act of Korea**.

Manufacturer: SonTek – a Xylem brand
9940 Summers Ridge Road
San Diego, CA 92121 USA

Declares that the Product

Product name: RiverSurveyor
Model numbers: M9

Accessories: (1) SonTek PCM Rover & Base

Intentional Radiators: (PCM) FCC ID: S4GEM35XB

Test Report Numbers: 448164-5TRFEMC

Conforms to the following standards and regulations

EMC: KS C 9832: 2019
KS C 9835: 2019
KS X 3124: 2020
KS X 3126: 2020



E.J. Rollo, Compliance Engineer
March 31, 2022

DECLARATION OF CONFORMITY

The undersigned hereby declares that the product listed below conforms to all applicable requirements of the **Japanese Information and Communications Council under Ministry of Internal Affairs and Communications**.

Manufacturer: SonTek – a Xylem brand
9940 Summers Ridge Road
San Diego, CA 92121 USA

Declares that the Product

Product name: RiverSurveyor
Model numbers: M9

Accessories: (1) SonTek PCM Rover & Base

Intentional Radiators: (PCM) FCC ID: S4GEM35XB

Test Report Numbers: 448164-2TRFEMC

Conforms to the following standards and regulations

EMC: VCCI 32-1 (CISPR 32), VCCI-CISPR 32:2016 (Agreement of Voluntary Control Council for Interference by Information Technology Equipment)



E.J. Rollo, Compliance Engineer
March 31, 2022

DECLARATION OF CONFORMITY

The undersigned hereby declares that the product listed below conforms to all applicable requirements of the **Chinese National Standard (CNS), the National Standards of the Republic of China (Taiwan)**.

Manufacturer: SonTek – a Xylem brand
9940 Summers Ridge Road
San Diego, CA 92121 USA

Declares that the Product

Product name: RiverSurveyor
Model numbers: M9

Accessories: (1) SonTek PCM Rover & Base

Intentional Radiators: (PCM) FCC ID: S4GEM35XB

Test Report Numbers: 448164-3TRFEMC

Conforms to the following standards and regulations

EMC: CNS 13438: 2006 Class A

RoHS: China RoHS II



E.J. Rollo, Compliance Engineer
March 31, 2022

Release Notice

This is the May 2022 release of the *RiverSurveyor S5/M9 System Manual*. During the creation of this manual, the following were the latest versions of firmware/software. As such, if you are using different firmware/software versions, not all aspects of this manual may apply.

- RiverSurveyor S5/M9 firmware version 4.10
- *RiverSurveyor Live* software version 4.2
- *RiverSurveyor Stationary Live* software version 4.2

Trademarks

The terms SonTek, ADP, ADV, Argonaut, FlowTracker, and RiverSurveyor are registered trademarks of YSI Inc. All rights are reserved. All other brand names are trademarks of their respective holders.

Warranty Terms and Conditions

The system you have purchased is covered under a two year limited warranty that extends to all parts and labor for any malfunction due to workmanship or errors in the manufacturing process. The warranty is conditioned upon your proper maintenance and operation under normal use as outlined in the User's Manual that was provided along with the system. The warranty does not cover shortcomings that are due to the design, nor does it cover any form of incidental damage as a result of errors in the measurements.

SonTek, a Xylem brand will repair and/or replace, at its sole option, any product established to be defective, with a product of like type. CLAIMS FOR LABOR COSTS AND/OR OTHER CHARGES RESULTING FROM THE USE OF SonTek, a Xylem brand GOODS AND/OR PRODUCTS ARE NOT COVERED BY THIS LIMITED WARRANTY.

SonTek, a Xylem brand DISCLAIMS ALL EXPRESS WARRANTIES OTHER THAN THOSE CONTAINED ABOVE AND ALL IMPLIED WARRANTIES, INCLUDING BUT NOT LIMITED TO WARRANTIES OF MERCHANTABILITY AND/OR FITNESS FOR A PARTICULAR PURPOSE. It is understood and agreed that SonTek DISCLAIMS AND WILL NOT BE LIABLE, UNDER ANY CIRCUMSTANCE, IN CONTRACT, TORT OR WARRANTY, FOR ANY SPECIAL, INDIRECT, INCIDENTAL OR CONSEQUENTIAL DAMAGES OF ANY KIND, INCLUDING BUT NOT LIMITED TO LOST PROFITS, BUSINESS INTERRUPTION LOSSES, LOSS OF GOODWILL, OR LOSS OF BUSINESS OR CUSTOMER RELATIONSHIPS. Some states do not allow the exclusion of implied warranties or the limitation or exclusion of liability for incidental or consequential damages, so the above exclusion may not apply to the Buyer. The parties specifically agree that the scope and enforceability of this provision shall be governed by California law.

If your system is not functioning properly, first try to identify the source of the problem. If additional support is required, we encourage you to contact us immediately. We will work to resolve the problem as quickly as possible.

If the system needs to be returned to the factory, please contact SonTek, a Xylem brand, to obtain a Service Request (SR) number. We reserve the right to refuse receipt of shipments without SRs. We require the system to be shipped back in the original shipping container using the original packing material with all delivery costs covered by the customer (including all taxes and duties). If the system is returned without appropriate packing, the customer will be required to cover the cost of a new packaging crate and material.

This device complies with part 15 of the FCC Rules. Operation is subject to the following two conditions: (1) This device may not cause harmful interference, and (2) this device must accept any interference received, including interference that may cause undesired operation.

About This Manual

Thank you for your interest in using a SonTek RiverSurveyor S5 or M9 system. This *RiverSurveyor S5/M9 System Manual* describes how to install and configure the RiverSurveyor system and its associated software. It includes instructions and guidelines for the most common applications for which this system is used.

Scope and Audience

Even if you have used other SonTek acoustic Doppler products, we recommend that you spend some time reading this manual to learn about the special features of this system.

This manual is more “application-oriented” in that it tries to explain how to use the RiverSurveyor system for specific, real-world applications. If you intend to use the instrument for other applications, or if you need detailed information about the instrument itself, please [contact us](#).

How to Use This Manual

This manual was especially designed for on-line viewing through a computer. Even though you may now be reading a paper copy of this manual, an “electronic” copy of this manual was provided to you on the distribution disk (*RiverSurveyor.pdf*).

The use of this “PDF” file requires you to have the **Adobe® Acrobat Reader®** software installed on your computer. This software is freely available from Adobe at <http://www.adobe.com>.

This *RiverSurveyor.pdf* file is also used as a Help file within the *RiverSurveyor Live* software program. If you install *RiverSurveyor Live* on your computer using the default installation instructions, the *RiverSurveyor.pdf* file will be in the folder C:\Program Files\SonTek\Manuals.

The PDF version of this manual makes it easy for you to navigate within the document. Several hyperlinks (in blue) let you quickly go to referenced sections, figures, and tables. Additionally, you can use the built-in search features of Acrobat to find specific words and phrases. With the PDF copy, you can also print out high-quality copies of the manual to paper (for your organization’s personal use only and not for resale or redistribution).

Reader Feedback

Your feedback about the RiverSurveyor system and this manual will help us to improve our products. Please let us know what improvements we can make by contacting us via telephone, fax, or e-mail (see next page for [Contact Information](#)).

Contact Information

Any questions, concerns, or suggestions can be directed to SonTek by telephone, fax, or email. Business hours are 8:00 a.m. to 5:00 p.m., Pacific Standard Time, Monday through Friday.

Phone : +1 (858) 546-8327

Fax : +1 (858) 546-8150

Email : inquiry@sontek.com (General information)

sales@sontek.com (Sales information)

support@sontek.com (Support information)

Web : <http://www.sontek.com>

See our web site for information concerning new products and software/firmware upgrades.

Table of Contents

IMPORTANT SAFETY NOTICE	iii
About This Manual	xii
Table of Contents	xiv
Section 1. Getting Started	1
1.1. What does the System do?.....	1
1.2. What's new?	1
Section 2. RiverSurveyor Instrument Configuration and Options	3
2.1. RiverSurveyor Core System S5 and M9.....	3
2.2. Power and Communications Module (PCM) – Optional	5
2.2.1. Bluetooth Option.....	6
2.2.2. Spread Spectrum (SS) Option.....	6
2.3. GPS Components – Optional	6
2.3.1. SonTek RTK GPS - Optional.....	7
2.3.2. SonTek DGPS - Optional	8
2.4. SonTek Hydroboard and HydroBoard II - Optional.....	8
2.5. OceanScience Riverboat – Optional.....	8
Section 3. System Configurations and Setup	9
3.1. Overview.....	9
3.2. Configuration A – Direct Connection with S5 or M9 Core System.....	9
3.2.1. Description	9
3.2.2. Hardware Setup	9
3.3. Configuration B – Bluetooth Communications	10
3.3.1. Description	10
3.3.2. Hardware Setup	11
3.4. Configuration C – Spread Spectrum Communications	12
3.4.1. Description	12
3.4.2. Hardware Setup	13
3.5. Configuration D – RTK GPS	14
3.5.1. Description	14
3.5.2. Hardware Setup	16
3.6. Configuration E – SonTek Differential GPS.....	18
3.6.1. Description	18
3.6.2. Hardware Setup	18
3.7. Configuration F - SonTek HydroBoard	19
3.7.1. Description	19
3.7.2. Hardware Setup	19
Section 4. System Maintenance	21
4.1. Overview.....	21
4.2. Cleaning the transducers.....	21
4.3. Cables and connectors	21
4.4. O-rings.....	21
4.5. Batteries.....	21
4.6. Tablet.....	22
4.7. Mobile Device	22

4.8. Factory Calibration.....	22
Section 5. Introduction to Measurement Procedure	23
5.1. Overview.....	23
5.2. Applications	23
5.3. Pre-Measurement Tests	23
5.3.1. Check cables and connections.....	23
5.3.2. Communications.....	23
5.3.3. System Test	24
5.3.4. Compass Calibration	24
5.3.5. Recorder.....	25
5.3.6. Measurement Procedure.....	25
5.3.7. Overview	25
5.3.8. Starting the System	27
5.3.9. Collecting Start Edge Data	27
5.3.10. Collecting Transect Data	27
5.3.11. Collecting End Edge Data	28
5.3.12. Making Additional Measurements/Transects	28
Section 6. RiverSurveyor Live for PC & Tablet Software.....	29
6.1. Overview – RiverSurveyor Live for PC Software	29
6.2. PC System Requirements	29
6.3. Tablet System Requirements	29
6.4. PC Software Installation	29
6.5. Tablet Software Installation	31
6.6. Starting the Software	32
6.7. Connecting to the System.....	32
6.8. Site Information.....	34
6.9. System Settings.....	35
6.10. Edge Settings	38
6.11. Pre-Measurement Tests and Utilities.....	39
6.11.1. G3 Compass Calibration	39
6.11.2. Compass Calibration Feedback	43
6.11.3. Compass Quality During Measurement	43
6.11.4. System Test	44
6.11.5. Set Time	45
6.11.6. BeamCheck.....	45
6.11.7. Update Firmware.....	46
6.11.8. SonTek GPS Option.....	46
6.11.9. Loop Method	47
6.11.10. SMBA Method	47
6.11.11. Manual Configuration	48
6.12. Recorder	50
6.13. Data Collection	50
6.13.1. Start System.....	51
6.13.2. Start Edge	52
6.13.3. Start Moving	54
6.13.4. End Edge.....	54
6.13.5. End Transect.....	56
6.13.6. Real-Time Quality Control	56
6.14. Discharge Measurement Summary	61
6.15. Saving a measurement – SonTek File Compression Utility.....	62

Section 7. RiverSurveyor Live for Mobile	65
7.1. Overview—RiverSurveyor Live for Mobile Software.....	65
7.2. Mobile Device Requirements.....	65
7.3. Installation.....	65
7.4. Navigation and Controls for Mobile Device.....	68
7.5. Starting the Software and Connecting to the System.....	68
7.6. Preparing for a Measurement - Main Menu.....	69
7.6.1. Site Information (1).....	70
7.6.2. System Settings (2).....	70
7.6.3. Track and Depth Reference (3).....	72
7.6.4. Compass Calibration (4).....	74
7.6.5. Download Recorder (5).....	75
7.6.6. Measurement Summary (6).....	76
7.6.7. Utilities (7).....	77
7.7. Discharge Measurement - Data Collection.....	81
7.7.1. Starting the measurement.....	81
7.7.2. Start Edge.....	82
7.7.3. Start Moving.....	83
7.7.4. End Edge.....	85
7.7.5. End Transect.....	86
7.7.6. Data collection - Swapping between Mobile Device and PC.....	87
7.7.7. Transferring Data from Mobile Device to PC.....	87
Section 8. Reviewing Data Files/Post-Processing	89
8.1. Overview.....	89
8.2. Opening Data Files.....	89
8.3. Application Layout.....	90
8.3.1. Main Toolbar Icons.....	90
8.3.2. Data file Tabs.....	91
8.3.3. Sidebar.....	91
8.3.4. Tab Windows Selection.....	93
8.3.5. Tab Window Display.....	93
8.3.6. Discharge measurement summary.....	97
8.3.7. Processing toolbox.....	98
8.3.8. SonTek File Manager.....	102
8.3.9. Compress Measurement Files.....	102
8.3.10. Load GIS Shape File.....	104
8.4. Hot Keys/Accelerators.....	104
8.5. Processing Data Files – Step by Step.....	105
Appendix A. Description of RiverSurveyor Live Icons	107
Appendix B. Parameter and Hotkey Descriptions	111
Appendix C. MATLAB Export	113
Appendix D. Troubleshooting	120
Appendix E. Software Changes	129
Appendix F. SmartPulse^{HD™} Principles	145
Appendix G. Stationary Measurement Software	147

G-1. Overview.....	147
G-2. System Requirements	147
G-3. Installation.....	147
G-4. Making a Measurement	149
G-5. Selecting a Measurement Location	152
G-6. M9/S5 Mounting and Instrument Orientation	152
G-7. Software Operation – Without GPS	154
G-8. Software Operation – WITH GPS	175
G-9. Discharge Measurement Report.....	200
Appendix H. Loop Method.....	203
Appendix I. CastAway CTD Integration	212
Appendix J. Power and Communications Module II (PCM2)	216
J-1. What's new?	216
J-2. SonTek Communications Bridge	217
J-3. SonTek (USB) Radio	219
J-4. Configuration A – PCM (Telemetry Only)	221
J-5. Configuration B – Differential GPS (DGPS).....	222
J-6. Configuration C – Real-Time Kinematic GPS (RTK-GPS)	224
J-7. Optional Tablet	228
J-8. LED Description.....	229
Appendix K. Compass Calibration for G0-G2 Compasses.....	231

Section 1. Getting Started

1.1. What does the System do?

The SonTek RiverSurveyor system is a robust and highly accurate Acoustic Doppler Profiler (ADP) system specifically designed to measure river discharge, 3-Dimensional water currents, depths, and bathymetry from a moving or stationary vessel. The RiverSurveyor system combines proven state-of-the-art acoustic Doppler velocity profiler instrumentation with a Windows-based software package that can be used on a Personal Computer (PC) or Mobile device. The high degree of accuracy and ease of use allows you to measure confidently without having to change measurement settings for a specific river condition.

First-time users will find data collection and analysis a relatively simple task, while advanced users will benefit from the flexible processing and analytical tools that are provided. One of the major benefits of the RiverSurveyor system is that it is easy to program – time-consuming and complicated training courses are not required before you can start collecting meaningful data.

1.2. What's new?

Shallow and/or deep water profiling solutions – The ADP can be either one of the following types. Both of these profilers are described in detail in Section 2.

- **S5 ADP:** A five-beam system with four profiling beams and one vertical beam. The S5 has a velocity measurement range of up to 5 m and a discharge measurement range of 15 m (when referencing GPS and the vertical beam).
- **M9 ADP:** A nine-beam system with two sets of four profiling beams (each set having its own frequency) and one vertical beam. The M9 has a velocity profiling range of up to 40 m and a discharge measurement range of 80 m (when referencing GPS and the vertical beam).

Multi-frequency – Multiple acoustic frequencies fused with precise bandwidth control make for the most robust and continuous shallow-to-deep measurements ever for an ADP. A deterministic microcontroller automatically apportions the appropriate acoustics and pulse schemes as you cross the river. This allows you to focus on the measurement technique, and not on the instrument setup. The result of the automatic adjustments is that it gives you the best measurement settings possible at all times, no matter the depth and velocity of the river.

Automated cell size adjustments – As you go from shallow to deep water, the cell size automatically adjusts to optimize performance and resolution. This feature further enhances your ability to measure continuously in dynamic river conditions.

Vertical beam – A low-frequency, fast-sampling vertical beam extends the maximum depth range of the system and provides superior channel definition for river discharge measurements and bathymetric surveys. The vertical beam also provides you the confidence that you will measure the proper depth during extreme conditions such as high-sediment flows and floods.

Integrated GPS, Power, and Communications – The RiverSurveyor Power and Communications Module (PCM) brings unmatched ease of use and flexibility to the S5 and M9 ADPs. The PCM contains an optional rechargeable battery pack for power, factory-configured, 2.4 GHz radio, Bluetooth® radio or Spread Spectrum (SS) radio (for communication with a PC or a compatible Mobile device; see §6.2), and an optional GPS enclosed in a water-tight housing.

RTK GPS integration – Available exclusively from SonTek, the RTK (real-time kinematic) GPS optional solution is easy to use and offers incredibly precise positioning and fast data sampling rates (10-Hz). This option can augment or be an alternative to Bottom-Track and positioning. Unlike existing “Differential” GPS solutions, which sometimes requires 50+ meters width for a

reliable discharge measurement, RTK GPS allows you to measure minimum stream widths consistently to less than 1 meter.

Internal Discharge Calculations – All calculations are performed inside the ADP. This gives you the increased flexibility to collect data, disconnect from the system, and then reconnect to the system during data collection without stopping the data collection process and without the fear of losing data. It avoids any possibility of data loss if communication is lost or becomes intermittent. You can even change communications devices (to/from PC or Mobile device) during a discharge measurement if needed.

Quality and status feedback – New, dynamic software interface and vibrant graphics for clear feedback in the office or field.

Review and analyze data faster – Load, view, and analyze multiple data sets simultaneously all from your PC.

Flexible Mobile Device operation – RiverSurveyor runs on both PC and Mobile device hosts giving you the flexibility to collect data to best suit your field requirements. Both software hosts also offer you the ability to make complete measurements without relying on secondary programs or utilities to extract or playback data.

SmartPulse^{HD™} - SmartPulse^{HD} is an intelligent algorithm that looks at water depth, velocity, and turbulence, and then adapts the acoustic pulse scheme to those conditions. It uses multi-band acoustics, pulse-coherent, broadband, and incoherent techniques to provide the highest resolution velocity data possible. And, just like an HD-TV, it lets you see the clearest velocity picture possible with cell sizes down to 2 cm.

Patent # 8,125,849 on Multi-frequency, Automated cell size adjustments, Vertical beam, SmartPulse^{HD™} and Internal Discharge Calculations

Section 2. RiverSurveyor Instrument Configuration and Options

IMPORTANT NOTE: This section describes only the First Generation Power and Communications Modules (PCM). For information on SonTek's Second Generation PCM, please see **Appendix J**.

The RiverSurveyor discharge measurement system is flexible enough to fit most every field setup requirement you will need. The core system includes everything you need to make a direct-connect discharge measurement from a manned powerboat and external power supply. The options are modular, designed to be used with any S5 or M9 system, to best suit your field measurement needs. The following is a brief description of the core system and the options available with the new RiverSurveyor discharge measurement system.

2.1. RiverSurveyor Core System S5 and M9

The core system includes:

Part Description	Qty
Multi Frequency ADP (S5 or M9)	1
User Software Disc	1
ADP QuickStart Guide	1
Power/Comm Cable (Std. 10m)	1
Power Supply (18V)	1
AC Power Cord	1

The S5 and M9 ADPs integrate a compass/2-axis tilt sensor, temperature sensor, 16-GB internal recorder, and a vertical acoustic beam (echo-sounder) for depth measurement.

- **S5** (Figure 1): This portable, 5-beam ADP with a velocity profiling range of 0.2 to 5.0 m is ideal for use in shallow channels. The S5 has a 5-inch (13-cm) diameter Delrin housing that narrows to 3.2 inches (8.1-cm). It has four 3.0-MHz velocity measurement transducers in a Janus configuration. A 1.0-MHz vertical acoustic beam (echo sounder) provides depth data.

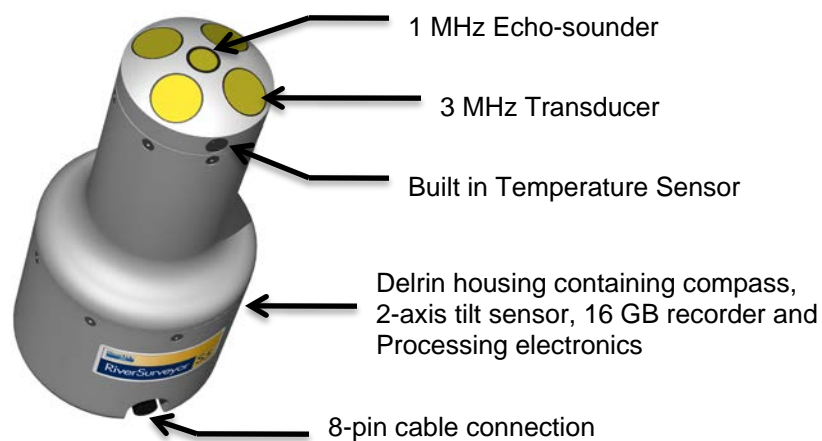

Figure 1. S5 ADP Features

- **M9** (Figure 2): This portable, 9-beam ADP with a velocity profiling range of 0.2 to 30 m is intended for use from moving or stationary boats/floating devices in both shallow and deep channels. The M9 has a 5-inch (13-cm) diameter Delrin housing. It has two sets of velocity measurement transducers, both in a Janus configuration – four 3.0-MHz transducers and four 1.0-MHz transducers. A 0.5-MHz vertical acoustic beam (echo sounder) provides depth data.

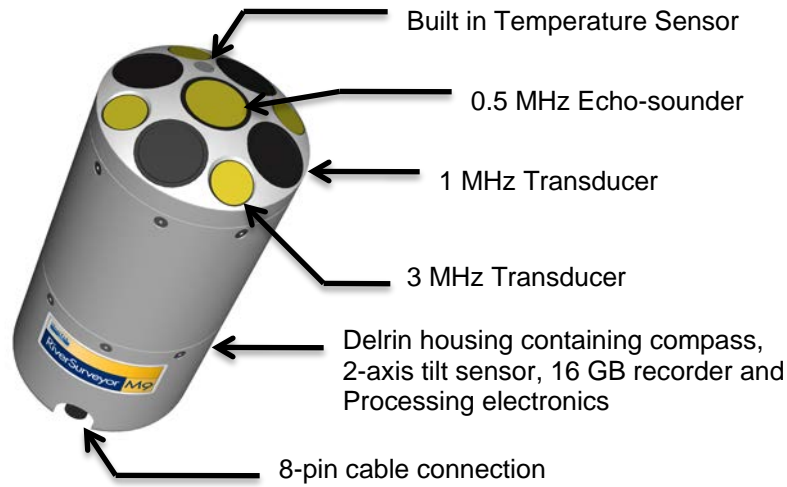

Figure 2. M9 ADP Features

The four brass inserts on top of the ADP can be used to secure the ADP to a mount on the side of a boat or to mount the optional GPS antenna. Figure 3 shows a dimensioned drawing of the brass insert locations in inches and millimeters.

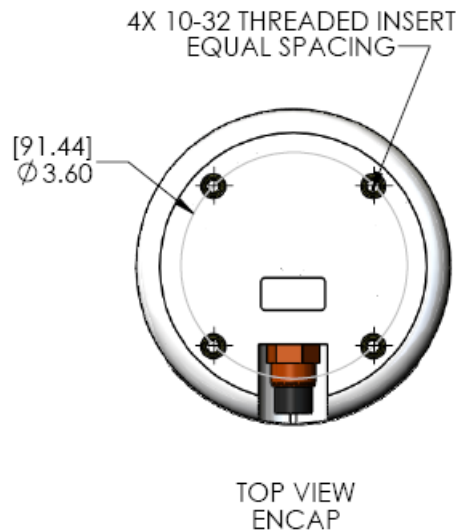

Figure 3. Brass Insert Locations

2.2. Power and Communications Module (PCM) – Optional

IMPORTANT NOTE: This section describes only the First Generation Power and Communications Modules (PCM). For information on SonTek's Second Generation PCM, please see **Appendix J**.

The PCM (Figure 4) connects directly to the S5 or M9 using a 1-m or 10-m cable. It provides power to the ADP using a rechargeable battery pack. It allows for remote communications with a PC or Mobile device via a radio link. There are two different radio communications options depending on range.

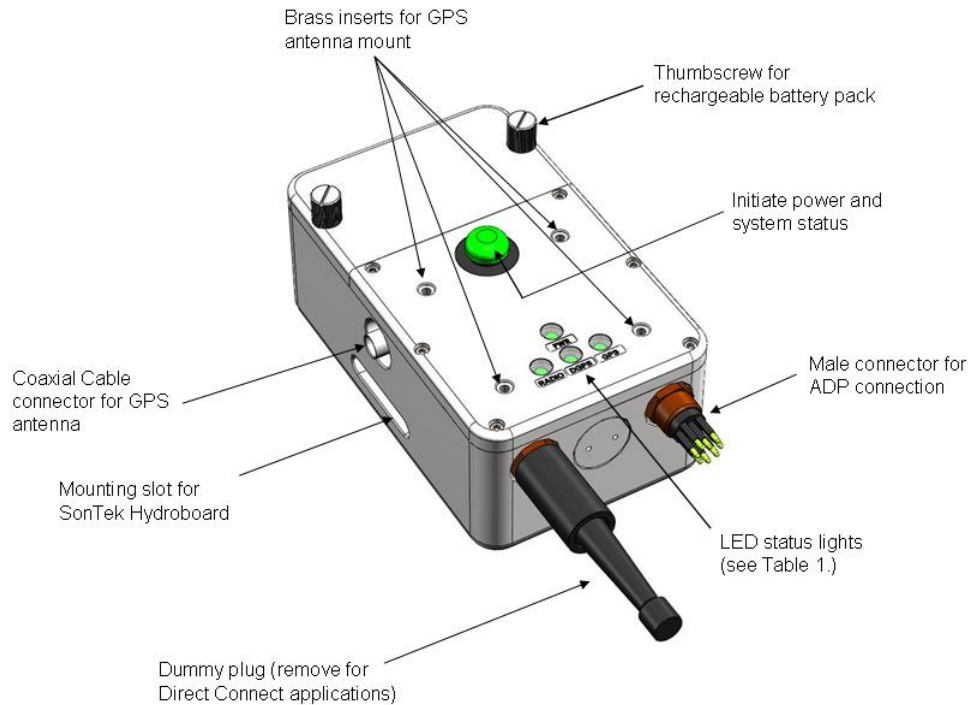

Figure 4. Power and Communications Module (PCM)

The PCM has four LEDs. Table 1 describes their purpose. In all cases, a green light would indicate that the component is functioning while a red/orange light would indicate that the system is not functioning. Below is a description for the LED labels.

Table 1. PCM LED Descriptions

Label	Description
PWR	Power
Radio	Radio Communication
DGPS*	Differential Quality GPS (Green)
GPS*	GPS Lock (Green)

*Note: Depends on optional GPS selection

Important: The dummy plug must be installed when using the PCM.

2.2.1. **Bluetooth Option**

A PCM with the Bluetooth option provides remote communication between the ADP and PC, Tablet or Mobile device. The maximum range using the supplied Bluetooth dongle plugged into a PC is up to 200m. The Bluetooth range of the Mobile device is approximately 60m. Those approximate ranges assume a clear line-of-sight with no obstructions or poor weather.

2.2.2. **Spread Spectrum (SS) Option**

A PCM with the Spread Spectrum radio option provides remote communication between the PCM and the SS Base radio connected to a PC. The operational range is about 2 km.

2.3. **GPS Components – Optional**

IMPORTANT NOTE: This section describes only the First Generation Power and Communications Modules (PCM). For information on SonTek's Second Generation PCM, please see **Appendix J**.

SonTek offers two GPS options integrated into the PCM. The first option provides RTK quality data (± 3 cm). RTK quality data requires additional hardware in the PCM as well as a separate RTK Base Station (Figure 5). The Base Station provides RTK corrections to the GPS receiver built into the PCM. The Differential GPS (DGPS) option does not require a Base Station, but additional hardware is required for the PCM. Some general rules of thumb for connection times for the various communications are:

- **GPS Lock:** Typically takes 5 minutes to turn from Red to Green (>1-m accuracy).
- **Differential Lock:** Typically takes up to about 5 minutes to turn from Red to flashing Red/Green (sub-meter accuracy).
- **RTK Lock:** Typically takes up to about 10 minutes to turn from alternatively flashing Red/Green to Green (± 3 cm accuracy).
- **BT/SS LED:** Turns to Green as soon as connection is established between PC/Phone and the system (assuming you are within range).
- **Base Station Radio Link Established:** Red light



Figure 5. Real-Time Kinematic (RTK) Base Station

2.3.1. SonTek RTK GPS - Optional

The RTK GPS option provides precise (± 3 cm) real-time kinematic position data to the ADP. The Bluetooth or Spread Spectrum PCM includes an internal RTK GPS receiver, an external, high-gain GPS antenna and a mounting mast. It also includes an additional Spread Spectrum radio modem for communication with the RTK Base Station. The RTK Base Station consists of an RTK GPS receiver with an external, high-gain GPS antenna, a Spread Spectrum radio modem for communication with the PCM, an external, high gain antenna and a mounting tripod. The Base Station receives GPS data at 10-Hz and provides RTK corrections at 1-Hz to the PCM connected to the ADP. The Base Station should be in a fixed location on shore. A direct line of sight is best for communication. The maximum communication range is about 2 km. Figure 6 shows the details for the Base Station.

Table 2 describes the Base Station LED labels.

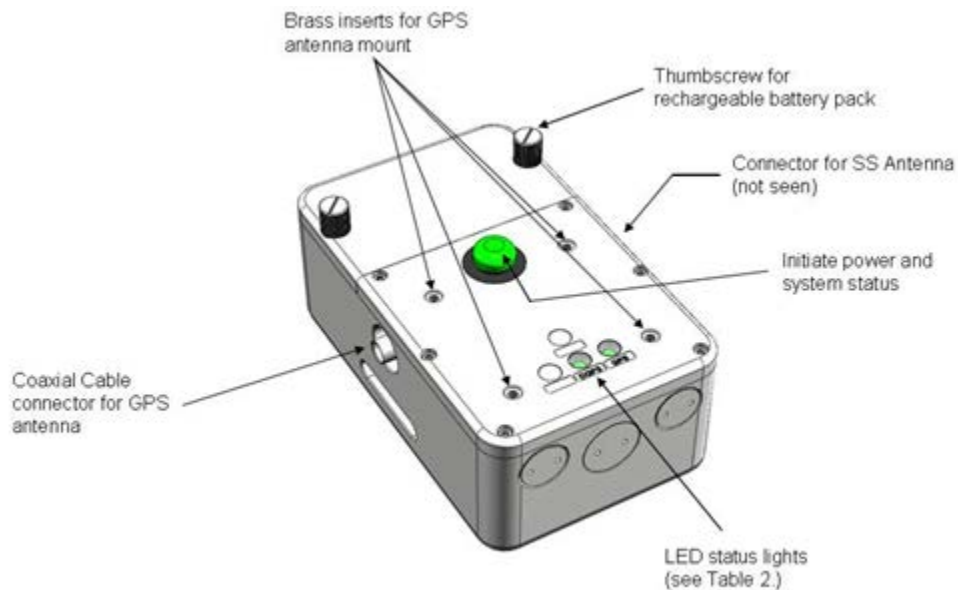

Figure 6. RTK Base Station Components

Table 2. RTK Base Station LED label descriptions

Label	Description
RTK	RTK Quality Connection (Green)
GPS	GPS Lock (Green)

The RTK Base Station receives GPS data via satellite and applies an RTK correction that is transmitted to the internal GPS of the PCM via Spread Spectrum radio communications. The RTK correction data is transferred to the ADP's internal memory for processing. It is then transmitted along with the ADP data from the PCM to the PC or Mobile device.

Note: If communication between the RTK Base Station and PCM is lost, a sub-meter correction is typically valid for up to 45 minutes without having to re-establish communications.

2.3.2. **SonTek DGPS - Optional**

The DGPS option provides sub meter differential GPS positioning data to the ADP. The Bluetooth or Spread Spectrum PCM includes a DGPS receiver and external antenna. No Base Station is required for this option.

The GPS satellites communicate with the differential GPS receiver inside the PCM. The DGPS data is received by the PCM at 10-Hz and transferred to the ADP's internal memory for integration and processing. It is then transmitted along with the ADP data from the PCM to the PC or Mobile device.

2.4. **SonTek Hydroboard and HydroBoard II - Optional**

The SonTek HydroBoard II (Figure 7) is specifically designed to be used with the S5 and M9 ADP systems. It has easy to use, drop-in installation mounts for the ADP and the PCM. Simply insert the components into their corresponding mounts and tighten the thumb screws. The Hydroboard has two hydro-fins to provide increased stability. There are two embedded towing mounts near the front as well as one in the rear for an optional drag chute to increase boat track stability. A detailed description of the mounting procedure for the Hydroboard is explained in Section 3.7.2.



Figure 7. SonTek HydroBoard II with Optional GPS

2.5. **OceanScience Riverboat – Optional**

The OceanScience Riverboat is available for use in environments with higher flow rates. It provides a stable device for accurate measurements by reducing pitch, roll and yaw in flows up to 3 m/s. The flared box design reduces nose-diving and allows for wider selection of acceptable measurement sites.

Section 3. System Configurations and Setup

IMPORTANT NOTE: This section describes only the First Generation Power and Communications Modules (PCM). For information on SonTek's Second Generation PCM, please see **Appendix J**.

3.1. Overview

An important configuration concept to remember is that the RiverSurveyor system and all its components are completely interchangeable. Any PCM can be connected to any S5 or M9 ADP system. The S5 or M9 can be mounted with the PCM to the SonTek Hydroboard or any other boat with a custom installation. We encourage you to become familiar with the components, assembly instructions, and functionality of the system before going into the field. This section provides information on how to interconnect and prepare the system for data collection. The next several figures (Figure 8 through Figure 15) present some typical PCM configurations with system communications and setup details.

3.2. Configuration A – Direct Connection with S5 or M9 Core System

3.2.1. Description

The core system is typically used in a manned powerboat application using a direct cable connection to the PC and the external power supply (Figure 8). The dashed line indicates the use of an optional third party external GPS. The use of an external GPS precludes the use of all wireless communications (i.e. Bluetooth and Spread Spectrum); therefore, a direct connection via serial communications is necessary.

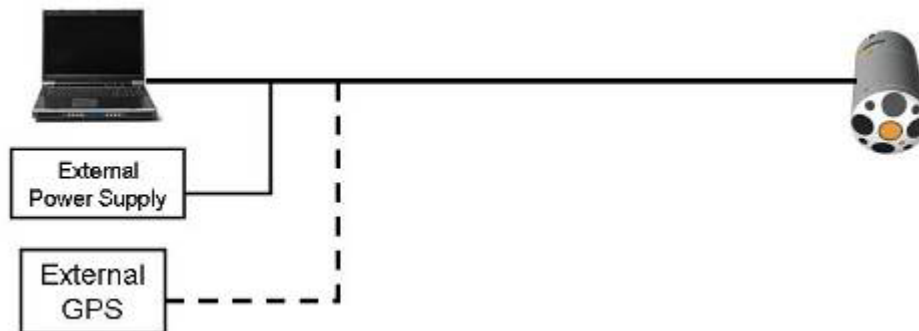

Figure 8. Core System-Direct Connect Setup

3.2.2. Hardware Setup

Follow these instructions to set up the hardware for the core system:

1. Connect the underwater, 8-pin, male connector of the 10-m power and communications cable to the female ADP connector until the face of the cable connector is flush with the ADP connector. Screw-on the locking sleeve to secure the connection.
2. Connect the female, 9-pin, serial connector marked USER on the power and communications cable to the supplied USB-to-Serial adapter. Make sure to manually install the device driver from the manufacturer's website (<http://www.ftdichip.com/Drivers/D2XX.htm>).

3. Mount the ADP to the boat. Be sure to mount the ADP deep enough that the transducers will remain submerged for the entire measurement.
4. Connect the external AC power supply to the system by connecting the 2-pin power cable from the 10-meter power/serial communications cable to the power source.
5. Figure 9 shows the hardware necessary for this option.

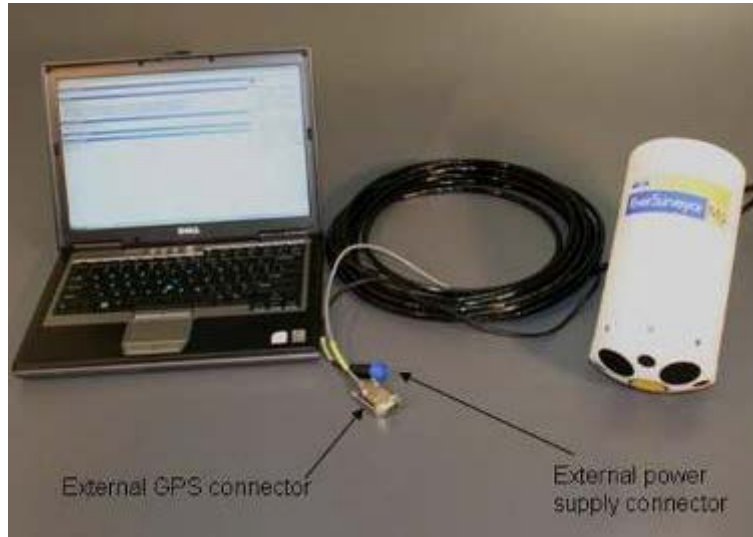

Figure 9. Hardware Required for the Direct Connect Option

6. Start the *RiverSurveyor Live for PC* software and connect to the system to start the measurement. Details for conducting a discharge measurement with a PC are presented in Section 6.
7. To integrate an external GPS system, connect the male, 9-pin, serial connector marked GPS on the power and communications cable to the GPS system. The external GPS needs to have the following settings:
 - Communications Protocol – 38400 N,8,1
 - Data Rate – 10 Hz
 - GPS String – VTG/GGA. To avoid possible communication issues, it is always recommended to turn-off (or disable) any additional GPS strings being output by the external GPS.

3.3. Configuration B – Bluetooth Communications

3.3.1. Description

Figure 10 shows the RiverSurveyor system with wireless communications, in this case Bluetooth, using a small unmanned boat, such as the SonTek Hydroboard. The maximum range using the supplied Bluetooth dongle plugged into a PC is up to 200m. The Bluetooth range of the Mobile device is approximately 60m. Those approximate ranges assume a clear line-of-sight with no obstructions or inclement weather.

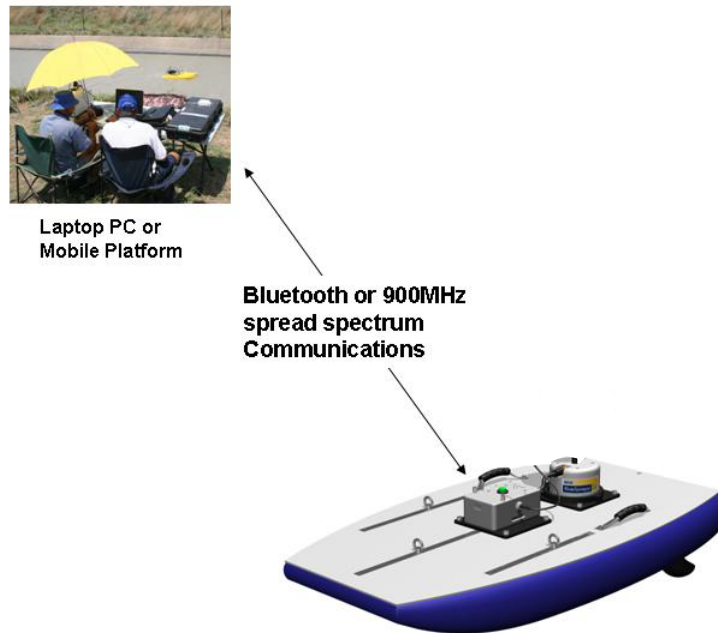

Figure 10. Bluetooth Communications Option (Without GPS)

3.3.2. *Hardware Setup*

Please use the following directions for Bluetooth communications setup.

1. Be sure to use the mounting directions from Section 3.2.2 for the ADP and PCM.
2. Turn on System Power by pressing the white circular button on top of the PCM.
3. The PC requires a connection to a USB-powered Bluetooth dongle into a serial port. A serial to USB adapter is provided for PCs without a built-in serial port. The dongle comes pre-configured and should be recognized as plug-and-play. Note: the Bluetooth dongle requires two COM ports (one for power and the other for communications).
4. The Mobile device requires no external hardware for Bluetooth.
5. The tablet requires no external hardware or pairing.
 - a. On the tablet, open RiverSurveyor Live (or RiverSurveyor Stationary Live) for tablet and tap "Connect to a RiverSurveyor System".
 - b. With Bluetooth turned on, RiverSurveyor Live will start scanning for the instrument.
 - c. After a moment the M9/S5 serial number will appear in the connection dialog box. Select the instrument and tap Connect.
6. The button should then glow solid green, as long as an ADP (M9/S5) is connected to the PCM

Follow the directions outlined in Section 5 to make a discharge measurement.

Figure 11 shows the hardware necessary for the Bluetooth communications option.

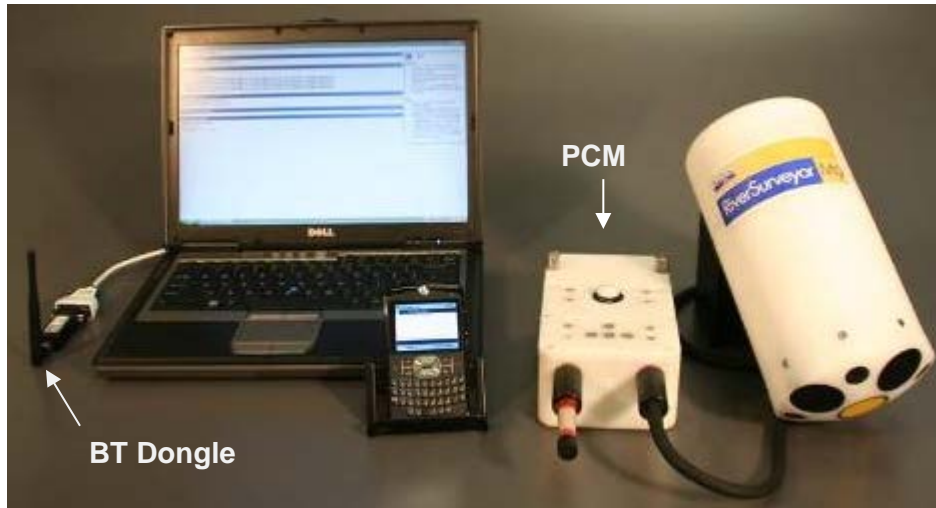

Figure 11. Hardware for Bluetooth Communications Option. Note BT Dongle requires power from a second USB port (not shown).

3.4. Configuration C – Spread Spectrum Communications

3.4.1. Description

Figure 12 shows the RiverSurveyor system with wireless communications, in this case Spread Spectrum communications using a PCM on a small unmanned boat, such as the SonTek Hydroboard. The maximum range of the Spread Spectrum radio link is approximately 2 km.

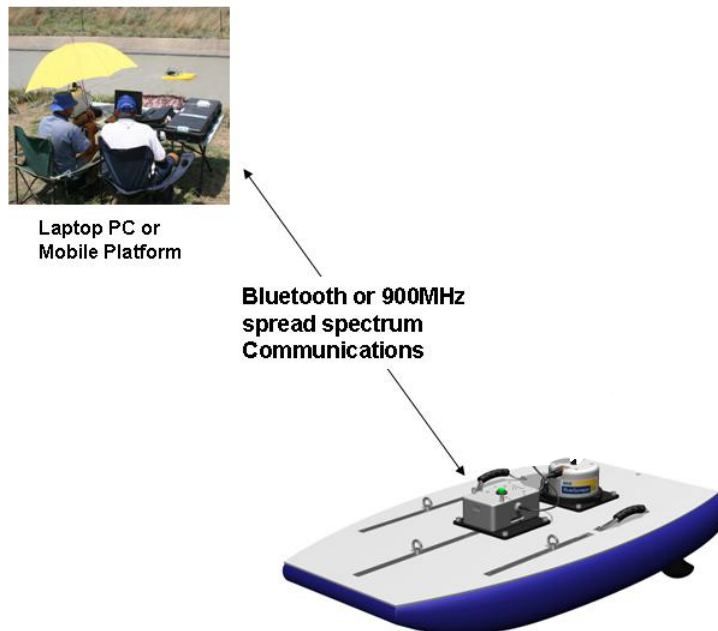

Figure 12. Spread Spectrum Communications Option (Without GPS)

3.4.2. **Hardware Setup**

Please use the following directions for Spread Spectrum communications setup.

1. Be sure to use the mounting directions from Section 3.2.2 for the ADP and PCM.
2. Connect the Spread Spectrum radio box to the PC by using the communications cable. Connect the serial end of the connector to the PC and the 8-pin female connector of the cable to the 8-pin male connector on the radio communications box.
3. Attach the external antenna (not pictured) to the base radio box.
4. Turn on System Power and Spread Spectrum radio box by pressing the white circular button on top of the PCM. The button should then glow solid green.
5. Follow the directions outlined in Section 5 to make a discharge measurement.

Figure 13 presents the hardware necessary for the Spread Spectrum communications option.

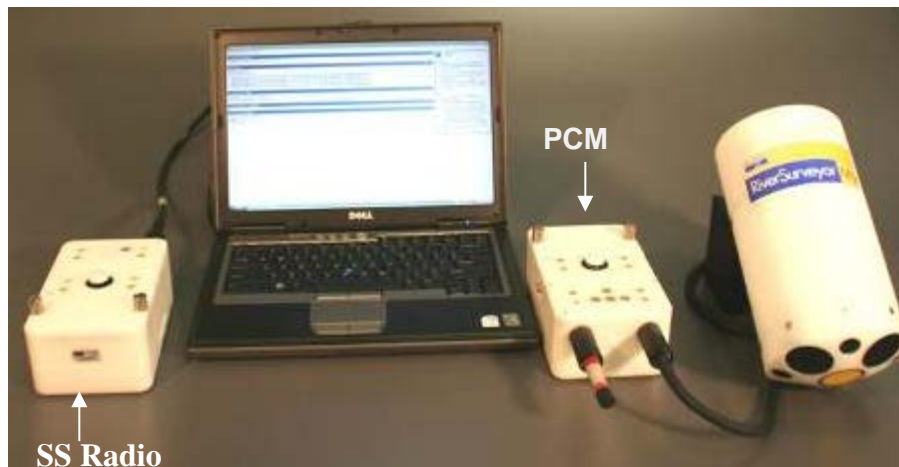

Figure 13. Hardware for Spread Spectrum Communications

3.5. Configuration D – RTK GPS

3.5.1. Description

Figure 14 shows the RiverSurveyor system with RTK GPS (with precision to ± 3 cm) and wireless communications using a small, unmanned boat such as the SonTek Hydroboard. GPS position data is received at 10-hz by both the RTK Base Station and ADP (on the rover). The RTK GPS correction is transmitted at 1-hz from the RTK Base Station to the unmanned boat via Spread Spectrum communications. The SonTek Hydroboard is used below for conceptual purposes.

Note: A sub-meter correction will be maintained up to 45-minutes if communications with the RTK Base Station is lost and after an RTK correction has been established. If the RTK Base Station will not be used for the measurement the user must switch the GPS application to “DIFF” for differential measurements.

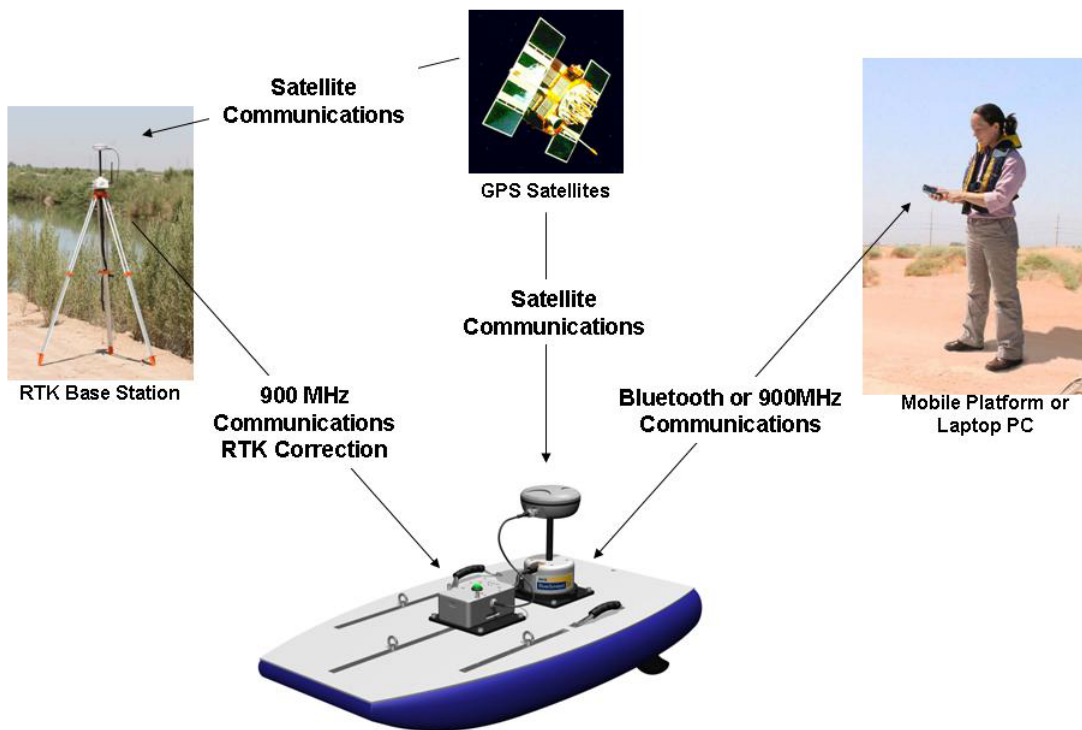
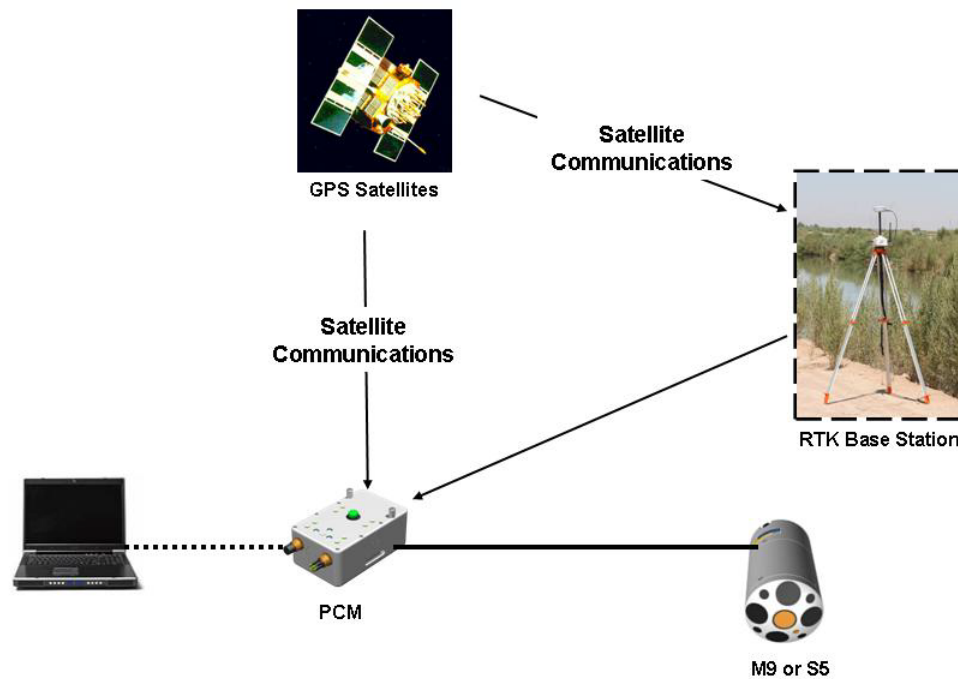

Figure 14. Wireless Communications with RTK GPS

Figure 15 presents a generic or over-the-boat setup using RTK GPS. The setup can utilize either wireless or direct connect communications, which is indicated by the dashed line between the PC and PCM. The dashed line indicates a connection to the PCM in three possible ways:

- Directly to the PCM via a cable for a direct connect configuration
- Connect to the PCM via Bluetooth communications
- Connect to the PCM via SS communications

For the wireless communications option, the dummy plug (8-pin plug) must be inserted into the PCM in order to complete internal circuitry and active wireless communications.



***PC communicates directly with the ADP, via direct connect or wireless communications (laptop PC or Mobile Platform)**

*Note: The "dummy" plug is required in the direct connect port when not using the direct-connect option for PCM to PC connection.

Figure 15. Direct Connect Application with RTK GPS

3.5.2. **Hardware Setup**

There are two components used to collect RTK quality data – the RTK PCM mounted to the boat and RTK Base Station.

Figure 16 shows the Bluetooth option with the RTK option.

RTK PCM (Boat) Assembly

1. Connect the GPS high gain antenna to the aluminum mast by screwing the male threads on the mast into the antenna receiver.
2. Connect the mounting bracket for the antenna mount to the ADP by inserting the four thumb screws located on the mounting bracket into the four brass holes on the ADP.
3. Connect the coaxial cable to the PCM and the GPS antenna by connecting the female connectors on the coaxial cable to the male connectors in the PCM and GPS antenna.
4. Turn the system on by pressing the power button on the PCM.
5. RTK quality data requires that the RTK Base Station be installed within 2 kilometers of the PCM. The RTK Base Station setup is described below.

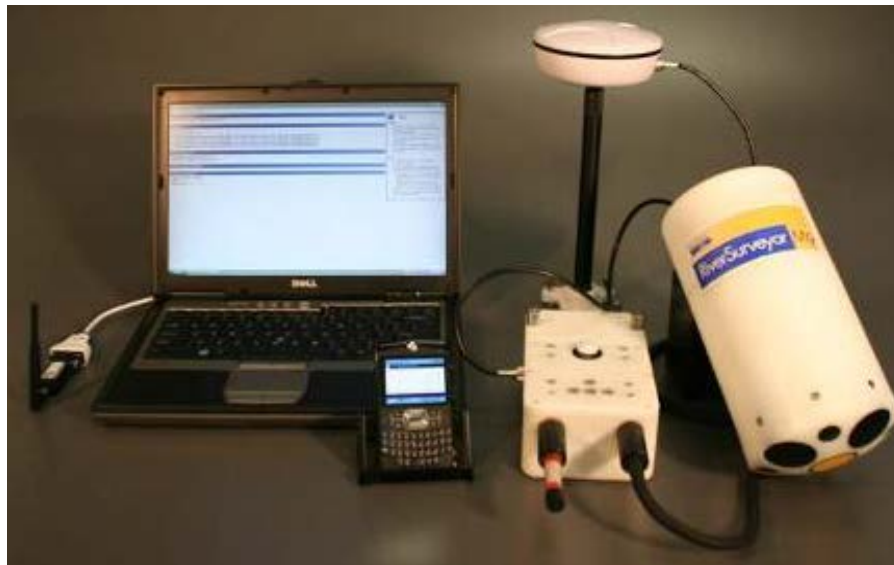

Figure 16. Hardware for RTK GPS Option with Bluetooth Communications. Note BT Dongle requires power from a second USB port (not shown).

RTK Base Station

1. Figure 17 displays an assembled RTK Base Station and tripod. The tripod should be in close proximity to the measurement section (less than 2 km with good line-of-sight) and mounted so that it is reasonably level. Also, nearby obstructions such as bridges, buildings, or large trees should be avoided if possible. These obstructions limit the number of useful satellites increasing the required time to obtain an RTK correction.
2. Attach the tripod adaptor (round plastic disk) to the RTK Base Station until there is a tight fit. Now attach the tripod adaptor to the tripod by screwing the brass thumb screw into the bottom of the tripod adaptor.
3. Attach the Base Station antenna mount to the top of RTK Base Station housing over the brass inserts. Use the four thumb screws on the antenna base mount to secure the mount to the RTK Base Station.

4. Attach the screw-in Base Station antenna mast into the base mount. Screw in the Base Station antenna to the top of the mast. Make sure the antenna is high enough to avoid interference from nearby obstructions like overhead trees, bridges, or buildings. The antenna is typically mounted directly on top of the RTK Base Station; however, it can be dismounted and placed in a more ideal location as long as the antenna's coaxial cable remains connected to the RTK Base Station.
5. Open the RTK Base Station battery cover by loosening the two thumb screws on the battery cover. Insert the rechargeable battery pack by aligning the exposed cells with the spring contacts. Check to make sure the O-ring seal is clear of all debris. When closing the battery cover, securely tighten both thumb screws to maintain a waterproof seal.
6. Connect the SS Radio antenna male connector to the female connector in the RTK Base Station.
7. Plug the male connector of the Base Station antenna cable to the female connector embedded in the RTK Base Station.
8. Adjust the height of the tripod for the best line of sight to the remote PCM.
9. **Important:** If possible, avoid line of sight obstructions as they may decrease the communication range between the RTK Base Station and the PCM (on the boat). If needed, you can add an extension cable between the RTK Base Station and SS Radio antenna to place the SS antenna in a more ideal location.
10. Turn on system power by pressing the circular button on top of the communications box: it should turn solid green once turned on.
11. The RTK Base Station has two LEDs. In all cases, a green light would indicate that the component is functioning while a red/orange light would indicate that the system is not functioning.

00



Figure 17. Hardware for the RTK Base Station

3.6. Configuration E – SonTek Differential GPS

3.6.1. Description

Figure 18 shows the RiverSurveyor system with Standard DGPS and wireless communications using a SonTek Hydroboard. The standard differential GPS option has sub-meter precision. The SonTek Hydroboard is used below for conceptual purposes.

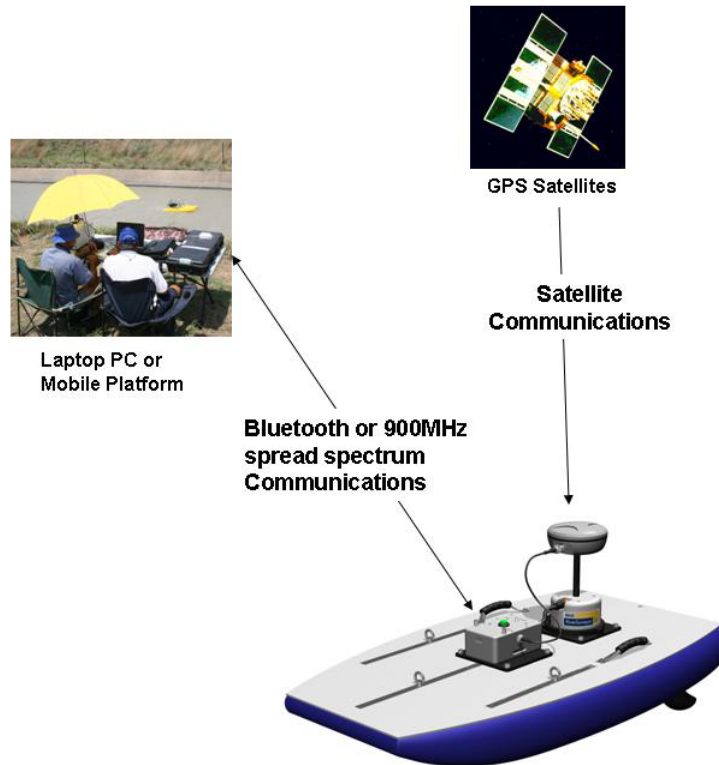

Figure 18. Wireless Communications DGPS

3.6.2. Hardware Setup

Below are the directions for mounting the hardware for the DGPS option.

Figure 19 displays the hardware necessary for the DGPS option.

1. Connect the female connector of the coaxial cable to the male connection on the receiving antenna. Run the coaxial cable through the antenna mast to the bottom, collecting all excess cable from the antenna mast.
2. Attach the GPS receiver to the mast by screwing the female connector of the antenna to the male connector on the mast.
3. Attach the GPS mounting bracket to the ADP by inserting the four thumb screws into the brass holes in the ADP. Now attach the antenna mast to the mounting bracket by screwing the male threads on the mast to the female threads inside the mounting bracket.
4. Connect the female connector of the coaxial cable to the male connection on the PCM.
5. Turn the system on by pressing the power button on the PCM. Follow the instructions in Section 5 to complete the discharge measurement.

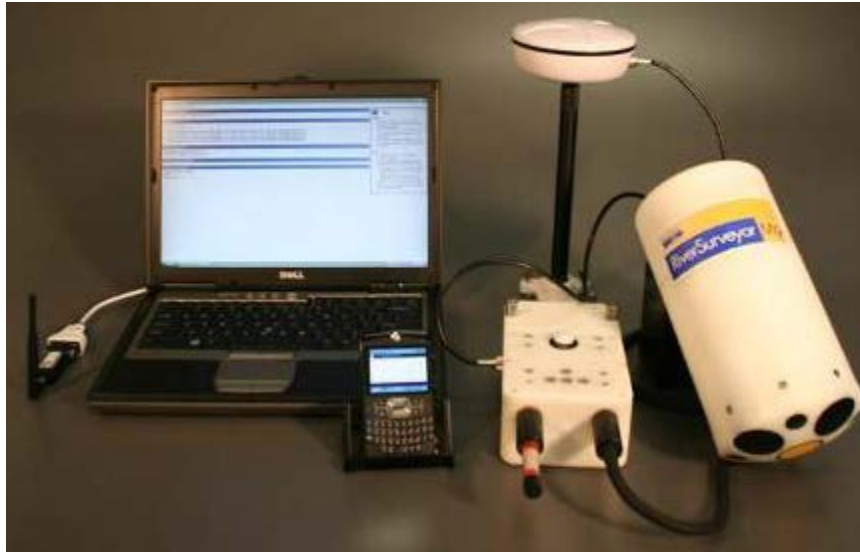

Figure 19. Hardware for the DGPS Option with Bluetooth Communications

3.7. Configuration F - SonTek HydroBoard

3.7.1. Description

The SonTek HydroBoard was designed to be lightweight enough for one person, completely assembled. The Hydroboard has easy to use drop-in installation mounts for the ADP and the PCM. Simply insert the components into their corresponding mount and tighten the thumb screws and/or Velcro straps. In addition, the Hydroboard has two hydrofins that provide increased track stability in water as well as embedded mounts that can be used for towing as well as the incorporation of a drag chute to increase boat track stability.

3.7.2. Hardware Setup

This section describes how to assemble the SonTek Hydroboard components (Figure 20).

1. Open the PCM's battery pack cover by loosening its thumb screws. Insert the rechargeable battery pack by aligning the cells with the contacts. Make sure the O-ring seal is clear of debris. Close the battery cover and securely tighten the thumb screws to maintain a water-proof seal. Set the PCM into position on the Hydroboard (in the rectangular cut-out in the mounting bracket) and tighten its thumb screws or Velcro straps.
2. Insert the ADP face (transducers looking down) into the circular hole in the HydroBoard. Start from the topside of the Hydroboard and move the ADP downward (be sure the top of the ADP coincides with the top of the Hydroboard). If needed, slightly rotate the ADP left and right to raise and lower the ADP to the proper level. To properly align the transducers, make sure the female plug-in of the ADP lines up with the female plug-in of the PCM.
3. The Hydroboard is shipped with a fairing unit preinstalled on its bottom. The fairing is attached to the Hydroboard with four screws that pass through the top of the Hydroboard into the fairing unit on the underside of the Hydroboard.
4. The ADP should be installed so that the transducer head is flush with the fairing. The transducer can be installed deeper if required. Tighten the clamp around the transducer by rotating the thumb screw until the ADP is held firmly in place.
5. The white line on the side of the Hydroboard can be used to calculate the transducer depth. The transducer depth is defined as the distance from the vertical beam to the water surface. The distance for both the S5 and M9 with the fairing to the white line is 4.5 in

(114.3mm). If the ADP head is mounted flush with the fairing, simply subtract the distance of the white line to the waterline from 4.5 inches to get the transducer depth.

6. After the PCM and the ADP are in place, connect the data cable between them. Start by connecting the cable's 8-pin male connector to the female ADP connector until the face of the cable is flush with the connector; now tighten the connection with the protective locking sleeve. Next, repeat the same procedure to connect the data cable to the PCM. Connect the 8-pin male cable connector by pushing the connector into the female connector embedded in the PCM until the face of the cable is flush with the female connector; tighten the connection with the protective locking sleeve.



Figure 20. An Assembled SonTek HydroBoard II (With RTK GPS Option)

7. GPS set-up information is in §3.5 and 3.6.
8. Attach the contoured hydro-fins to the bottom of the Hydroboard. Insert the fins into the slots in the bottom of the Hydroboard with the contour facing the back of the Hydroboard. Firmly tighten the fin to the board by sliding the screw through the small hole in the fin bottom brace. Align the small metal screw clip (in a slide frame) under the hole and firmly tighten the screw.
9. Turn on System Power by pressing the white circular button on top of the PCM. The button should glow solid green.
10. Follow the instructions in Section 5 for completing a discharge measurement.

Section 4. System Maintenance

4.1. Overview

Under normal conditions, the ADP requires little maintenance for years of reliable performance. This section discusses some routine maintenance procedures that should be followed to ensure long-term operation of your system.

4.2. Cleaning the transducers

Periodic cleaning of the ADP transducer face may be needed to maintain optimal performance in areas of high biological activity or mineral build-up. To remove material build-up on the transducer faces, simply clean with a stiff (non-metallic) brush or apply soapy water and clean with a sponge. The transducers themselves are protected in a hard epoxy-resin and are very durable. Minor scratches on the transducer face are normal over a period of time and will not harm them or affect their performance. Direct impacts to the face should be avoided as this might crack the face of the transducer and allow moisture into the electronics housing as well as causing damage to the transducer itself.

4.3. Cables and connectors

Cables and connectors used with the ADP are often the most vulnerable portion of the system. All standard SonTek cables use a durable polyurethane jacket that provides excellent long-term wear and abrasion resistance. Rugged underwater flexible connectors are also used along with high-grade metal connectors to prevent connection failures. However, any cable or connector used in the field is susceptible to damage and reasonable precautions should be taken. Inspect all ADP cables and connectors for damage on a regular basis and replace if necessary.

GPS cables and connectors are industry standard (TNC male to male) and can be replaced if damaged using a local supplier of GPS/survey equipment or by contacting SonTek directly.

For connectors, a light coat of silicone grease or spray is useful in facilitating the connections. However, make sure the silicone does not contain cleaners or solvents that could damage the rubber part of the connector. Inspect both male and female connector pins to make sure they are clear of debris and excess grease, which could interfere with the connection or make it difficult to fully mate the connectors.

4.4. O-rings

Make sure that O-rings on the battery compartment of the PCM are completely clean and free of debris. Be sure that the O-ring is seated correctly, and that it is not twisted or broken. It is important to maintain a water-tight seal for the integrity of the instrument.

4.5. Batteries

The first thing to do with a new system is charge the battery packs. Please use the charger provided. Follow these steps:

1. Plug the charger into the wall and wait for the LED to turn orange.
2. Insert the battery pack into the charging cradle. Be sure the metal contacts on the battery pack are aligned with the metal springs in the charging cradle.
3. The LED should be red while it is charging. A full charge will take about 1-2 hours.
4. Charging is complete when the LED turns green.
5. Remove the battery from the cradle.
6. Wait for the LED to turn orange to charge another battery.
7. Repeat steps 2 through 6 to charge another battery

A description of all the possible light patterns can be found on the bottom of the charger.

It is important to use only completely charged SonTek battery packs. A completely charged battery pack should have about 16-18 volts if you check it with a voltmeter. Be sure the battery pack is completely dry before placing it in the charging cradle. Also be sure the battery compartment in the PCM is completely dry before inserting the charged battery pack. Do not try to modify the battery packs shipped with the product. Third party battery packs will not be supported. Any damage incurred from using a third-party battery pack will void the warranty.

4.6. Tablet

Particularly in inclement weather, be sure to use the clear waterproof bag with the lanyard to prevent water damage. The tablet is not water resistant. Water damage is not covered by the warranty.

4.7. Mobile Device

Be sure to use the clear plastic lanyard with the Mobile device to prevent any water damage in the field. The Mobile device is not water resistant. Water damage is not covered by the warranty.

4.8. Factory Calibration

Each system is individually calibrated during the manufacturing process. Since there are no moving parts and the beams are built into the ADP head, recalibration is not necessary unless the M9/S5 is physically damaged.

Section 5. Introduction to Measurement Procedure

5.1. Overview

This section is a general guide to prepare for and conduct discharge measurements in the field. The information presented here will discuss pre-measurement tests as well as the general procedure for making a discharge measurement.

5.2. Applications

The procedures described in this section are useful for all moving boat discharge measurements made with the RiverSurveyor S5 and M9; this includes the use of the SonTek Hydroboard, custom remote device applications as well as over the boat applications. The protocol described below is applicable to measurements made with the PC and Mobile device software.

5.3. Pre-Measurement Tests

The steps described below are used to test the RiverSurveyor hardware prior to making a measurement. The pre-measurement tests should be done prior to each discharge measurement to ensure the functionality of the RiverSurveyor hardware for proper data collection.

5.3.1. *Check cables and connections*

Prior to mounting the RiverSurveyor hardware, the structural integrity of all cables should be reviewed to ensure that there are no defects; this includes not only the cable but also the connectors. Once the hardware is mounted, connect all the necessary cables. Be sure the faces of the connectors are flush and secure before screwing down the locking sleeves. When using the SonTek Hydroboard or other remote device, be sure that all knots and clamps are sound and that the rope/cord is strong enough to withstand the onsite conditions.

5.3.2. *Communications*

Communications are vital for remote measurements. There are three types of communications connections to the ADP: Direct Connect, Bluetooth and Spread Spectrum Radio. In the case of wireless communications, be sure to have the dummy plug installed in the PCM. It is important to note that the PCM requires power. Be sure to have the battery packs adequately charged and the spare available.

Direct Connect is a cable connection between the ADP and the PC. Confirm that the connection between the cable and the ADP is sound (that the wet mateable connector is flush with the face of the connector on the ADP) and that the locking sleeve is hand tightened. Also make sure that the serial connection to the PC is done with the USB to serial adapter included for PCs, even if your computer has a native serial connector. The external AC power adapter is required for direct connections without a PCM.

Bluetooth communication is available with an optional PCM. It allows for wireless communication between the ADP and a tablet, a PC with the Parani Bluetooth dongle (200m range) or the Motorola Q Mobile device (60m range).

Parani Bluetooth Dongle – This is an external Bluetooth radio that plugs into a PC serial port or through the USB to serial adapter. The dongle requires power from the PC through the included USB connector. It is automatically configured to 57600 baud by the *RiverSurveyor Live* software. In all cases, be sure to verify sound connections.

Spread Spectrum Radio provides extended range (up to 2 km). The optional PCM communicates with the Spread Spectrum base that plugs into a PC serial port via an 8-pin wet mateable connector. There is a USB to serial adapter included for PCs without a DB9 serial port and SonTek recommends using it instead of native Serial ports. The Spread Spectrum base radio is

battery powered, so be sure to have fully charged batteries and to turn it on prior to starting the discharge measurement.

5.3.3. **System Test**

This is a 60 second verification that the components of the hardware are functional. The System Test verifies the battery voltage, compass, SD memory card and temperature sensor are all functioning properly. A system pass would indicate that all systems are sound for use, while a fail would require user action in order to conduct reliable discharge measurements. Below is a list of the system Fail messages:

- ❖ System battery voltage < 12 volts
- ❖ System compass is not working
- ❖ System SD card (memory) is not working
- ❖ Temperature sensor is not working

5.3.4. **Compass Calibration**

Compass calibration is necessary prior to each discharge measurement. It is used to compensate for magnetic interference in the vicinity of the ADP. A battery or steel clamp right next to the unit will have a much greater effect than, for example, a steel bridge 200 m away. That's why it is important to eliminate any magnetic material, including electronic/mobile devices and wristwatches from the immediate vicinity when performing a compass calibration.

To perform a compass calibration, rotate the ADP slowly through two complete circles while smoothly varying the pitch and roll through the greatest tilt angles possible and practical. Each rotation must take no less than one full minute to complete and must be done slowly.

If the ADP is to be mounted on a boat, the *entire* boat needs to be rotated for the calibration, along with everything that is physically attached to the system, while varying the pitch and roll smoothly through the greatest tilt angles possible and practical. Changes to metal components on the boat (such as toolboxes, engines or mounts) should not be made after the calibration is done, otherwise, the calibration is invalid and must be repeated.

If a good calibration score cannot be achieved, try to reduce the speed of the rotations and increase the pitch and roll as much as possible. It may be necessary to complete the compass calibration by hand on the boat as close to the mounting location as possible. Heading corrections can be made in post-processing if necessary.

IMPORTANT NOTE: Please review the important details about the software feedback and how to perform a proper compass calibration in Section 6.11.1.

5.3.5. Recorder

The Recorder Menu is provided on the Systems Tab and provides a way of managing files stored on the 16 GB memory card. You can download all or a selection of files by using the options presented in the Recorder window.

Download all files – downloads all files from the recorder

Download selected files – allows you to select files using the tick box next to the file name. Simply select the files to download and then click on Download selected files.

Format Recorder – Clears the memory of the recorder by erasing all files.

Make sure that there is adequate memory available on the recorder prior to making a discharge measurement. It is suggested to download files and format the recorder between measurement sites. All files must be downloaded from the ADP for post-processing and data evaluation.

5.3.6. Measurement Procedure

Now that the pre-measurement tests and initial site-specific entries are complete, it's time to understand the basic principles behind a discharge measurement. Basically, the total discharge is the amount of water flow (or net flux) through a section and is computed from the mean water velocity and the cross-sectional area of the measurement section.

5.3.7. Overview

A single moving boat measurement of discharge can be broken into three key components: The Start Edge, the Transect and the End Edge. These components are shown in Figure 21 below:

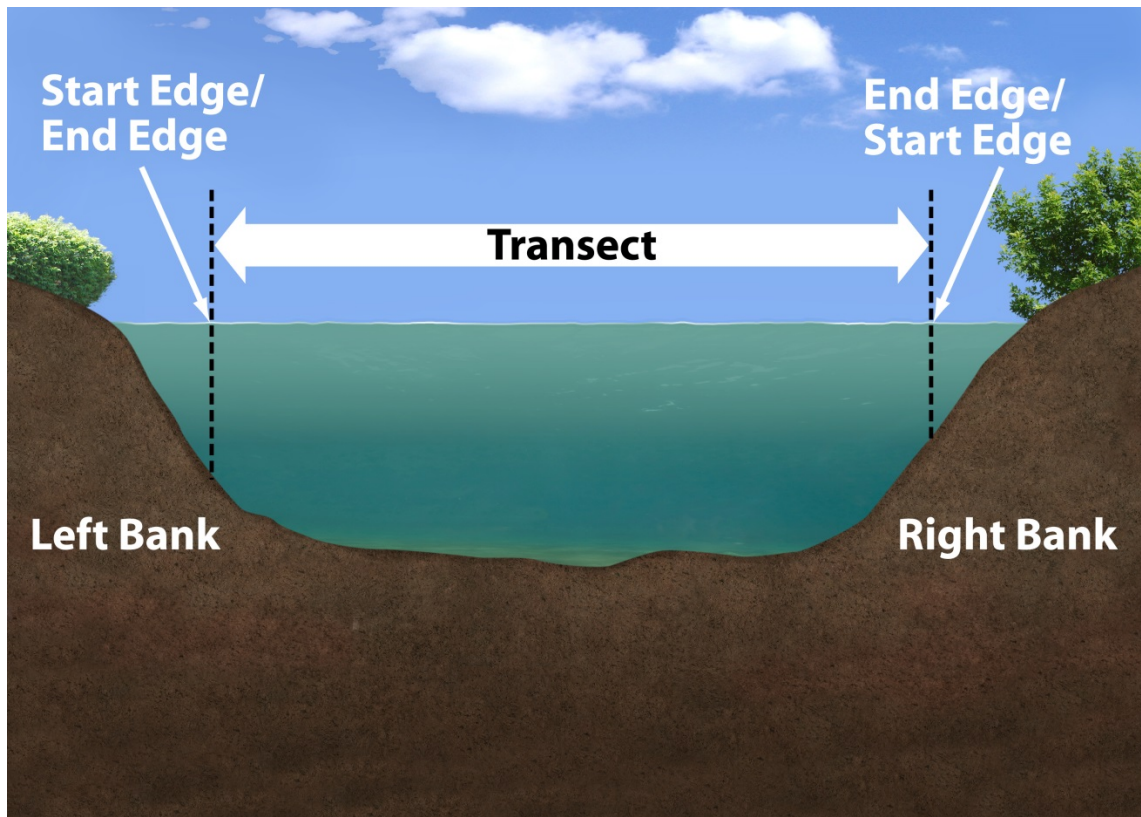

Figure 21. Measurement Sections

The Transect component can be further broken up into the Top Estimate, Middle or Measured Area and Bottom Estimate as shown in Figure 22 below:

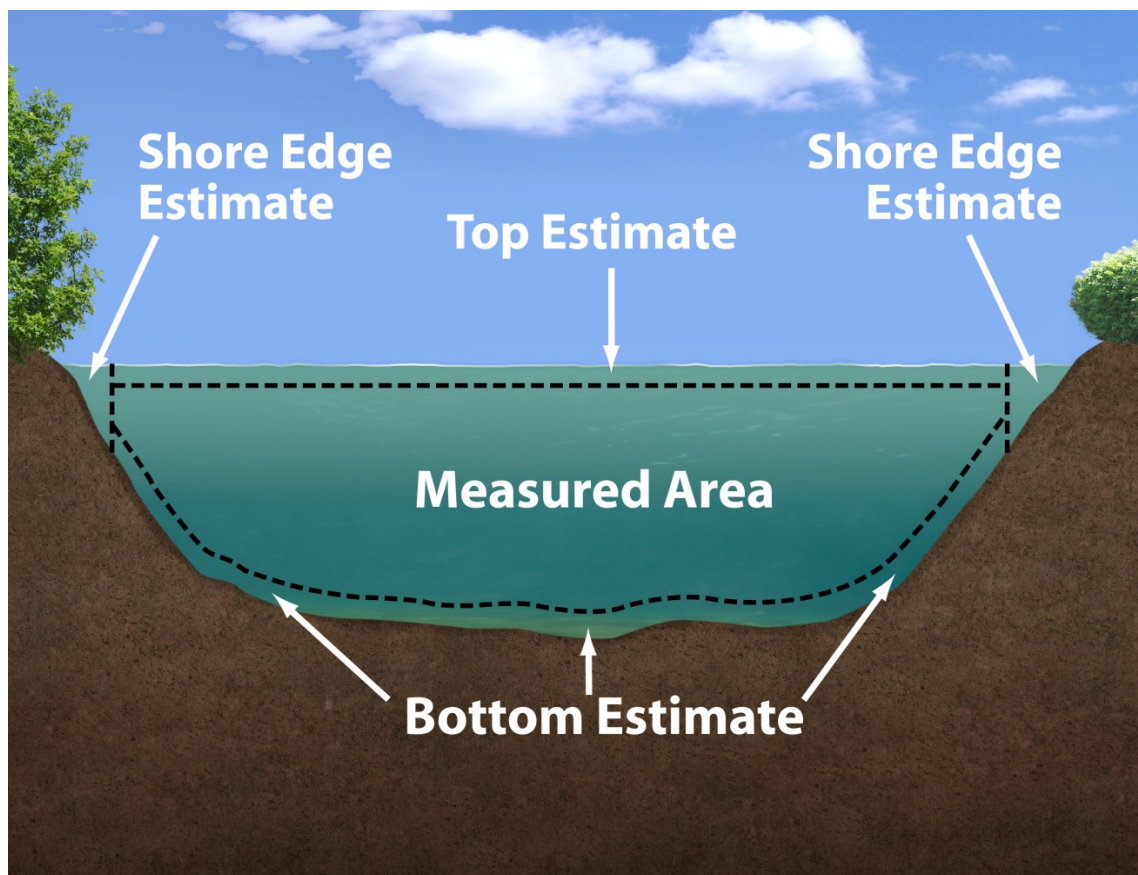

Figure 22. Cross-Sectional Areas Not Measured by the ADP

Therefore, the Total Discharge can be calculated by summing the Start Edge, Top Estimate, Measured Area, Bottom Estimate and End Edge. Only the Measured Area is measured by the acoustic Doppler profiler. It is important to note that all other areas are estimated using industry recommended and approved calculations.

The reasons for breaking up the total discharge calculation into several components are due to limitations inherent in all acoustic Doppler profilers. An acoustic Doppler profiler cannot measure the entire river cross-section due to several issues:

- There is a minimum operating depth for the profiler. At depths lower than this minimum, the water velocity and therefore the discharge must be estimated based on the velocity and depth measurements on the edges. The Start and End Edges are measured in this way.
- The mounting depth plus a short distance (referred to as the blanking distance) from the profiler to the start of the measured velocity profile leave a section of the water at the surface unmeasured. This area is referred to as the Top Estimate.
- Potential data contamination in the last cell (i.e., the cell is partially or fully “touching” the riverbed), or potential side-lobe interference at the end of the profile, leaves a section of water at the bottom unmeasured. This area is referred to as the Bottom Estimate.

So, how do we calculate the velocities and discharges in each of these estimated and edge areas?

A technique known as Velocity Profile Extrapolation is used to estimate the unmeasured areas at the top and bottom. This theoretical approach to modeling of the velocities within the water column allows all velocities and therefore the discharge to be computed.

Velocity Profile Extrapolation uses a power law velocity profile proposed by Chen (1991), and Simpson and Oltmann (1990), to calculate velocities above and below the Measured Area.

$$\frac{u}{u_*} = 9.5 \cdot \left(\frac{z}{z_0} \right)^b$$

Equation 5-1. Velocity Profile Power Law

Where u is the velocity at height z measured from the river bottom, u^* is the bottom shear velocity, z_0 is the bottom roughness height, and b is a constant (equal to $1/6$ according to Chen, 1991). Use of this equation assumes the currents in the profile are traveling in approximately the same direction. In situations where this may not be the case, (e.g., Stratified Flows or bi-directional flow), one of the other extrapolation methods, available in the *RiverSurveyorLive* software, should be used. By default, the *RiverSurveyorLive* software uses the $1/6$ th Power Law velocity profile (described above) using the entire measured velocity profile to calculate velocities in the top and bottom unmeasured areas.

The velocities are now known for each of the estimated top and bottom areas. The discharges for each component are calculated based on the velocities, depth and movement of the vessel across the transect.

The discharge in the Start and End Edges is calculated from a mean velocity profile that is developed by maintaining a (relatively) fixed position at the edge. It is important that the vessel be kept as stationary as possible at the edge. The velocity profiles measured at this time will be combined together to produce a single average profile. The discharge calculation at the edge is based on the selection of a constant sloped bank or vertical wall and uses a combination of the mean depth and velocity profile at the edge.

In the Transect, the discharge calculation is based on the depth, distance travelled and the mean water velocity. During this time the system automatically compensates for changes in the vessel course and speed.

One of the key benefits is that the PC and mobile software step through this entire process and do the calculation of discharge automatically.

5.3.8. **Starting the System**

After the system is configured, start the system collecting data.

5.3.9. **Collecting Start Edge Data**

Position the vessel for the starting edge position and begin collecting edge data with the vessel as stationary as possible. It is recommended that a minimum of 10 profiles/samples are collected to perform the edge discharge calculation. Enter the edge distance and shape.

5.3.10. **Collecting Transect Data**

After collecting the start edge data, proceed to move the vessel across the channel. Keep the vessel speed and direction as constant as possible.

5.3.11. ***Collecting End Edge Data***

After moving across the channel and arriving at an end edge location, enter the end edge distance and shape. Collect at least 10 samples/profiles with the vessel as stationary as possible.

5.3.12. ***Making Additional Measurements/Transects***

After entering the end edge information, the measurement is complete. Another measurement can be started from the same location or the system can be shut down.

Section 6. RiverSurveyor Live for PC & Tablet Software

6.1. Overview – RiverSurveyor Live for PC Software

This section is a quick reference for using the *RiverSurveyor Live for PC* and *RiverSurveyor Live for Tablet* software. The *RiverSurveyor Live* software is a discharge measurement interface for RiverSurveyor S5 and M9 systems. The software includes everything needed to make real-time discharge measurements as well as post-process the data.

6.2. PC System Requirements

RiverSurveyor Live for PC requires the following minimum specifications for the PC:

- Windows 7 – 10
- 1.6 GHz processor
- 1 GB memory
- 1 GB disk space
- 1280 x 800 Screen Resolution

6.3. Tablet System Requirements

RiverSurveyor Live for Tablet requires the following minimum specifications for the tablet:

- Windows 8 – 10
- Intel® Atom™ Processor
- 2 GB memory
- 32 GB disk space
- 1280 x 800 Screen Resolution

IMPORTANT NOTE: The Dell Venue 8 Pro has been tested for full compatibility. Other tablets meeting these specifications not supplied by SonTek may work, but they are not supported.

6.4. PC Software Installation

To install the *RiverSurveyor Live for PC* software on your PC, insert the distribution CD into your CD-ROM drive. The program should automatically start and display the Installation Menu (Figure 23). If the installation menu does not appear in a few seconds, click Start|Run on your PC and type D:\install.exe, where D:\ is the letter of your CD-ROM drive.

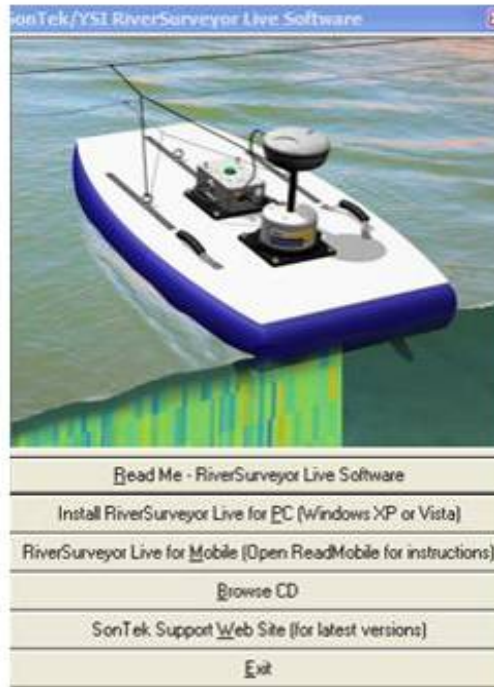

Figure 23. Installation Menu

Click the *Install RiverSurveyor Live for PC* option. The installation wizard (Figure 24) will display step-by-step instructions to install the software.

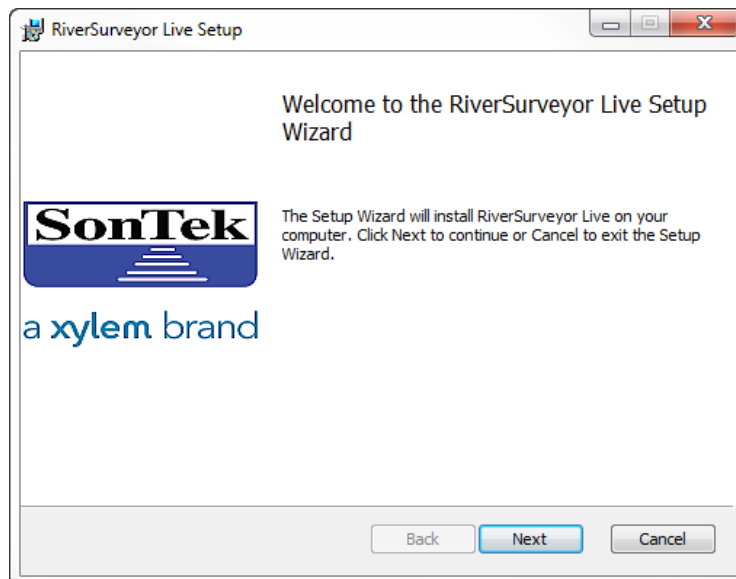

Figure 24. Desktop Installation

Beginning with RiverSurveyor Live v3.90, there is an option to enable a USGS Screening Distance feature during the software installation. The feature automatically applies a screening distance of 0.52 ft more than the transducer depth. Details of this feature can be found on the USGS Hydroacoustics website. It is disabled by default as indicated by a red X shown below:

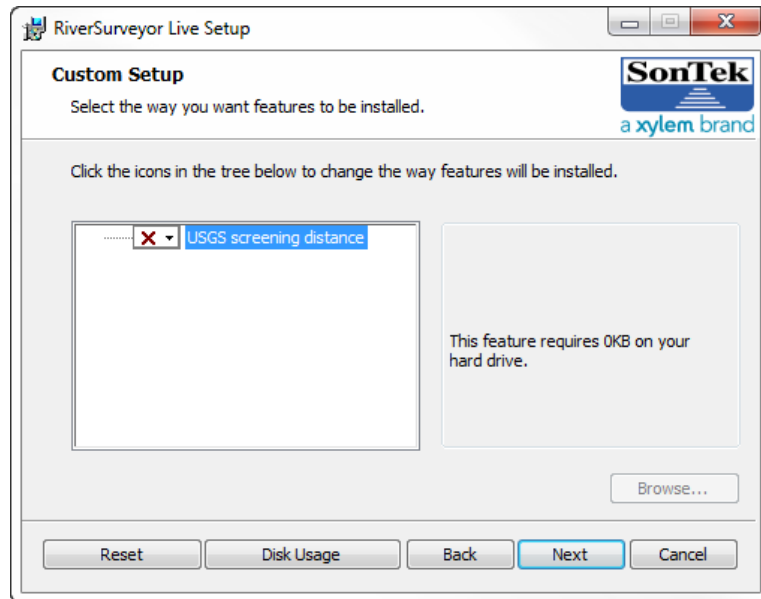

Figure 25. USGS Screening Distance Disabled

To enable the feature, click on the drop-down arrow and select Install Feature as shown below:

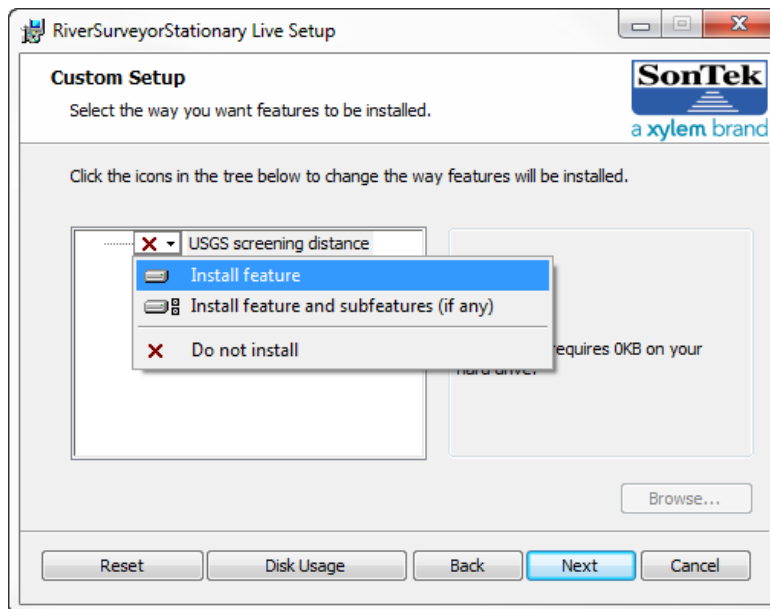

Figure 26. Enable USGS Screening Distance

Follow the on screen instructions to complete installation of the software. You are now ready to use *RiverSurveyor Live for PC* to make a measurement.

6.5. Tablet Software Installation

To install the *RiverSurveyor Live for Tablet* software on your tablet, download the software from <http://www.sontek.com/software-archive/index> or copy the *RiverSurveyorLive* folder from a PC using a USB flash drive. Double tap on the *RiverSurveyorLive_ForTablet_Setup.exe* (or *.msi) file. The program should automatically start and display the Installation Menu. Follow the on-screen instructions to complete installation of the software. You are now ready to use *RiverSurveyor Live for Tablet* to make a measurement.

Tablet display mode enlarges fonts and icons. Tablet display mode is enabled if the software detects it is running on a tablet. Tablet display does not allow for window re-sizing and thus the option to switch modes.

6.6. Starting the Software

Upon starting the software, the main menu will be presented as shown in Figure 27 below:

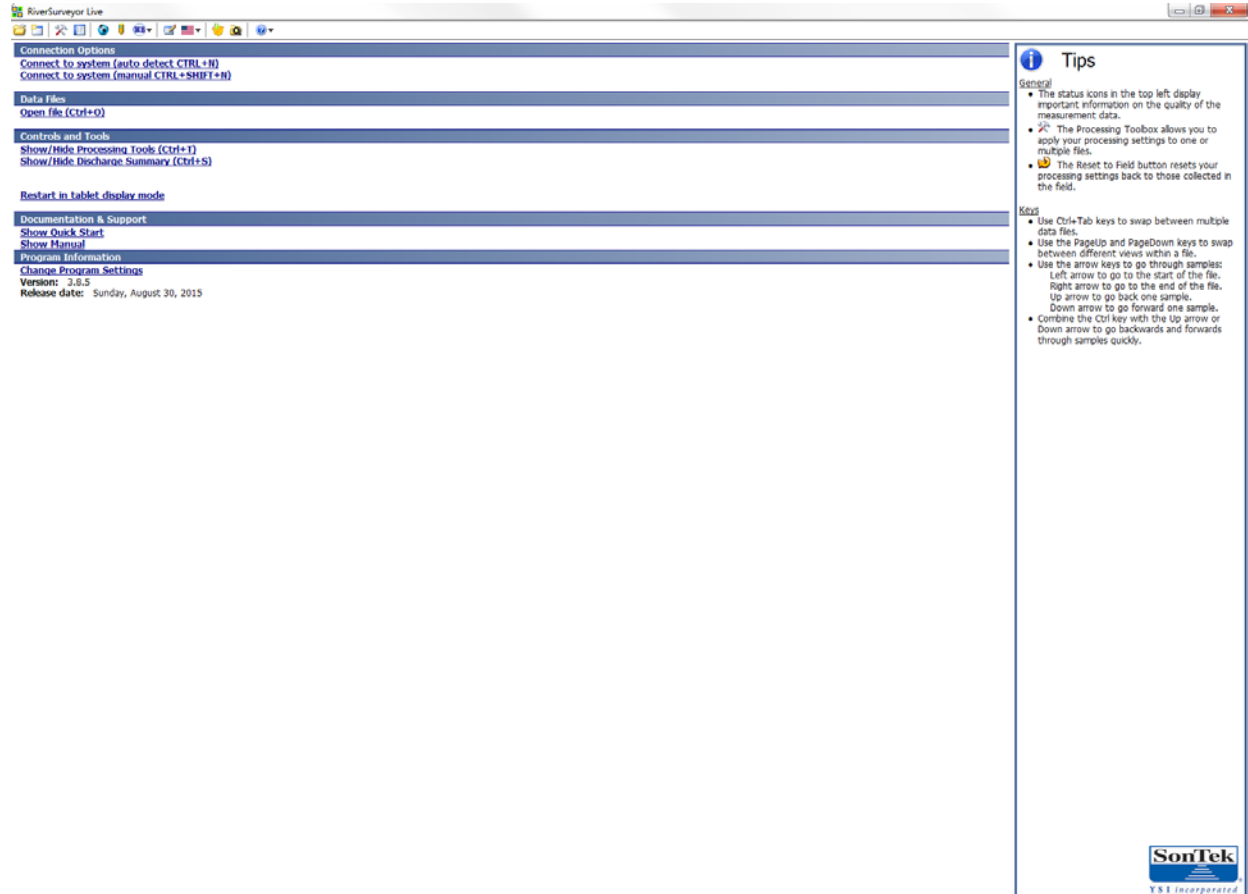

Figure 27. RiverSurveyor Live Main Menu

6.7. Connecting to the System

There are three ways to connect to the ADP using the *RiverSurveyor Live for PC* software.

- Click the Connect icon on the toolbar at the top of the screen



- Use one of the *Connect to system* links under Connection Options
- Use the hot keys: CTRL+N (auto detect) or CTRL+SHIFT+N (manual)

Clicking on the Connect icon or the Auto Detect CTRL+N link will open a window to select a system serial number available for connection. Highlight the serial number and click Connect as shown below.

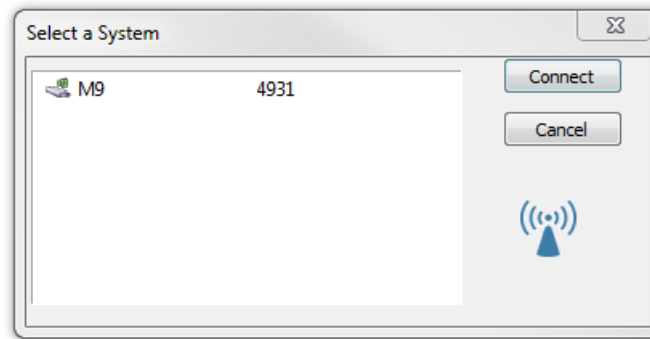

Figure 28. Select a System

Alternatively, clicking on the Connect to System (Manual CTRL+SHIFT+N) will open a window to select a COM port by number. Check the Parani Radio button if using the Bluetooth serial radio with a first generation PCM. Check the SonTek Radio button if using the 2.4 GHz USB radio with a second generation PCM.

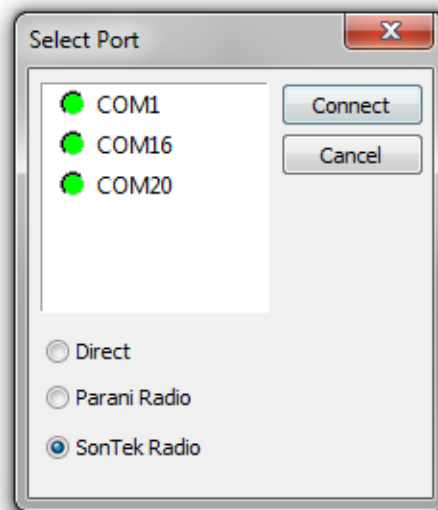

Figure 29. Select COM Port

A Warning message will appear if the M9/S5 doesn't have the latest firmware installed. The firmware can be downloaded from www.sontek.com.

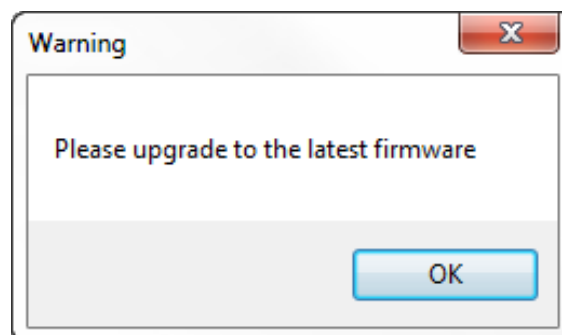

Figure 30. Firmware Upgrade Warning

When the connection is established, the SmartPage is displayed as shown in Figure 31. This tab allows you to enter Site Information, System Settings and Measurement Settings; download files from the Recorder and perform Pre-Measurement Tests. The COM port and baud rate (COM2 57600) are shown at the top.

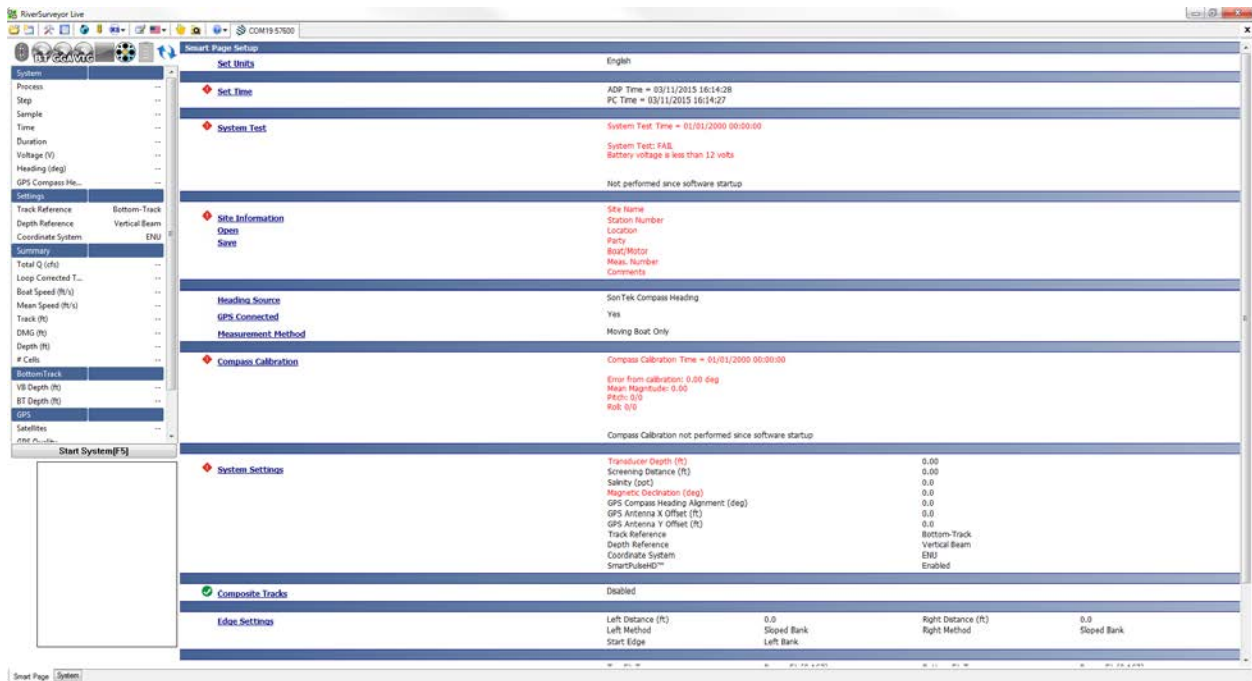

Figure 31. Smart Page Following Connection

6.8. Site Information

Site information can be entered by clicking Change Site Information. This opens a popup window that allows you to enter site specific details. (Figure 32). The maximum number of characters allowed for each data field is in parentheses. Entering more than the maximum allowable characters will display an error message that will prompt you to enter the information within the allotted number of characters. This information can be changed during post processing.

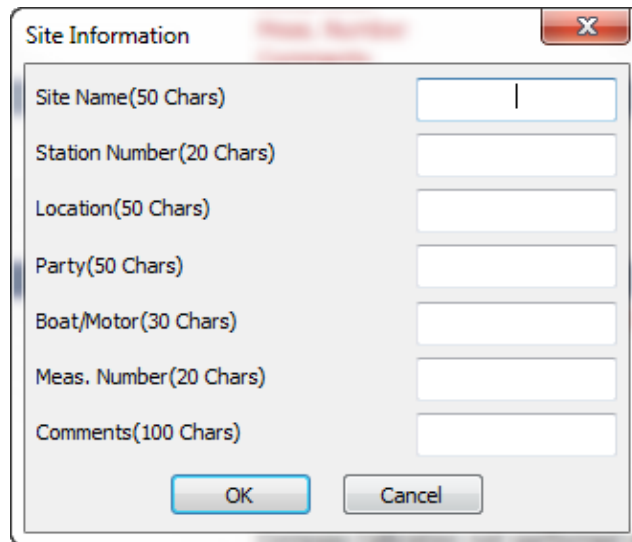

Figure 32. Site Information Menu

6.9. System Settings

System settings are specific to the measurement site. The information is entered by clicking Change System Settings. This will allow you to enter setup information for the site as well as select the Track Reference, Depth Reference and Coordinate System. Figure 33 presents the System Settings menu. This information can be changed during post processing. The data changed in post-processing will be indicated with green text. Below is an explanation of each field in the System Settings menu.

Figure 33. System Settings menu

Transducer Depth – This is the distance (m) that the vertical beam transducer is submerged below the water surface. Figure 34 shows a basic diagram that depicts an ADP’s transducer face submerged in water. Transducer depth corresponds to the depth of water that the transducer face is submerged.

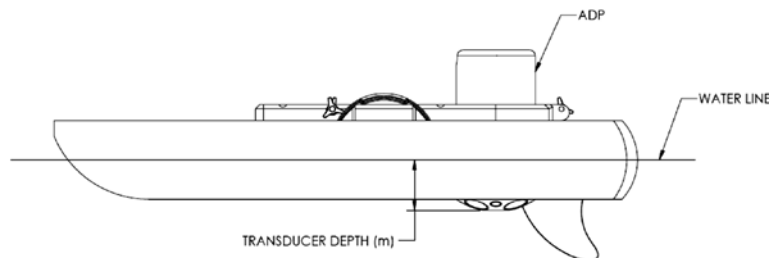

Figure 34. Explanation of Transducer Depth Measurement

Screening Distance – This is the distance below the water surface that you want to start collecting data rather than relying on the default setting of the instrument. This setting allows you to program the ADP to start collecting data below a certain point. This is primarily used for boat mounted applications where the screening distance can be set to avoid flow disturbance from the wake of the boat. Note: An accurate Transducer Depth is required.

$$\text{Screening Distance} = \text{Transducer Depth} + \text{depth to screen below instrument.}$$

Salinity – This user-defined parameter allows for a correction of the speed of sound in water based on the salinity in parts per thousand (ppt) at the face of the ADP. A value representative of the local water conditions must be entered manually to avoid potential erroneous calculations. For reference, the salinity range is between 0 ppt (freshwater) to 45 ppt (seawater). Water temperature is also a factor for speed of sound in water calculations. The ADP has a built-in temperature sensor that automatically compensates for this effect.

Magnetic Declination – On the earth's surface, a calibrated compass indicates magnetic North rather than geographic North. The angular difference between these two directions is called magnetic declination (also known as variation, magnetic variation, or compass variation). Magnetic declination varies across the earth's surface and over time. The ADP compass is calibrated at the factory; however, calibration is required at each site to remove any local magnetic interference. Compass calibration will ultimately give better measurement accuracy. The magnetic declination angle (θ) can be found on maps, like the one presented in Figure 35. Magnetic declination resources can also be found on many sites on the internet.

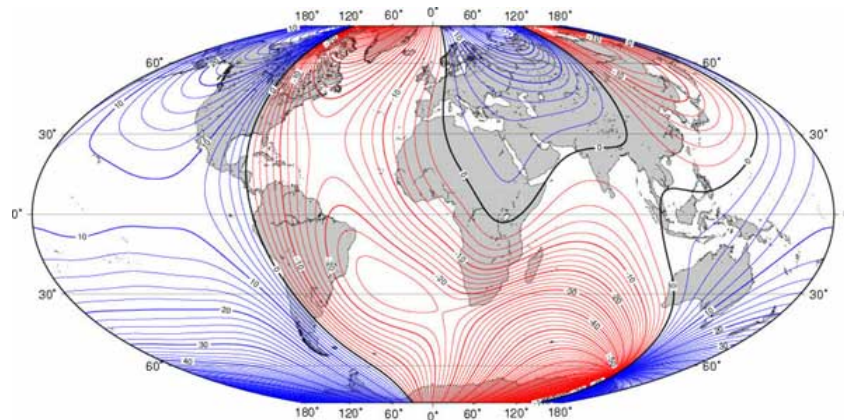

Figure 35. Magnetic Declination Map of the World

GPS Compass Heading Alignment – If an optional GPS Compass is connected and it cannot be aligned with the positive X-axis on the M9 (in line with the connector), this field allows the user to compensate for the angle between the two headings.

GPS Antenna X/Y Offset – These fields can be used when the GPS antenna is not located directly above an M9/S5. That is often the case when a GPS antenna is mounted on top of a boat.

Track Reference – The ADP measures a water velocity using the Doppler shift principle, using multiple acoustic pulses transmitted and received throughout the water column. When the ADP is in motion, the water velocity measured by the ADP is a combination of boat velocity and water velocity. In order to determine true water velocity, the boat speed must be known and then

subtracted from the actual water velocity measurement. The RiverSurveyor “moving boat” discharge application uses three methods (references) to determine boat velocity.

1. **Bottom-Track reference velocity:** The ADP itself can determine boat speed using a technique called “Bottom-Track”. In this case, bottom-track velocity is calculated using the Doppler shift received from multiple acoustic pulses (transmitted from the ADP) that have reflected off of the riverbed. If the riverbed is stationary (i.e. non-moving bottom), then the Doppler shift velocity will consist entirely of boat speed velocity which is acceptable for discharge calculations. If the riverbed is in motion the Doppler-shift-based velocity will consist of both boat speed and riverbed speed which will bias discharge calculations. In this case, the following two references would be preferred to determine boat velocity.
2. **GGA GPS-referenced velocity:** GPVGGG (GGA) refers to a specific NMEA-0183 protocol for outputting GPS position data. In this case, the GGA “string” contains actual position (latitude/longitude) information along with several other GPS quality parameters. Boat velocity is calculated by measuring the distance between two successive GGA positions divided by the travel time between those two positions. Differential corrections are required for the GGA data to reduce the amount of position error associated with each measurement. The RiverSurveyor uses two types of differential corrections: “Sub-meter” differential and “Real-Time Kinematic” (RTK).
3. **VTG GPS-referenced velocity:** GPVVTG (VTG) refers to a specific NMEA-0183 protocol for outputting GPS velocity data. In this case, the VTG string contains the actual boat speed information along with several other GPS parameters. The GPS velocity is calculated based on the Doppler shift of the received satellite signals.

There is a drop-down menu to select the appropriate track reference. All available track references will be available for analysis or to recalculate discharge in post-processing. There are four options:

- **Bottom-Track:** The ADP uses the bottom-track feature to measure the velocity of a vessel relative to the river bottom. The vessel velocity is then subtracted from the measured water velocity to give the absolute water current profile independent of vessel motion. This is the only track reference available for systems without an optional GPS.
- **GPVGGG:** The ADP uses the GGA string (from the GPS data) to measure velocity of a vessel based on GPS position data. This is only available for systems configured with a GPS option. It is recommended that GGA data use a sub-meter differential or RTK correction for discharge calculations. The highest quality and most accurate method applies RTK-corrected data.
- **GPVVTG:** The ADP uses the VTG string (from the GPS data) to measure the velocity of a vessel based on GPS velocity data. This method requires additional review of data quality parameters to verify data quality.
- **System:** The ADP references all velocities only to itself. This should only be used in specialized applications by experienced users. It is ***not recommended*** for discharge measurements from a moving vessel.

Depth Reference - This is a drop-down menu that has two options for determining water depth. Both options are available for post-processing, however you can decide the default measurement.

- **Vertical Beam:** This is highly accurate echo sounder data used to determine water depth.
- **Bottom-Track:** This uses data from the four angled beams to determine the depth of the water column using the average depth from each beam.

Coordinate System - This drop-down menu has three options. All three options are available for post processing; however, you can set the default for the measurement.

- **ENU:** This is the traditional East, North, and Up coordinate system.
- **System:** This uses the ADP as a reference. Used for internal testing only.
- **XYZ:** This is a three-dimensional “relative position” coordinate system used only for specialized applications by experienced users.

SmartPulseHD™ – This feature is Enabled by default to optimize performance in the widest range of conditions. General details can be found in Appendix F. It is only recommended to Disable this feature when a Manual Configuration is desired by an experienced user (See Section 6.11.11).

6.10. Edge Settings

Edge Settings can be entered by clicking Edge Settings on the Smart Page. They apply to the specific discharge measurement. The information from this menu (Figure 36) can be changed in post-processing. Below is an explanation of the fields for the Edge Settings window:

- **Start Edge** – Sets the default starting edge for discharge measurements (right or left bank).
- **Left/Right Method** – Sets the bank type for the discharge measurement.
- **Left/Right Distance** – Sets the distance from the beginning/end of the measurement transect to the bank.
- **Estimated flow** – Computed flow for the specified edge.
- **Start/End Gauge Height** – Allows user to record the gauge height at the beginning and end of the measurement.
- **Start/End GH Observation Time** – Allows the user to record the time of the gauge height measurements.
- **Auto-Edge Profiles** – Enables automatic switching from collecting the edge measurement to the transect after a user specified number of edge samples. The default and recommended number of edge samples is 10.
- **Show Edge Dialog** – When checked the edge dialog box is shown and it is possible to change edge settings. When unchecked the edge dialog box does not pop up after clicking Start/End Edge and the edge settings specified on the Smart Page are used.

Figure 36. Edge Settings Menu

6.11. Pre-Measurement Tests and Utilities

The steps described below are used to test the RiverSurveyor hardware prior to making a measurement. The pre-measurement tests should be done prior to each discharge measurement to ensure the functionality of the RiverSurveyor hardware for proper data collection.

6.11.1. **G3 Compass Calibration**

IMPORTANT NOTE: This section describes only the G3 compass calibration introduced in 2014 (FW/SW v3.80 and later). For information on calibrating a system with an earlier compass, please refer to Appendix K.



TO ENSURE DATA QUALITY WHEN REFERENCING A MEASUREMENT TO GPS, PLEASE READ CAREFULLY THE INSTRUCTIONS CONTAINED IN THIS SECTION

When making a discharge measurement using the RiverSurveyor S5 or M9 system, the system's internal compass (or an external heading sensor, such as a GPS Compass – see Appendix E) is used to provide the instrument's heading as it moves across the channel. Unlike a GPS Compass, the M9/S5 internal (magnetic) compass must be calibrated prior to data collection.

A proper user-performed compass calibration at the field measurement site prior to collecting data is a critical step for avoiding heading errors during the measurement, as the compass calibration is used to compensate for localized magnetic interference in the vicinity of the instrument. If heading errors are observed during the measurement, then a review should be performed of the methodology used for the compass calibration, and of the local surroundings where the calibration was performed for potential sources of magnetic interference, in order to locate the cause(s) of the heading errors. If your instrument is equipped with a G3 compass, a time series of the magnetic error can be plotted to identify variable magnetic interference affecting the heading error at a site.

A primary consideration is that the internal (magnetic) compass calibration is designed to be representative of the conditions that will be experienced during the actual measurement. When calibrating the compass, the RiverSurveyor S5/M9 should be rotated through two complete circles while varying the pitch and roll smoothly through the greatest tilt angles possible and practical. **The keys to a proper compass calibration are slow rotations in a relatively low magnetic field, using the maximum pitch and roll angles possible for the boat or floating platform used during actual data collection.** For example, if the measurement will be performed at a site with flat surface water conditions, then a compass calibration using smaller pitch and roll angles may be sufficient (but NOT totally flat). However, if the boat or floating platform will be experiencing large pitch and roll angles during the measurement, then the calibration needs to be performed using large pitch and roll angles during the rotations. If smaller pitch and roll angles are used during the compass calibration procedure than what will be experienced during the actual measurement, there will be the potential for significant heading errors. Conversely, calibrating the compass using significantly large pitch and roll angles and then making the actual measurement where very small pitch and roll angles will be experienced could also lead to heading errors.

In addition, the pitch and roll angles applied during the calibration should be done at a relatively slow rate (such as what one might use when operating/panning a video camera). Varying the pitch and roll angles too quickly or erratically will cause the RiverSurveyor S5/M9's internal accelerometers to report unrealistic heading values for a given calibration point, resulting in significant calibration errors.

It is also important that the compass calibration be performed in the same environment as where the actual measurement will be performed. For example, it is not adequate to perform a calibration in a parking lot far from the water's edge, or on a concrete bridge deck far above the water surface, etc. In addition, prior to the calibration it is important to look around to ensure that there are not any sources of magnetic interference in the area where the compass calibration will be performed. Potential sources of interference include large ferrous metal objects, metal hulled vessels, concrete structures with rebar, power transmission lines, automobiles, etc.

Specific calibration instructions follow:

1. Prior to the calibration, all magnetic material or sources of interference should be removed from the immediate vicinity, such as cell phones/mobile electronic devices, wristwatches, keys, hand tools, etc.
2. If the RiverSurveyor will be mounted on a floating platform, the compass calibration must be performed with the system installed on the platform along with the other components. If the RiverSurveyor will be used from a manned boat, the compass calibration must be performed using the entire boat with the RiverSurveyor mounted in the exact place and orientation in which it will be used during the actual measurement. If possible, the compass calibration should be performed at the same boat motor speed as will be run during the measurement. Everything that will be physically attached to the RiverSurveyor system during the actual measurement must be treated as part of the system and therefore rotated along with the S5/M9.
3. The RiverSurveyor S5/M9 and boat/floating platform should be rotated through two complete circles.
4. The pitch and roll angles should be varied during the rotations. For the best calibration results, the angles used should be similar to what will be experienced during the measurement transects. When making a measurement, it is important to keep in mind that the calibration will only be valid over the same pitch and roll angles experienced during the compass calibration procedure. **It is critical that the variation in pitch and roll be done SLOWLY. The internal compass uses accelerometers (similar to those used in modern video-game consoles) and as such can generate erroneous tilt angles should the system's tilt be varied too fast during the calibration routine. A typical rate is about 2-3 seconds to go from one tilt limit (e.g. high positive roll) to another (e.g. high negative roll).**
5. After the calibration, there must not be any changes made to the position of engines or mounts, or any other metal components on the boat, such as toolboxes, electronic devices, etc. If any position changes are made, the compass calibration should be repeated so that the system can account for the new, current, magnetic field affects.

To calibrate the compass, click on “Compass Calibration” on the Smart Page tab. The following window will appear. Click the Compass Calibration link and click Start in the pop-up window or View to view the results of a previously recorded compass calibration.

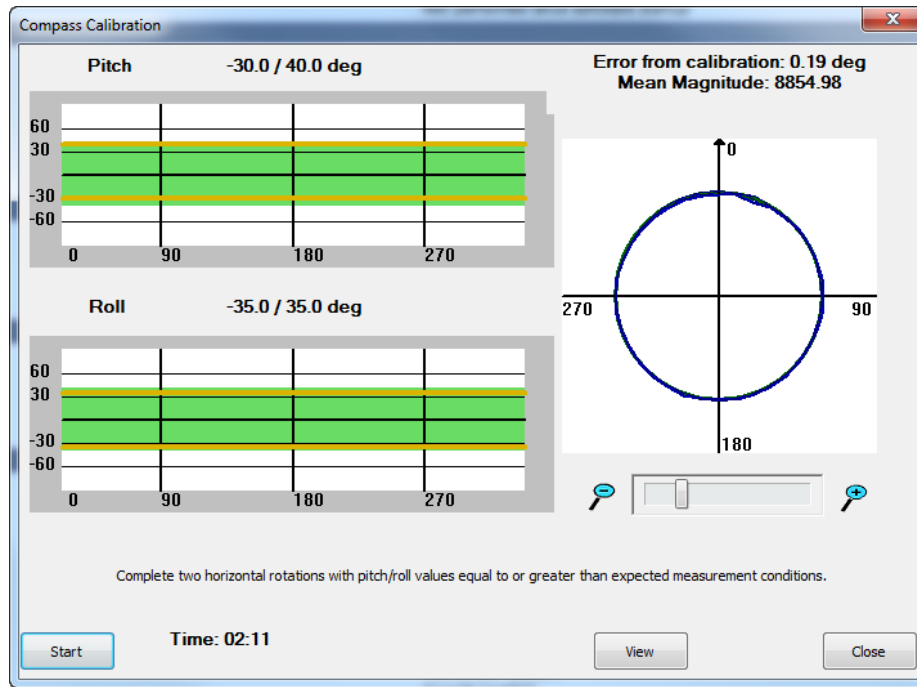

Figure 37. Compass Calibration window. Depending on the version of the compass firmware in your system, you may also be asked to input the max pitch and roll angles expected during the measurement.

Click **Stop** upon completion of the compass calibration procedure. The calibration results and feedback are displayed in the window below.

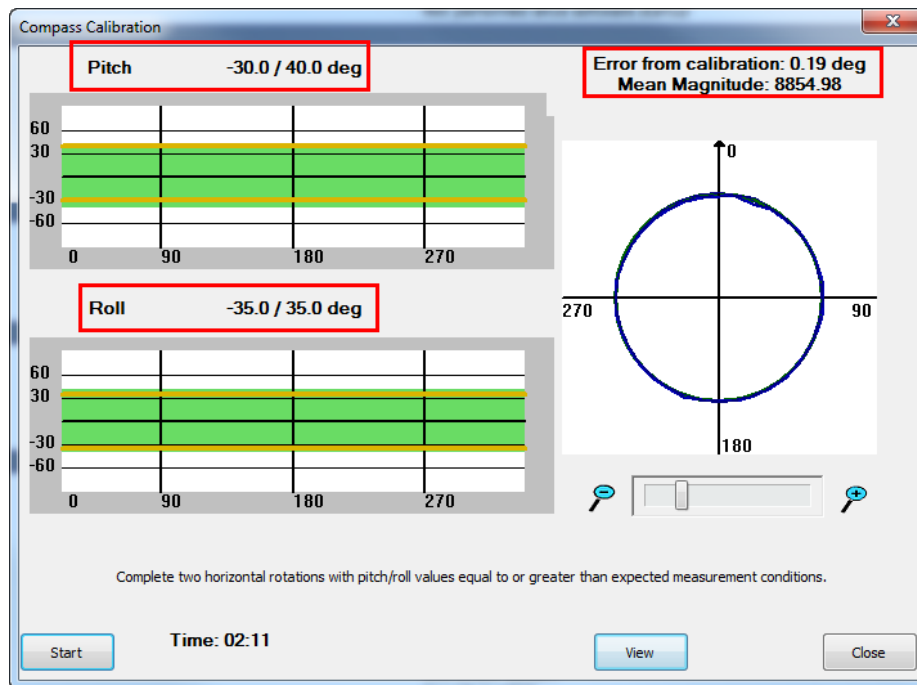

Figure 38. Upon completion, the results will be displayed above the plots.

6.11.2. **Compass Calibration Feedback**

1. **Error from calibration (degrees)** - This is a statistical measure of the quality of the calibration. Lower is better. Larger values mean the equations that were fit to the calibration data don't actually represent the calibration data very well. This could mean, for example, that you had metal moving relative to the compass during the calibration (e.g., phone in your pocket, truck driving by, snap hook swinging on the Hydroboard) or there was a varying electrical field during calibration (e.g., boat motor revving).
2. **Pitch and Roll (degrees)** - The pitch and roll range that was induced during calibration. This range should exceed what is expected during the measurement.
3. **Mean Magnitude** - This is the mean value of the magnetic field measured during calibration. No units.

For 3D calibrations (including pitch/roll), this value depends on the magnetic field strength both from the instrument and from the surrounding environment. For example, an S5 and an M9 calibrated side-by-side will have different Mean Magnitudes. But, two consecutive calibrations from an M9 should be about the same. Likewise, two consecutive calibrations from an S5 should be about the same. If you take an M9 and go gauge the same site every week, you should see about the same Mean Magnitude each time. If the Mean Magnitude changes, that's a clue to look for a metal that has been tossed into your river or buried in the bank.

A good compass calibration will include an **Error from Calibration value <0.5 deg** and cover the range of pitch and roll expected to be experienced during the measurement. If the **Error From Calibration value >0.5 deg**, the compass calibration will fail and will not be stored in the instrument.

6.11.3. **Compass Quality During Measurement**

1. **Magnetic error (%)** – A new addition with the G3 compass is the ability to plot a time-series of magnetic error both in real time and in post-processing. Magnetic error is the percent difference between the magnetic field during measurement and the mean field seen during calibration. A magnetic error equal to 3.5% indicates that you may be introducing a heading error of up to 2 deg. **Lower is better**. A high value means the magnetic field is different than it was during calibration. For example, the M9 might be crossing a buried pipe, you might have changed the transducer depth since calibration, the boat motor might be revving, etc (Figure 39).

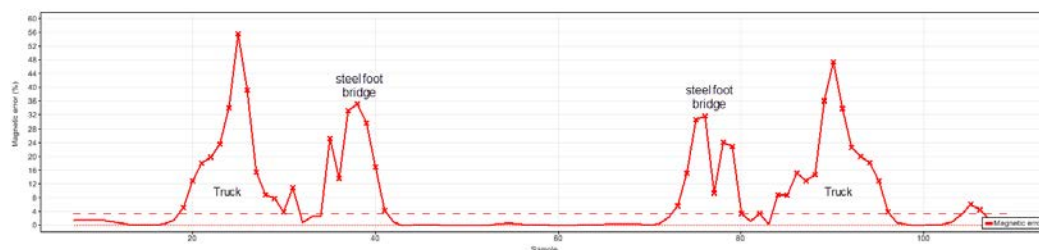

Figure 39. Magnetic error time series plot showing high magnetic error %.

2. **Compass Alert** – Another new addition with the G3 compass is a compass alert notification. If during a measurement the **magnetic error** exceeds 3.5% and/or the **pitch and roll** values exceed the range covered during calibration, the compass alert box will turn

red and count up, one for each sample that exceeds these criteria (Figure 40). A magnetic error equal to 3.5% indicates that you may be introducing a heading error of up to 2 deg. On the real time plot of magnetic error, the horizontal dotted line indicates the 3.5% threshold and each sample that exceeds this threshold will be marked with a red X and increase the real time **Compass Alert** count by 1.

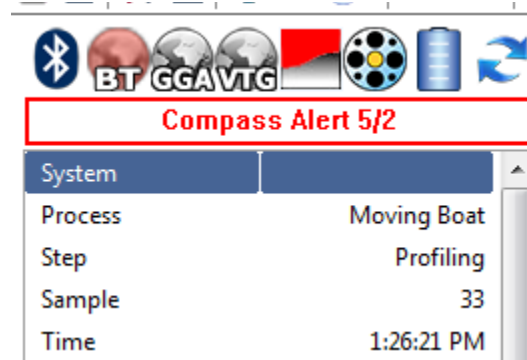

Figure 40. Compass Alert box shown. In this case there have been 5 samples with magnetic error >3.5% and 2 samples with greater pitch and/or roll value than experienced during calibration.

6.11.4. **System Test**

The System Test performs a series of checks to confirm the battery, compass, recorder and temperature sensor are in good operating condition. Click **Start** to initiate the test (Figure 41). The test typically takes 60 seconds and will present a dialog window indicating a system test Pass or Fail. A failure would indicate that user action is required to ensure proper functionality of the system.

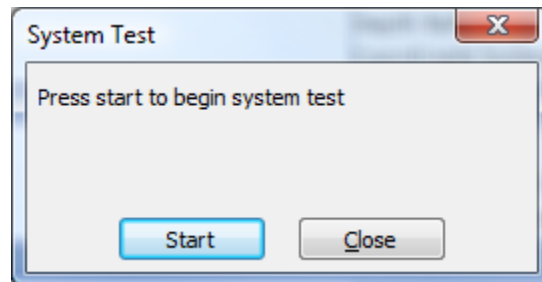

Figure 41. System Test Window

Below is a list of the following system Fail messages:

- System battery voltage < 9.5 volts (PCM2) or <12 volts (PCM1)
- System compass is not working
- System SD card (memory) is not working
- Temperature sensor is not working

6.11.5. **Set Time**

Set Time allows you to verify and set the time used for the discharge measurement. The popup window allows you to click the check-box to use the PC time or set the time manually (Figure 42). Click the **Set Time** button to apply the time setting and close the window.

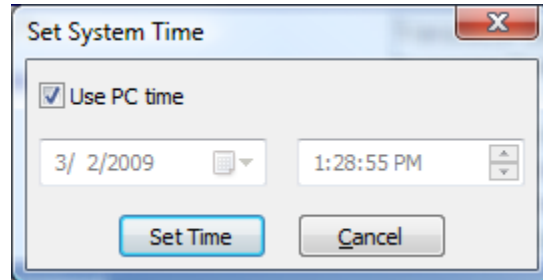

Figure 42. Set System Time Window

6.11.6. **BeamCheck**

BeamCheck displays the SNR (Signal to Noise Ratio) of each beam versus range. Click the BeamCheck link to start the utility. A popup window (Figure 43) will appear displaying the serial number of the system and the selected beam frequency.

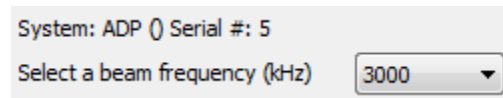

Figure 43. BeamCheck Menu

Beam check will start automatically for the selected beam frequency showing a plot of each beam (Figure 44). The other beam frequencies can be selected from the drop-down menu as the system runs.

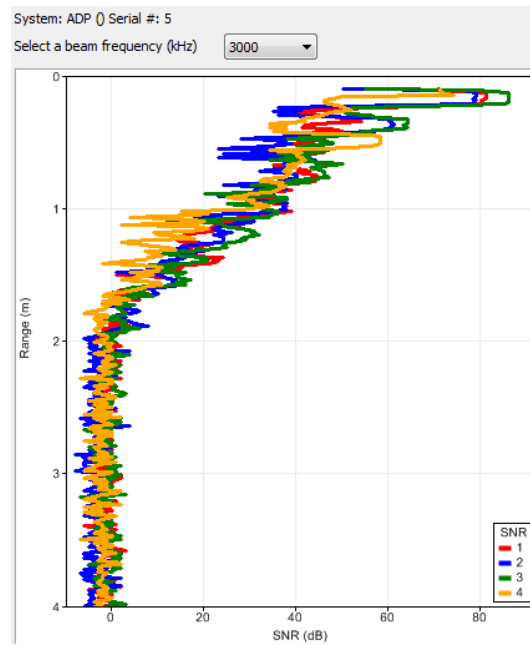

Figure 44. BeamCheck Graph

6.11.7. Update Firmware

This allows users to update firmware from the utilities window by selecting a file from the PC. Typically users can download new firmware files (.a79 extension) from the SonTek webpage. After finding the file on the PC, select “Open” to load the firmware file to the ADP. After the update is loaded, make sure that the firmware version is correct in the Systems Tab.

6.11.8. SonTek GPS Option

The SonTek GPS Option provides information about SonTek GPS options available. Clicking this option in the Utilities menu provides a way of verifying the GPS options available. If the GPS option is not available, this will be indicated in a dialog window. If the SonTek GPS application is RTK and you want to change to Differential (DGPS), click Change to Diff. Changing from Differential GPS to RTK GPS works in the same way (Figure 45). It is important to note that the SonTek DGPS option is not upward compatible with the SonTek RTK GPS option as it requires a more advanced hardware. There is no capability of integrating a shore-station differential GPS correction. The SonTek GPS options use the WGS84 horizontal datum.

Beginning in 2022, with PCM model number PCM-I-13 and higher, the SonTek GPS Option automatically switches between DGPS and RTK without the need to manually change it as described above. When the SonTek GPS Option is clicked it will indicate that it is automatic as shown in Figure 46.

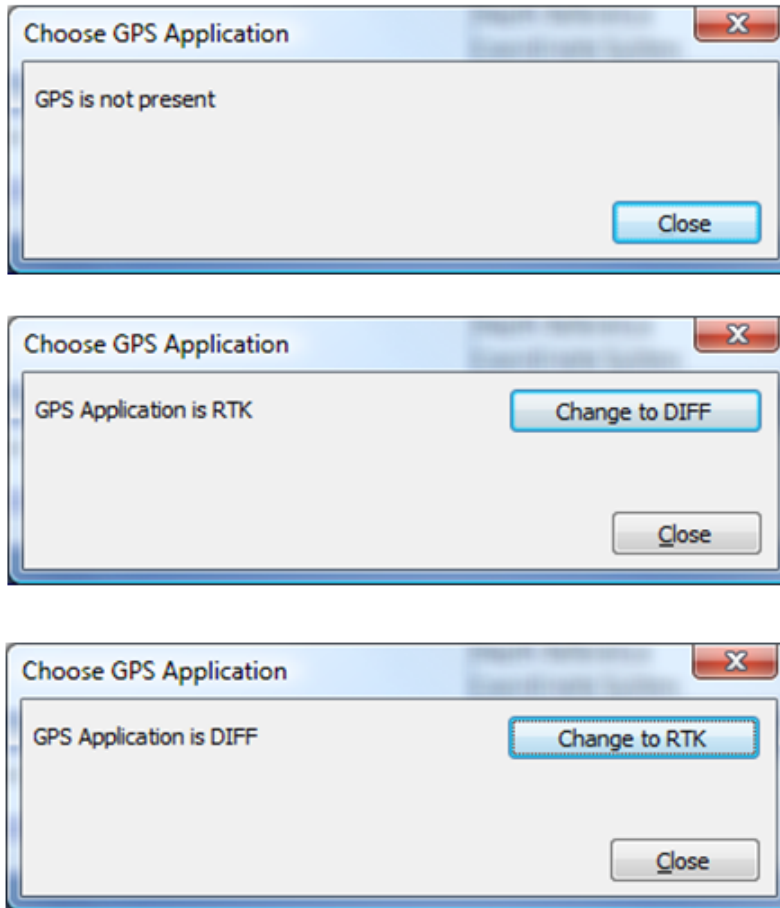

Figure 45. SonTek GPS Option Menus

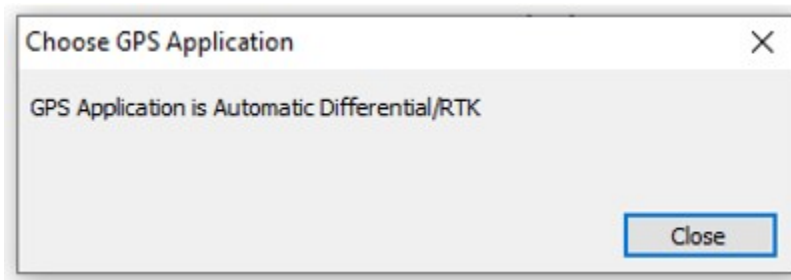

Figure 46. Automatic GPS Application

6.11.9. **Loop Method**

This allows users to collect a “Loop Method” file to correct discharges biased by a moving bed. The background and procedure are described in 8.5.Appendix H.

6.11.10. **SMBA Method**

This allows users to collect an “SMBA” file to correct discharges biased by a moving bed.

6.11.11. **Manual Configuration**

Manual Configuration allows the user to manually configure RiverSurveyor systems Incoherent (IC) profiling mode. The manual configuration gives the user the option to select between two different frequencies and configure the Cell Size, Cell Count and Blanking Distance.

RiverSurveyor SmartPulse processing is enabled by default when a new measurement file is created and need to be disabled before Manual Configuration is used to configure the RiverSurveyor instrument. SmartPulse can be disabled on the “Smart Page” under system settings in RiverSurveyor Live Software.

The Manual Configuration feature is available on the “System Page” under Utilities in the RiverSurveyor Live software. The feature can be opened by selecting “Manual Configuration” link displayed on the system page.

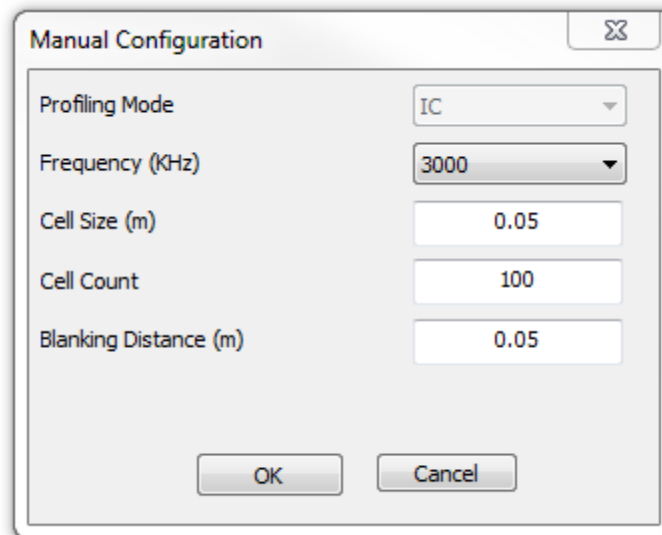

Figure 47. Manual Configuration

The selection of the appropriate Frequency, Cell Size, Cell Count and Blanking Distance is based on the flow conditions and channel geometry. It is recommended that a standard measurement is performed using SmartPulse to determine the criteria for manual configuration.

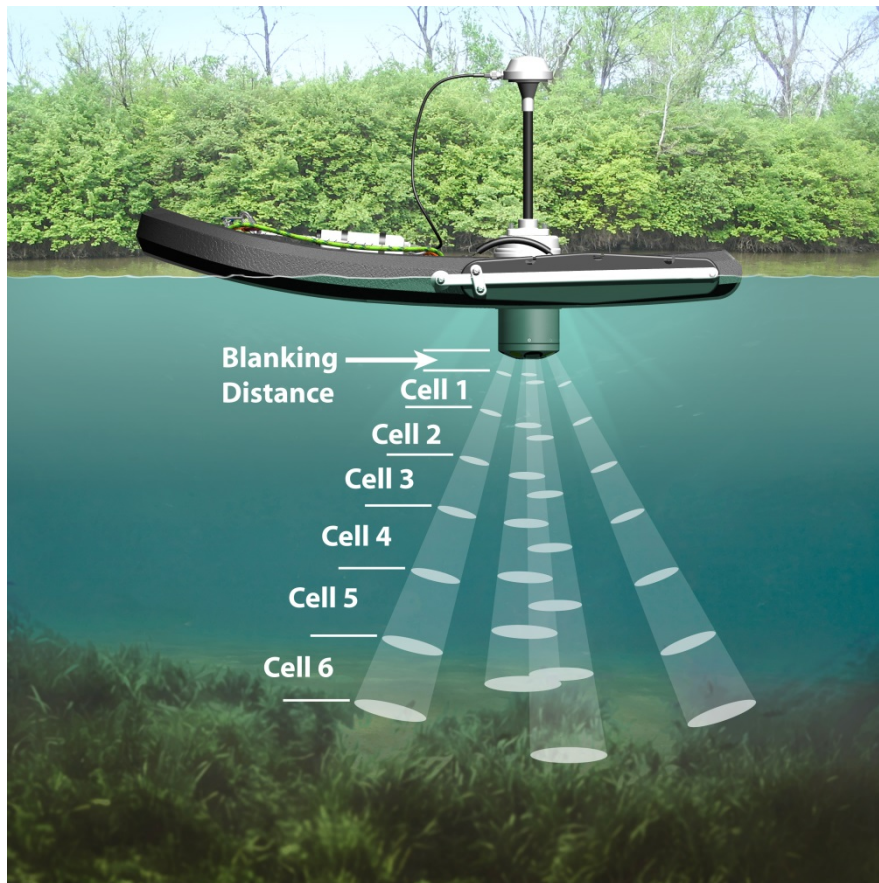

Figure 48. Cell Locations

The profiling range determined from the Blanking Distance, Cell Size and Cell Count should account for the following measurement principles:

- **Minimum 2 Cells:** The blanking distance and cell size should be chosen to operate in shallow water areas in measurement section. Minimum of two cells are required to perform an accurate velocity measurement within the profile.
- **Maximum profiling range:** The blanking distance, cell size and cell count that defines the profiling range should exceed the maximum water depth in the measurement section. If the profiling range is less than the maximum water depth, the area not measured by the RiverSurveyor can be increased thereby affecting the measurement accuracy.

The criteria summarized in Table 3 serves as a guide for configuration of IC profiling mode.

Table 3. Manual Configuration of IC Profiling Mode

Frequency	Velocity Profiling Range	Blanking Distance	Cell Size Range
1MHz	0.5 – 40m	0.05m	0.2 – 4m
3MHz	0.2 – 5m	0.05m	0.05 – 0.4m

Manual configuration should be used with caution because there are certain restrictions that apply with each frequency and associated blanking distance, cell sizes and cell count. It is highly recommended that a complete measurement is performed using SmartPulse to determine the flow and site conditions at the measurement section. The type of flow conditions that may require the use of manual configuration are described below,

- **Low Backscatter:** In environments with low backscatter conditions such as discharge from springs or under ice measurements lower frequencies tends to give more constant results due to the stronger signal and larger cell sizes.
- **High Sediment:** River systems with high suspended sediment concentration during flood events can limit the range of acoustic Doppler instruments, especially for high frequencies transducers. In this scenario selecting the 1MHz transducers could improve the measurement range
- **Excessive Turbulence:** Excessive turbulent flows increase the noise in the data and selecting large cell size could smooth the data across the profile.

6.12. Recorder

The Recorder Menu is provided on the Systems Tab and provides a way of managing files stored on the 16 GB memory card. You can download all or a selection of files by using the options presented in the Recorder window.

Download all files – downloads all files from the recorder

Download selected files – allows you to select files using the tick box next to the file name. Simply select the files to download and then click on Download selected files.

Format Recorder – Clears the memory of the recorder by erasing all files.

Make sure that there is adequate memory available on the recorder prior to making a discharge measurement. It is suggested to download files and format the recorder between measurement sites. At the very least, all files should be downloaded, and the recorder formatted at the end of the day.

Important: To complete any post processing on the recorded data, the file(s) must be downloaded from the ADP and opened in the *RiverSurveyor Live for PC* software.

6.13. Data Collection

After completing the Pre-measurement tests and initial site-specific entries to configure the System, you can begin the measurement procedure. The software provides a step-by-step procedure outlined below. Each step is explained in detail in the following sections.

Figure 49 displays key concepts for making a discharge measurement

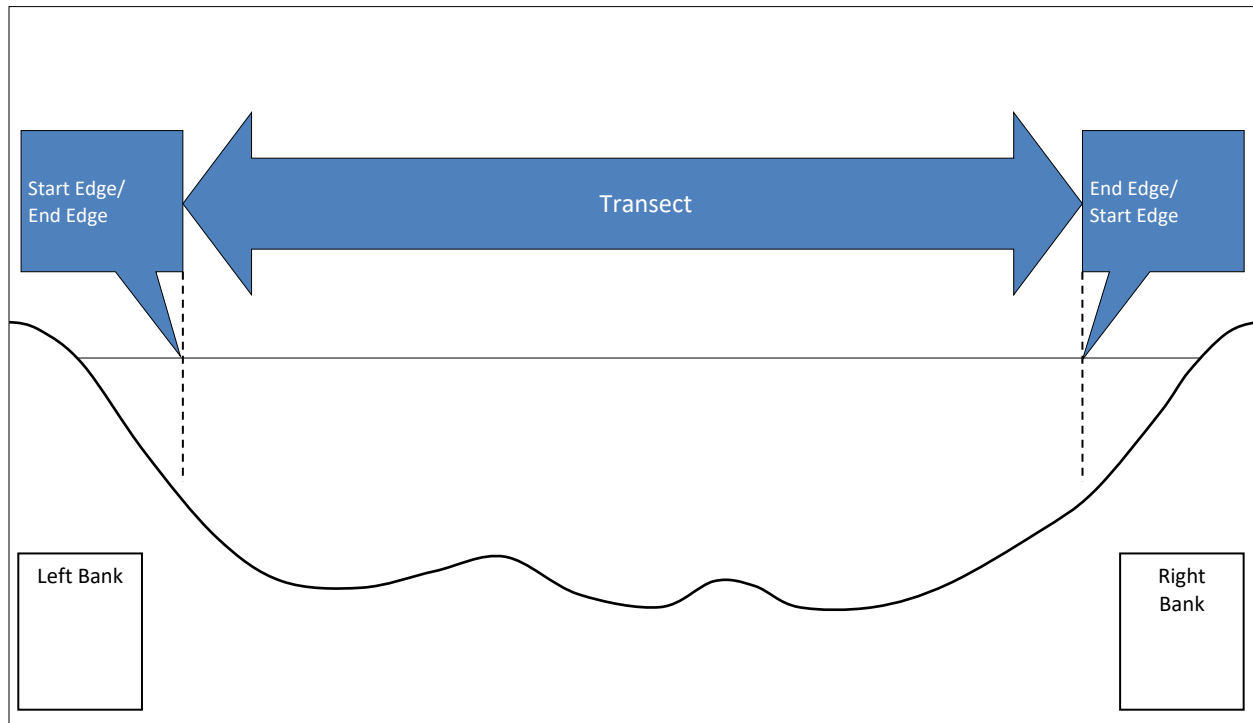

Figure 49. Steps for Making a Discharge Measurement

6.13.1. **Start System**

Click the **Start a Measurement (F5)** button to start data collection. Figure 50 shows where that button is located on the System tab. Note that this does not record any data. Instead it allows the data from the system to be viewed to make sure the system is operating correctly. Make sure that all indicators (shown in the top left) are all valid (not red). Position the vessel at the start edge of the transect.

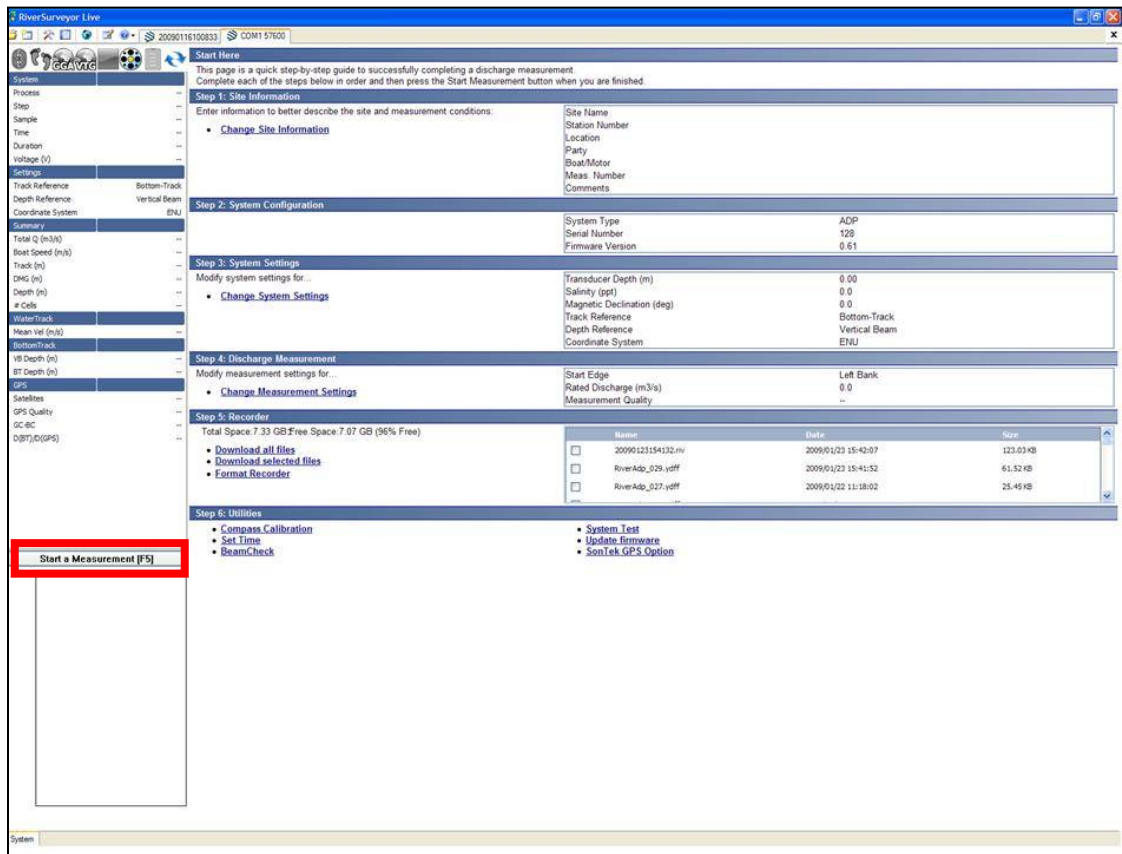

Figure 50. Data Collection – Start a Measurement (F5)

6.13.2. Start Edge

Click the **Start Edge** button (or **F5**) as shown in Figure 51 and collect at least 10 edge samples. The Edge window will be displayed (Figure 52) showing information for both edges. Try to keep the vessel as stationary as possible during this time. Input the start edge information into the Edge dialog that pops up and press OK.

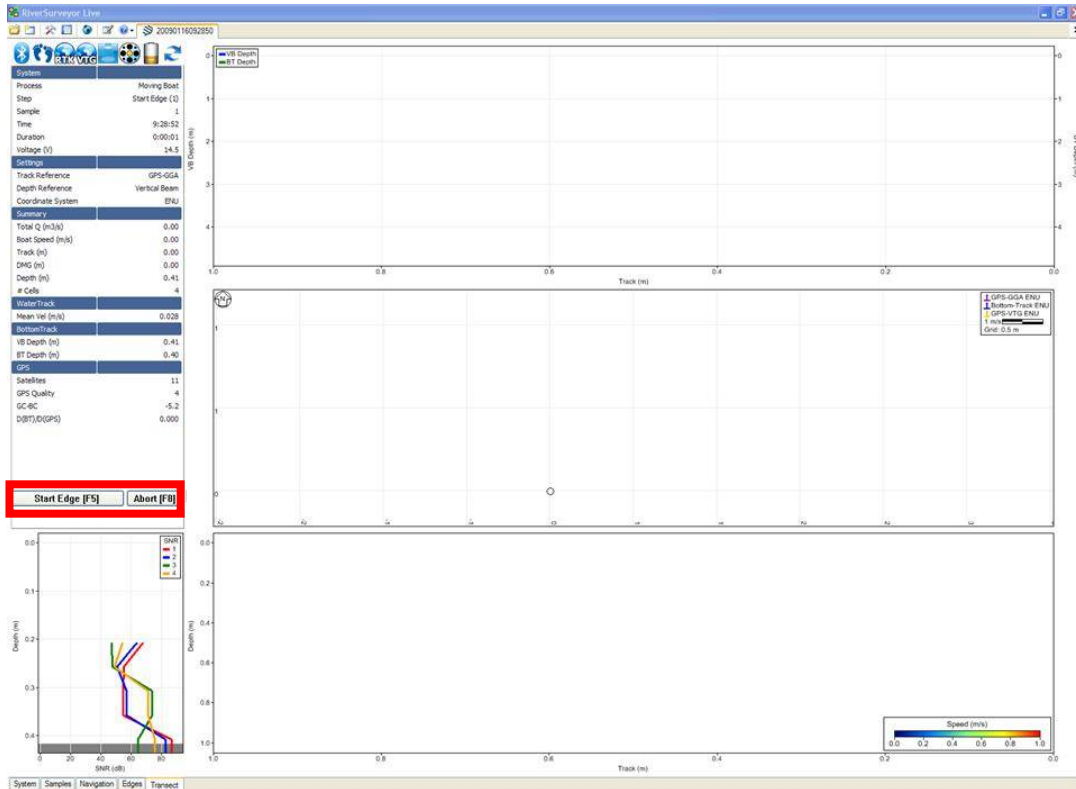

Figure 51. Data Collection – Start Edge (F5)

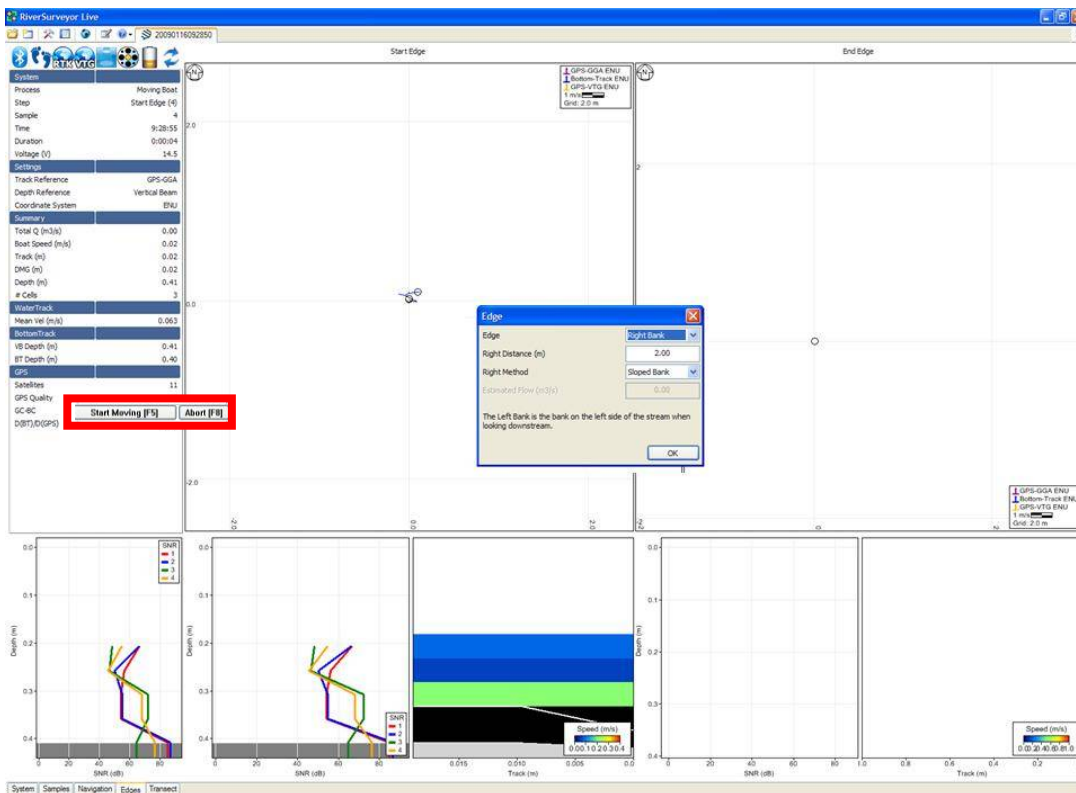

Figure 52. Data Collection – Edge Information

6.13.3. Start Moving

Click the **Start Moving** button (or **F5**) and the Transect window (Figure 53) will be displayed. Try to keep the vessel speed and direction constant as it progresses across the river to the end edge.

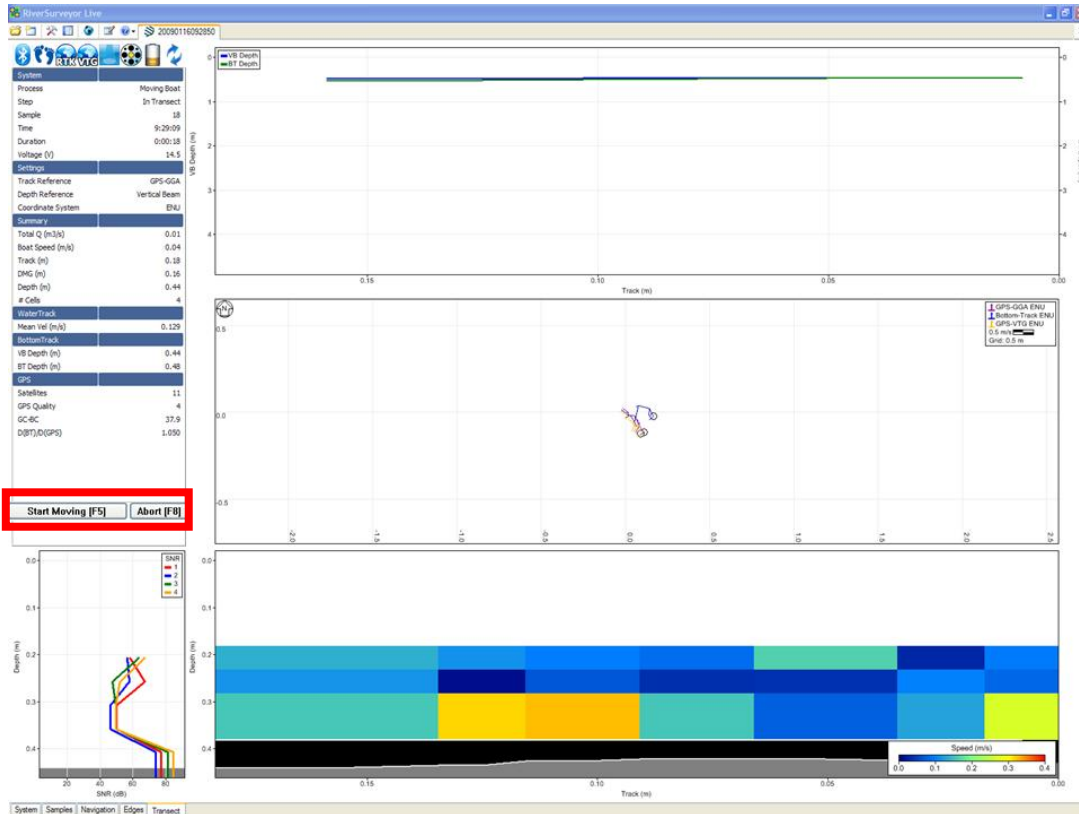

Figure 53. Data Collection – Start Moving

6.13.4. End Edge

Click the **End Edge** button (or **F5**) when the vessel reaches the edge of the opposite bank (Figure 54). A dialog box will prompt you to describe the End Edge (Figure 55). Note that the screen changes from the Transect Tab to the Edges Tab. This allows detailed viewing of the edge data collection. Be sure to collect at least 10 samples at the ending edge. Try to keep the vessel as stationary as possible.

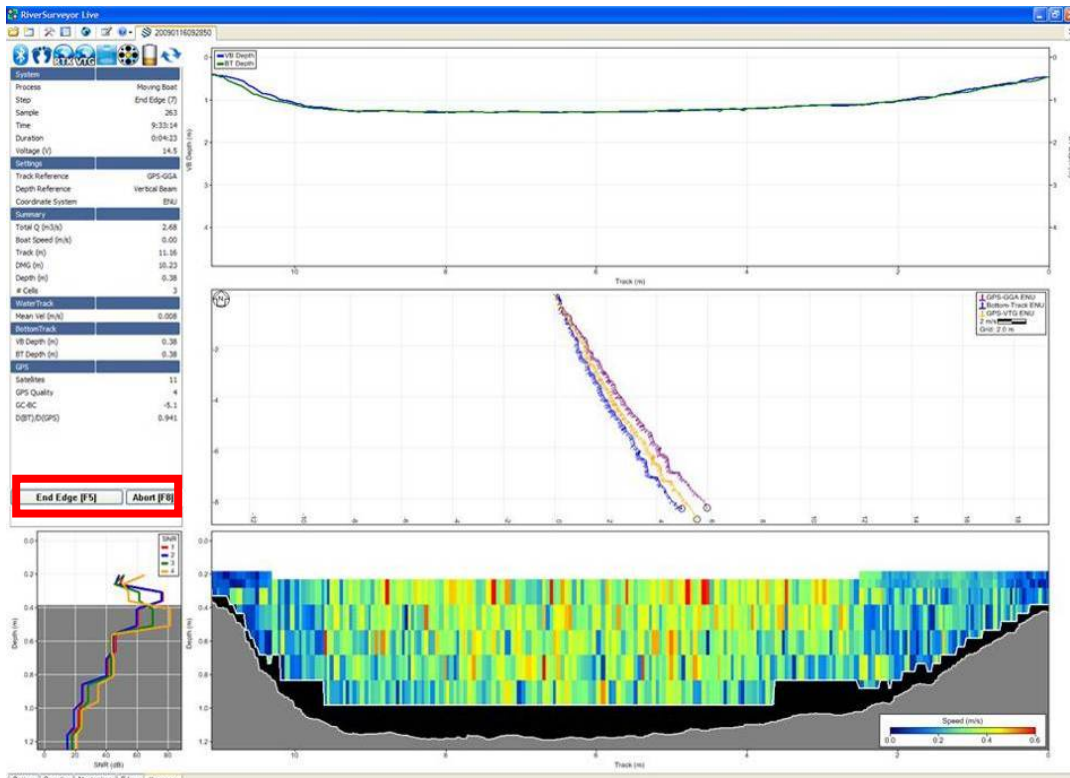

Figure 54. Data Collection – End Edge

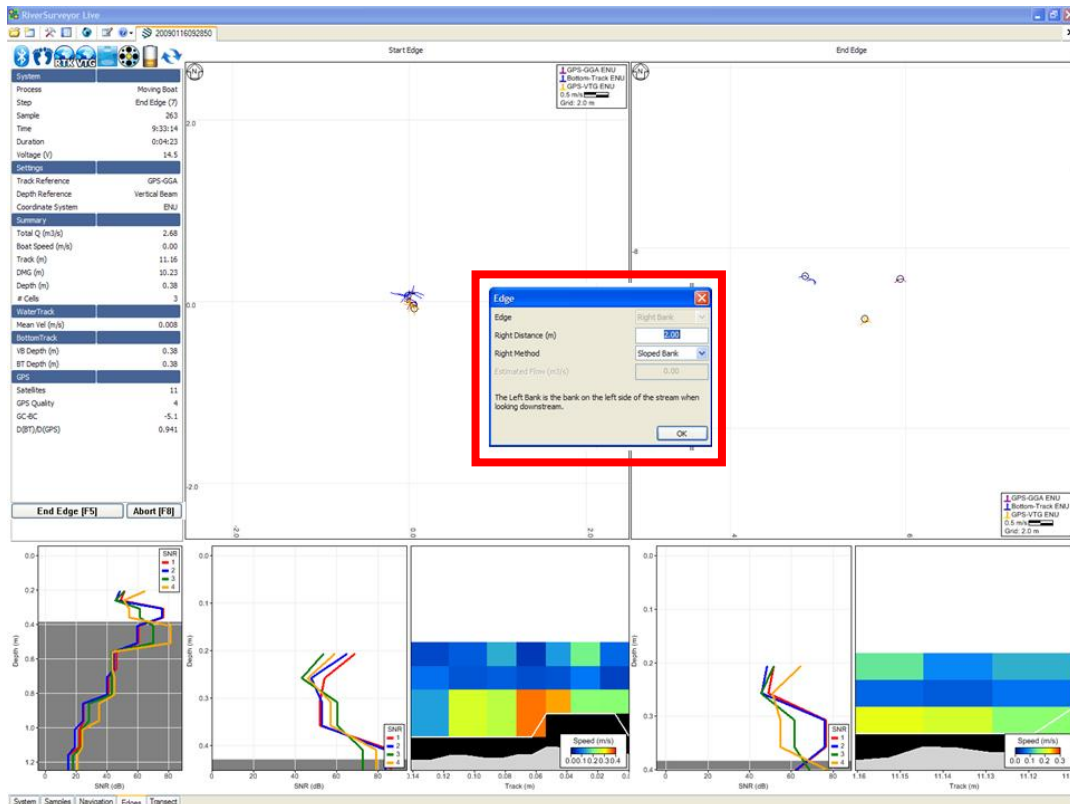

Figure 55. Data Collection - End Edge dialog box

6.13.5. End Transect

Click the **End Transect** (Figure 56) button upon completion of the end edge. This automatically opens a new data collection window so you can start a new measurement. The system is still running, so if you need to make another measurement, click the **Start Edge** button (or **F5**) to begin again as instructed in Section 6.13.2. If data collection is complete, click the **Abort** button or press **F8** to stop. It is recommended to go to the System tab and download the recorded data files upon completion of all the measurements.

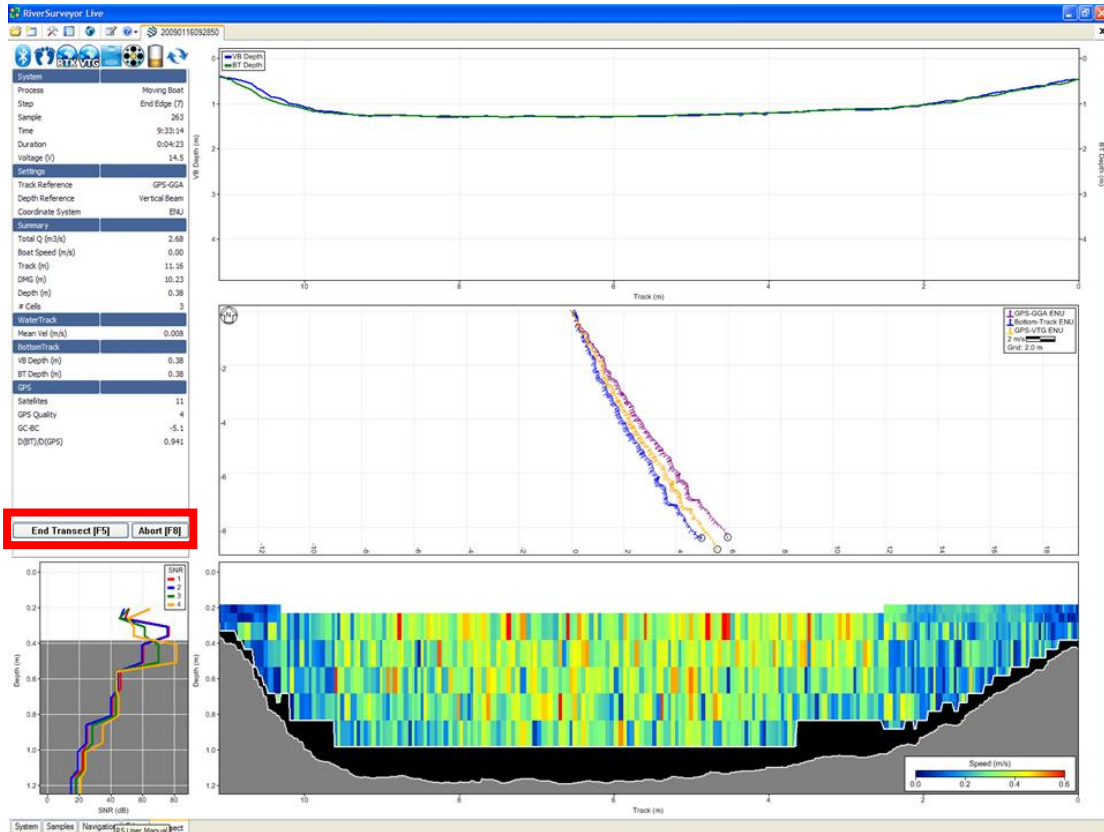

Figure 56. Data Collection - End Transect

6.13.6. Real-Time Quality Control

The Real-Time QC feature was developed to give the users real-time feedback of the data quality and measurement conditions during the measurement. The QC process is applied to every sample measured during individual transects, Loop Method or SMBA Method. The feature allows the user to identify any data quality issues associated with site selection, hydraulic conditions or measurement procedure. A decision can be made in a fraction of time to either repeat the measurement or select another measurement section.

The QC window (Figure 57) is located in the sidebar of RiverSurveyor Live Software and is displayed by default. The user has the option to hide the window by placing the mouse cursor on the sidebar above the QC window and selecting the right button on the mouse. A menu option “Show QC Window” is available at the bottom of the popup menu to either hide or display the window.

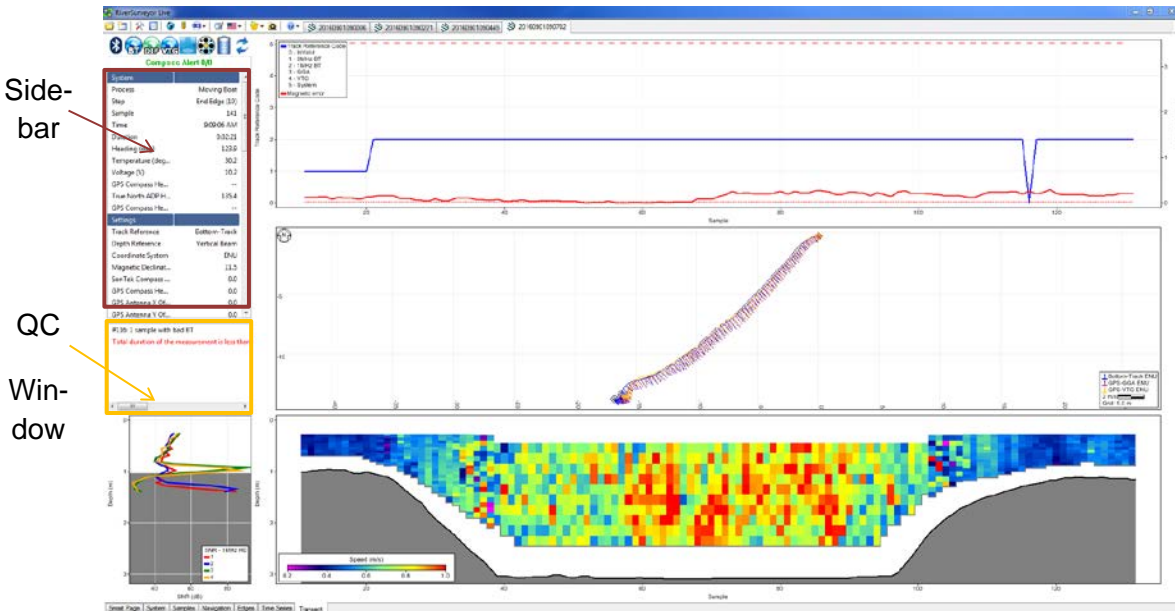

Figure 57. Real-Time QC Window

QC Process

The QC Process is based on international standards and well-developed operational procedures from various organizations. The process is designed around system configuration, measurement components associated with moving boat measurements and system operation.

The message supplied during the measurement process is based on the following structure to inform the user in real-time what aspects of the data collected is affected.

- Warning message in “**Red**” font is based on either an assessment of the measurement or number of samples that can impact the measurement quality.
- Warning message in “**Black**” font is related with an individual sample. The sample number “#8” will be supplied in front of the warning message. Example, “#8 Number of cells is less than 2”.
- Counter message in “**Black**” font supplies the total number of samples related with the specific message.
- Counter / Warning in “**Black**” font message is related with an individual sample. The sample number “#3” and total number of samples related to message will be supplied in front of the warning message. Example, “#3 3 samples with bad BT”.

The variables that are evaluated during the QC Process for each measurement component and associated messages and criteria are summarized in Table 4.

Table 4. Variables and Criteria of QC Process

Measurement Component	Variable	Action	Message	Criteria
System Setup Parameters	Coordinate System	Warning	Beam is selected as coordinate system	
	Track Reference	Warning	System is selected as track reference	
	Transducer Depth	Warning	Transducer depth is 0. Please set in system settings	
	Magnetic Declination	Warning	Magnetic declination is 0. Please set in system settings	
Compass	Pitch/Roll	Warning	Pitch/Roll exceeded calibrated value	
	Magnetic Error	Warning	Magnetic error is greater than 3.5	
Loop Method	Beam Separation	Counter / Warning	Samples with beam separation	
		Warning	9 consecutive samples with beam separation	9 Samples
	Bottom Track	Counter / Warning	Samples with bad BT	
		Warning	9 Consecutive samples with bad BT	9 Samples
	Cells	Warning	Number of cells less than 2	
SMBA Method	Beam Separation	Counter / Warning	Samples with beam separation	
		Warning	9 consecutive samples with beam separation	9 Samples
	Bottom Track	Counter / Warning	Samples with bad BT	
		Warning	9 Consecutive samples with bad BT	9 Samples
	Cells	Warning	Number of cells less than 2	

Measurement Component	Variable	Action	Message	Criteria
Transect	Beam Separation	Counter / Warning	Samples with beam separation	
		Warning	9 consecutive samples with beam separation	9 Samples
	Boat Speed	Warning	Boat Speed is greater than 0.7m/s	0.7m/s
	Bottom Track	Counter / Warning	Samples with bad BT	
		Counter / Warning	Samples with bad BT (edited)	
		Warning	9 Consecutive samples with bad BT	9 Samples
		Warning	Discharge will be biased low	
		Warning	Consider restarting the measurement using GPS reference	
	Cells	Warning	Number of cells less than 2	2 Cells
	Edge	Warning	Too shallow to collect edge data	2 Cells
		Warning	Edge Q is more than 5 percent of total Q	5%
		Warning	Please make sure that the start edge bank is entered correctly	
	Edge (Start)	Warning	Consider moving farther away from bank	2 Cells
		Warning	Number of start edge samples is less than 10	10 Samples
	Edge (End)	Warning	Consider moving farther away from bank	2 Cells
		Warning	Number of start edge samples is less than 10	10 Samples
	Depth Reference	Warning	BT was used as depth reference	
		Warning	VB was used as depth reference	
	Temperature	Warning	Significant change in temperature during transect	2°C

Measurement Component	Variable	Action	Message	Criteria	
	Width	Warning	Variation in width from the previous transect is more than 5 percent	5%	
		Warning	COV of Width is greater than 5 percent	5%	
	Area	Warning	Variation in Area from the previous transect is more than 5 percent	5%	
		Warning	COV of Area is greater than 5 percent	5%	
	Discharge	Warning	Variation in Total Q from the previous transect is more than 5 percent	5%	
		Warning	COV of Total Q is greater than 5 percent	5%	
	Measurement Duration	Warning	Total duration of the measurement is less than 720 seconds. Please consider making 2 more transects		720s
	GPS	GGA	Counter / Warning	Bad GPS-GGA samples. GPS quality is 0 or 1	
			Counter / Warning	Bad GPS-GGA samples. GPS quality changed from 4 to 2	
Warning			HDOP is greater than 2	2	
Warning			Change in altitude from the previous sample is greater than 3 m. Check for Multi-Path	3m	
VTG		Counter / Warning	Bad GPS-VTG samples		
		Counter / Warning	Bad GPS-VTG samples. Boat Speed is less than 0.1 m/s	0.1m/s	
Post Processing	Composite Tracks	Warning	System was used as track reference		
		Warning	BT was used as track reference		
		Warning	GGA was used as track reference		
		Warning	VTG was used as track reference		

Measurement Component	Variable	Action	Message	Criteria
	Depth Reference	Counter / Warning	Samples used substituted depth reference	
	Track Reference	Counter / Warning	Samples used substituted track reference	
System Operation	Battery Voltage	Warning	Replace Batteries	
	Missing Sample	Counter / Warning	Missing Samples	
		Counter	Start Edge	
		Counter	Transect	
		Counter	End Edge	
		Warning	9 consecutive missing samples. Please use corresponding .riv file	9 Samples
		Matlab Export	No automated Matlab export if missing samples are present	

QC Window

Real-Time Display: The QC messages displayed during measurement will be updated with the latest sample at the top of the window. QC messages from previous samples can be accessed during the measurement by using the scroll bar on the right.

Post Processing: The QC messages displayed in post processing will be sorted in sample order, starting at 1st sample. The QC messages can be filtered in the QC menu by selecting the right button on the mouse. Unselect the QC message on the popup window to remove from it from the QC menu.

6.14. Discharge Measurement Summary







By clicking the Discharge Summary icon, you can show or hide the Discharge Summary window at the bottom of the desktop. This window presents the collected data in tabular format and includes the status icons to evaluate the measurement (Figure 58). If desired, resize the window by using the slider arrow when the mouse pointer is positioned over the window border.

File	Left Distance (ft)	Right Distance (ft)	Start Date	Start Time	Duration	Track (ft)	DMG (ft)	Width (ft)	Area (ft ²)	Total Q (cfs)
201408261...	4.60	4.60	8/26/2014	1:17:01 PM	0:03:55	117.59	115.11	124.310	1,506.735	3,074.329
201408261...	4.60	4.60	8/26/2014	1:21:03 PM	0:03:36	116.14	114.83	124.034	1,505.059	3,152.299
201408261...	4.60	4.60	8/26/2014	1:24:48 PM	0:04:39	118.87	115.16	124.360	1,509.619	3,249.753
201408261...	4.60	4.60	8/26/2014	1:29:32 PM	0:03:47	118.45	115.20	124.400	1,514.940	3,419.762
				Mean	0:03:59	117.76	115.08	124.276	1,509.088	3,224.036
				Std Dev	0:00:24	1.05	0.14	0.143	3.752	128.966
				COV	0.000	0.009	0.001	0.001	0.002	0.040

Figure 58. Discharge Measurement Summary

All records are ordered by date/time with icons for starting edge, depth and track reference and coordinate system. All records can be selected or deselected by clicking with the mouse; this affects the statistics presented and is a quick and easy to understand what effect each measurement has on the overall average of the measurements for the site.

Additionally, you can select data to include or exclude from the discharge calculation by simply clicking to activate or deactivate the check box. The Discharge Summary has the following options that can be used in post processing:

-  **Discharge Summary Report:** Generates a printer friendly report that summarizes all data used in the discharge calculation as well as the associated statistics (unchecked records are not displayed).
-  **Export Discharge Summary to ASCII:** Exports the information found in the discharge summary to an ASCII file (.txt).
-  **Delete selected discharge record(s):** Deletes the selected records (the ones with the red check). These records will not be used for the discharge calculation.
-  **Delete all discharge records:** Deletes all records present, essentially removing all transects for discharge calculation

Links between open files and records on the discharge summary are as follows:

- An open file will update its corresponding discharge record with changes to settings or as sample number changes.
- Closing a file leaves the record displayed in the discharge measurement summary, but the record will no longer update
- Deleting the record severs the link to the data file. To add the record back, the file must be reopened.
- Click on a record to switch to the matching data file.
- Delete or uncheck a record to re-compute statistics

6.15. Saving a measurement – SonTek File Compression Utility

 The compress file feature allows the user to create a single file containing all the measurements files, tests, calibrations, data exports and edits performed during post processing. This feature promotes good data management practices and is a valuable tool for users, data auditors and data managers.

Compress Files

The Compress Files feature creates a compressed file with an *.RS extension of all measurement files opened in RiverSurveyor Live (RSL) and the associated files located in the source folder. The default filename created for the compress file is yyyy.mm.dd_hh.mm.ss.RS. The files types that are included in compressed file with the respective criteria are summarized in Table 5.

Table 5. Compress File Types

File Extension	File Type	Format	Source	Action
*.RIVR	Measurement	SonTek	RiverSurveyor Live	Real-Time
*.RIV	Measurement	SonTek	RiverSurveyor	Real-Time
*.txt	System Test	ASCII	RiverSurveyor Live	System Test
*.ccal	Compass Calibration	ASCII	RiverSurveyor Live	Compass Calibration
*.wsp	Workspace File	SonTek	RiverSurveyor Live	Post Processing
*.mat	Matlab	Matlab	RiverSurveyor Live	Export
*.snr	SNR	ASCII	RiverSurveyor Live	Export
*.sum	Summary	ASCII	RiverSurveyor Live	Export
*.vel	Velocity	ASCII	RiverSurveyor Live	Export
*.dis	Discharge Summary	ASCII	RiverSurveyor Live	Export

Data integrity and continuity is the main principle on which the “Compress File” feature is based on and the following aspects need to be taken into account when using the “Compress File” feature.

- Only measurement files opened in RiverSurveyor Live and associated files listed in the Table 5 will be added to the compressed file.
- Compress file feature will only add one “Loop Method” file to the compressed file. Only one Loop Method file can be opened at a time in RiverSurveyor Live.
- Compress file feature will not add a “Loop Method” and “SMBA” files to the same compressed file. Only one method can be opened in RiverSurveyor Live at a time.
- Measurement files that are unchecked in the “Discharge Summary” will also be added to the compressed file.
- Only the files associated with the specific measurements should be in the source folder. There is no verification done on .pdf and .dis files in the source folder. Any file with the .pdf and .dis extension will be added to the compress file,
- File extensions not included in Table 5 will not be added to the compressed file.

Decompress Files

Compressed Files can be opened using the “Decompress Files” feature. RiverSurveyor Live will create a sub-folder in the same location and with the same name as the *.RS compress file located. The sub folder will contain all the measurement files that were opened in RiverSurveyor Live and associated files. The following aspects need to be taken into account when using “Decompress Files” feature,

- A folder “CompassCal” and “SystemTest” is created with in the “Sub-Folder”. The folders contain compass calibration and system test files respectively.

- A warning will be supplied to user that any open transects will be closed before the file is decompressed.
- The “Discharge Summary” will also be cleared of any results from previous transects opened in RiverSurveyor Live.

Section 7. RiverSurveyor Live for Mobile

7.1. Overview—RiverSurveyor Live for Mobile Software

Due to combined portability and ease of use, we recommend the Mobile device for making discharge measurements. The *RiverSurveyor Live for PC* software (described in section 6) can also be used for making discharge measurements and has the added ability to apply powerful data viewing and post-processing capabilities (described in section 8).

Before getting started in the field, remember that the Mobile device has some setup requirements, as does any mobile device/phone: Battery must be installed and charged, necessary software installed, and Bluetooth configured.

Note: M9/S5 systems upgraded with the G3 compass released in 2014 cannot be calibrated with the Motorola Q mobile software.

7.2. Mobile Device Requirements

RiverSurveyor Live for Mobile requires the following:

Operating System: Windows Mobile Smartphone v6.0 or higher

Bluetooth Technology: BroadCom stack and Bluetooth v2.0 with A2DP

Note: The Motorola Q, Q9h, Q9m and Q9c have been tested for full compatibility. Other Mobile devices with these specifications not supplied by SonTek may work, but they are not supported.

7.3. Installation

Prior to installing *RiverSurveyorLive for Mobile* on the Mobile device, please make sure that Microsoft ActiveSync or Mobile Device Center is installed on your desktop or laptop PC. If you do not have ActiveSync or Mobile Device Center installed these can be downloaded from the distribution CD or online at:

<http://www.microsoft.com/en-us/download/details.aspx?id=15> (for WinXP and earlier)

<http://www.microsoft.com/en-us/download/details.aspx?id=14> (for Win7 and Win8)

To install the software follow these steps:

1. Connect the Mobile device to your PC with a USB cable.
2. Copy the RiverSurveyor Live.CAB file from CD-ROM.
3. Open ActiveSync (or Mobile Device Center) on your PC (Figure 59).

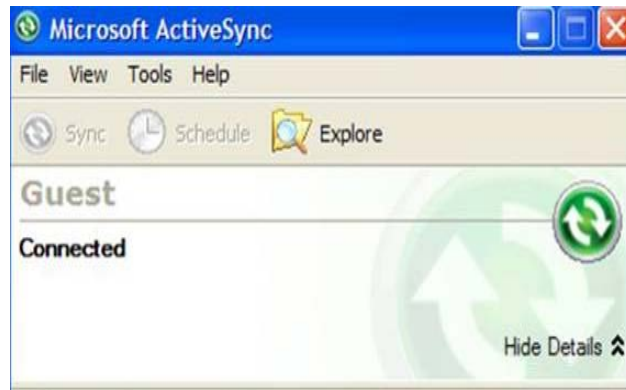

Figure 59. Active Sync Menu

4. Click the Explore button in ActiveSync (My Documents folder on the Mobile).
5. Paste the RiverSurveyor Live.CAB file to the open folder (My Documents) from the Explore window
6. In the Mobile device, use File Manager to open My Documents (Figure 60).

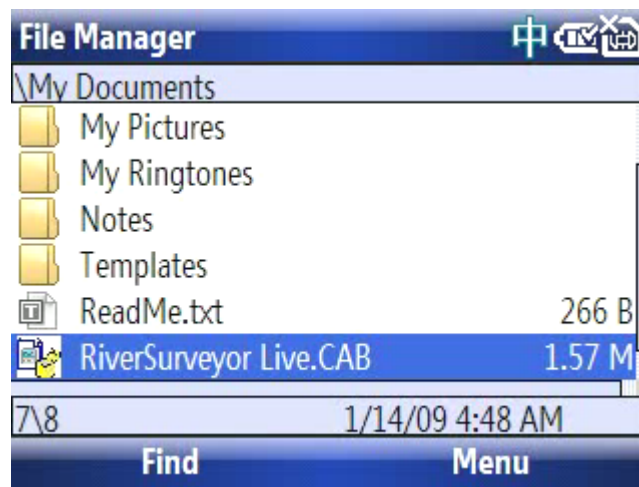

Figure 60. File Manager Menu - My Documents

7. Click the RiverSurveyor Live.CAB file.
8. The RiverSurveyor Live application will automatically install on the Mobile device and automatically confirm the installation of the application (Figure 61).

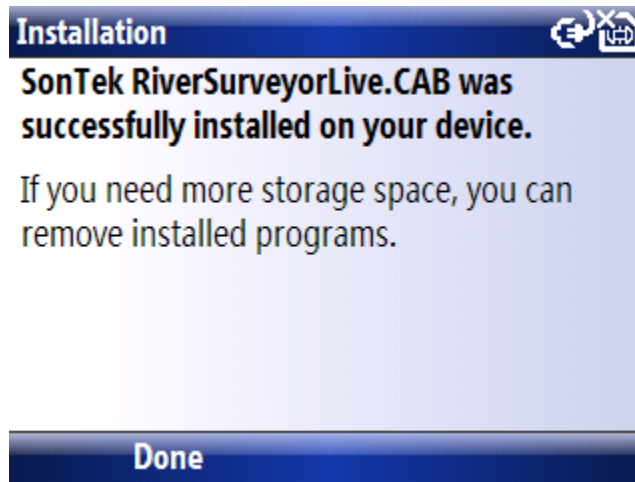

Figure 61. Software Confirmation Window

When the installation is complete, disconnect the Mobile device from the PC and click on the Start button of the Mobile. Verify that the RiverSurveyor icon is displayed in the list of applications (Figure 62). Following the first use of the RiverSurveyor, the icon will be displayed on the shortcut key (Figure 63).

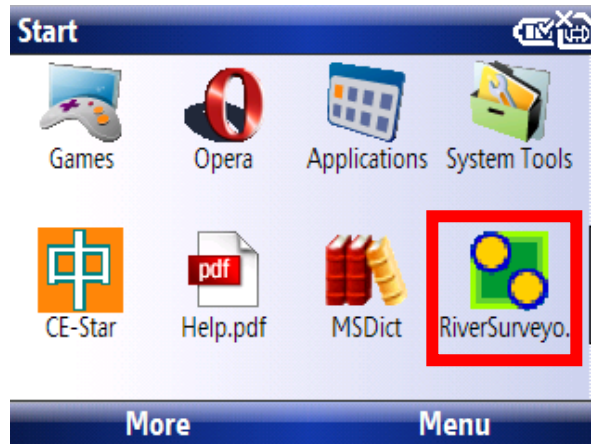

Figure 62. RiverSurveyor Icon in Application List

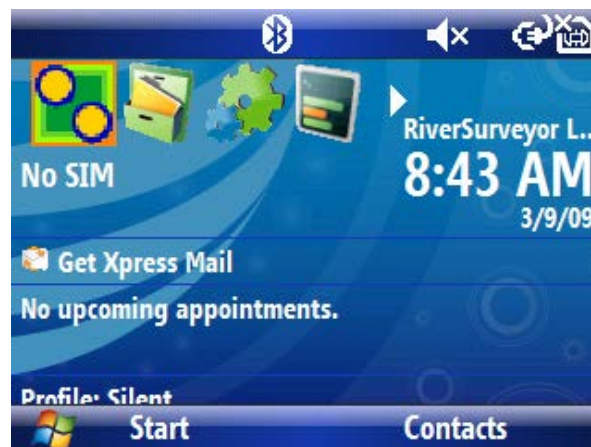

Figure 63. RiverSurveyor Icon on Shortcut List

7.4. Navigation and Controls for Mobile Device

RiverSurveyor Live for Mobile has an intuitive design for navigation and control through its various menus. Text can be entered in various fields using the letter keys on the phone. Navigation from field-to-field in various menus is done using the arrow keys at the top center of the phone. Soft keys can select options, change between screens, and even start and stop data collection. Figure 64 shows an example of the Mobile device with indicators of various functions. Below are a few tips for using the Mobile device:

1. For numerical entry, press the Function key and then the number in edit boxes
2. To lock numerical input (more than one number), press the Function key twice
3. To select or “click” on an item, press the Enter key
4. To view the previous screen, press the Back key
5. To erase all content in a data field, press the Back key
6. To minimize an application, press the End key (minimizing does not close an application)



Figure 64. Mobile Device Functions

7.5. Starting the Software and Connecting to the System

To start *RiverSurveyor Live for Mobile*:

1. Select Start on the bottom left of the Mobile device screen.
2. Use the arrow keys to navigate to the *RiverSurveyor Live for Mobile* application icon  and select it. Or, select the icon from the short cut key.

A Search screen appears (Figure 65) when you start the software. The software will automatically search for any Bluetooth capable *RiverSurveyor* systems within range of the Mobile device (60m). Any *RiverSurveyor* systems within range will be listed on the screen.

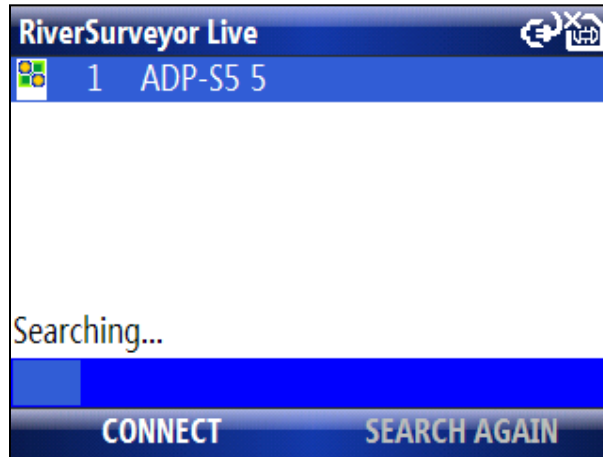

Figure 65. System Search Screen

From the list, select the desired system and press the corresponding soft key to Connect (Figure 66). In the case that only one system is found, the software will connect automatically. In the case that no RiverSurveyor system is found or within range, a “No device found” will be displayed. Make sure that the dummy plug is installed, all system LEDs on the PCM are correct, and the battery is charged and installed correctly. Then, click Search Again.

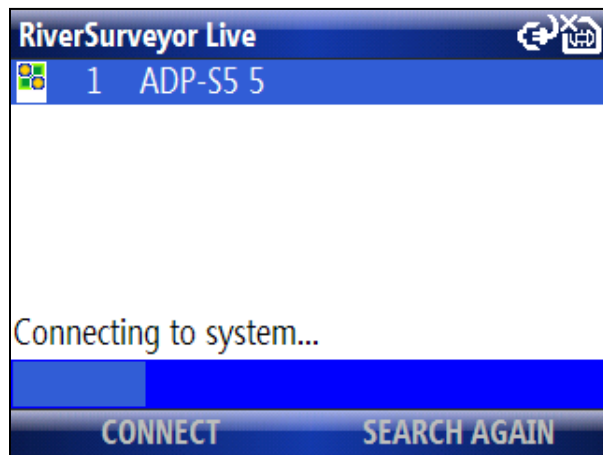

Figure 66. Connection to ADP with Serial Number ADP-S5 5

7.6. Preparing for a Measurement - Main Menu

Once a connection is established, the Main Menu (Figure 67) is displayed and is used to enter site information and initial site parameters. Each of the menu items can be accessed using the control pad or by pressing the corresponding number on the keypad. The START and QUIT options (bottom bar) are selected using the soft keys.

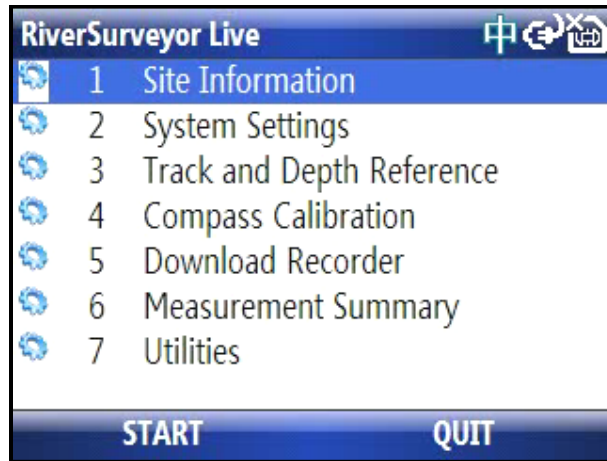

Figure 67. Main Menu

7.6.1. **Site Information (1)**

On the Site Information screen (Figure 68), specific site information such as Site Name, Station Number, Location, Party, Boat/Motor, Measurement Number, and Comments can be entered. To enter data, use the letter keys and the arrow keys to move between fields.

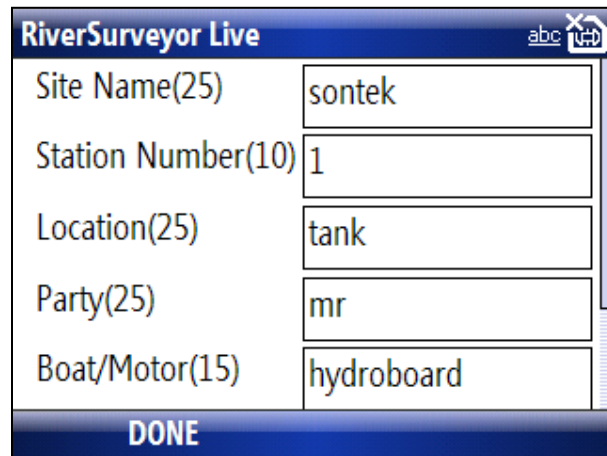

Figure 68. Site Information Screen

The number in parentheses following each field in Figure 68 indicates the number of characters allowed in the field. If this value is exceeded, an error message is displayed. The information entered in this menu is applied to all future measurements, until the system is powered off.

7.6.2. **System Settings (2)**

The System Settings screen (Figure 69) is for entering transducer depth, salinity, and magnetic declination. A description of each field is presented below. After entering System Settings parameters, select DONE to update the values in the system and return to the Main Menu.

RiverSurveyor Live	
Transducer Depth (m)	.06
Salinity (ppt)	0
Magnetic Declination (deg)	12.5
Screening Distance (m)	0.00
DONE	

Figure 69. System Settings Menu

Transducer Depth – This is the distance that the vertical beam transducer is submerged below the surface. Figure 70 shows a basic diagram that depicts an ADP’s transducer face submerged in water. Transducer depth corresponds to the depth of water to which the transducer face is submerged.

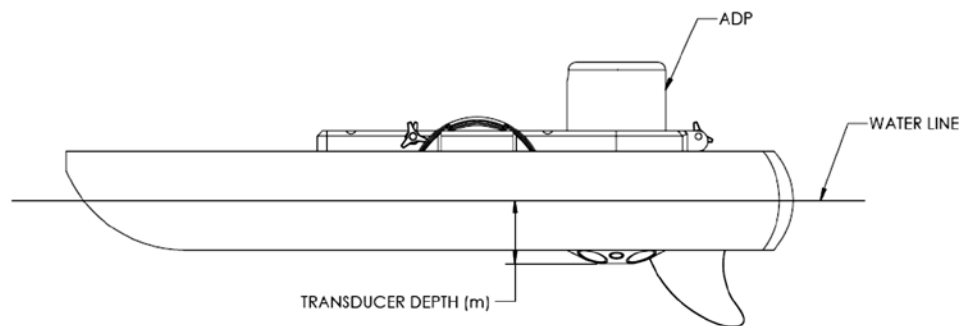

Figure 70. Explanation of Transducer Depth Measurement as shown on the original HydroBoard (similar concept is applicable to all other floating platforms).

Salinity – This user-defined parameter allows for a correction for the speed of sound in water based on the salinity in parts per thousand (ppt) at the face of the ADP. A value representative of the local water conditions must be entered manually to avoid potential erroneous calculations. For reference, the salinity range is between 0 ppt (freshwater) to 45 ppt (seawater). Water temperature is also a factor for speed of sound in water calculations. The ADP has a built-in temperature sensor that automatically compensates for this effect.

Magnetic Declination – On the earth's surface, a calibrated compass indicates magnetic North rather than geographic North. The angular difference between these two directions is called magnetic declination (also known as variation, magnetic variation, or compass variation). Magnetic declination varies across the earth's surface and over time. The ADP compass is shipped pre-calibrated; however, calibration is required at each site to remove any magnetic bias present at the site. Compass calibration will ultimately give better measurement accuracy. The magnetic declination angle (θ) can be found on maps, like the one presented in Figure 71. Magnetic declination maps can be found on many sites on the internet. However, it is important to note that ALL of the magnetic declination values obtained from the internet and/or software are *modeled* values and not actual values measured in the field. As such, variations between the values obtained from websites and/or software may contain small errors. Correcting for such errors can be made with the “Heading Correction” field in the Thresholds menu of the Processing Toolbox.

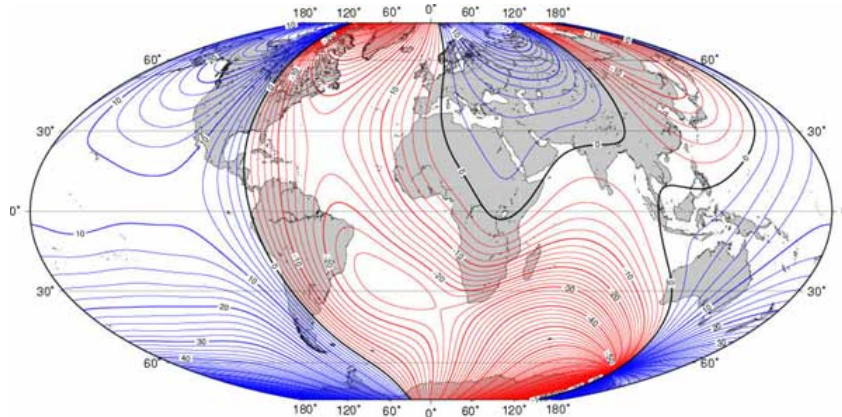

Figure 71. Magnetic Declination Map of the World

Screening Distance – This is the distance below the face of the ADP that you want to start collecting data. In essence, this setting allows you to program the ADP to start collecting data below a certain point. This is primarily used for over-the-boat applications where the screening distance can be set to avoid flow disturbance from the wake of the boat.

7.6.3. *Track and Depth Reference (3)*

The Track and Depth Reference menu (Figure 72) displays options for the track reference, depth reference, and coordinate system. Use the up/down keys to move between fields. To change an option in a field, use the left/right keys. When finished, select DONE (at the bottom) to update the settings and return to the Main Menu.

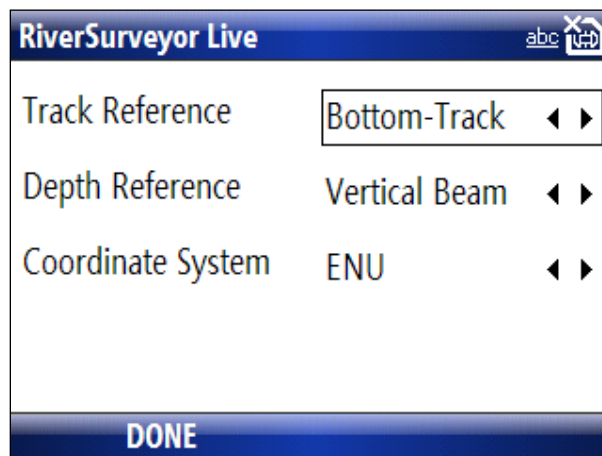

Figure 72. Track and Depth Reference Menu

Track Reference – The ADP measures a water velocity using the Doppler shift principle, using multiple acoustic pulses transmitted and received throughout the water column. When the ADP is in motion, the water velocity measured by the ADP is a combination of boat velocity and water velocity. In order to determine true water velocity, the boat speed must be known and then subtracted from the actual water velocity measurement. The RiverSurveyor “moving boat” discharge application uses three methods (references) to determine boat velocity.

1. **Bottom-Track reference velocity:** The ADP itself can determine boat speed using a technique called “Bottom Tracking”. In this case, bottom-track velocity is calculated using the Doppler shift received from multiple acoustic pulses (transmitted from the ADP) that have reflected off the riverbed. If the riverbed is stationary (i.e. non-moving bottom), then the Doppler shift velocity will consist entirely of boat speed velocity which is acceptable for discharge calculations. If the riverbed is in motion the Doppler-shift-based velocity will consist of both boat speed and riverbed speed which will bias discharge calculations. In this case, the following two references would be preferred to determine boat velocity.
2. **GGA GPS-referenced velocity:** GPVGA (GGA) refers to a specific NMEA-0183 protocol for outputting GPS position data. In this case, the GGA “string” contains actual position (latitude/longitude) information along with several other GPS quality parameters. Boat velocity is calculated by measuring the distance between two successive GGA positions divided by the travel time between those two positions. Differential corrections are required for the GGA data to reduce the amount of position error associated with each measurement. The RiverSurveyor uses two types of differential corrections: “Sub-meter” differential and “Real-Time Kinematic” (RTK).
3. **VTG GPS-referenced velocity:** GPVTG (VTG) refers to a specific NMEA-0183 protocol for outputting GPS velocity data. In this case, the VTG string contains the actual boat speed information along with several other GPS parameters. The GPS velocity is calculated based on the Doppler shift of the received satellite signals.

Select the default track reference for the measurement. All available track references will be available for analysis or to recalculate discharge in post-processing. There are four options:

- **Bottom-Track:** The ADP uses the bottom-track feature to measure the velocity of a vessel relative to the river bottom. The vessel velocity is then subtracted from the measured water velocity to give the absolute water current profile independent of vessel motion. This is the only track reference available for systems without an optional GPS.
- **GPVGA:** The ADP uses the GGA string (from the GPS data) to measure velocity of a vessel based on GPS position data. This is only available for systems configured with a GPS option. It is recommended that GGA data use a sub-meter differential or RTK correction for discharge calculations. The highest quality and most accurate method applies RTK-corrected data.
- **GPVTG:** The ADP uses the VTG string (from the GPS data) to measure the velocity of a vessel based on GPS velocity data. This method requires additional review of data quality parameters to verify data quality.
- **System:** The ADP references all velocities only to itself. This should only be used in specialized applications by experienced users. It is ***not recommended*** for discharge measurements from a moving vessel.

Depth Reference – Select the default depth reference for the measurement. Both options are available for analysis or to recalculate discharge in post-processing. There are two options:

- **Vertical Beam:** This is highly accurate echo sounder data used to determine water depth.
- **Bottom-Track:** This uses data from the four angled beams to determine the depth of the water column using the average depth from each beam.

Coordinate System - Select the default coordinate system for the measurement. All options are available for analysis or to recalculate discharge in post-processing. There are three options:

- **ENU:** This is the traditional East, North, and Up coordinate system.
- **System:** This uses the ADP as a reference. Used for internal testing only.
- **XYZ:** This is a three-dimensional “relative position” coordinate system used only for specialized applications by experienced users.

7.6.4. **Compass Calibration (4)**

A compass calibration is necessary prior to each discharge measurement to compensate for magnetic fields specific to the site. When ready to perform the calibration, click **START**. Rotate the ADP through two complete circles while varying pitch and roll smoothly through the greatest tilt angles possible and practical. It is important to calibrate the compass on the boat or mount and as close to the measurement location as possible. Be sure to remove any mobile phones, PDAs or other metal objects from the area prior to calibration. Figure 73 shows the Compass Calibration menu.

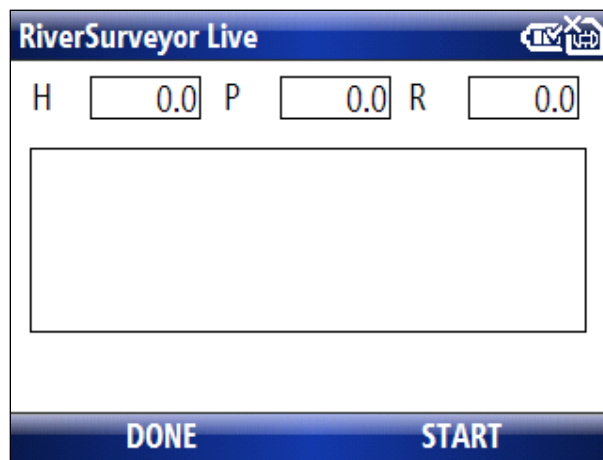

Figure 73. Compass Calibration Menu

At the end of calibration process, select **DONE**, and a calibration score will be displayed as shown in Figure 74, and will be saved to the SD memory card. Using the example below, the calibration score is M6.20Q7. The M “value” should always be less than 10 and the Q “value” should always be very high (based on a scale from 1-10). If the result is anything other than “Pass” the process should be repeated.

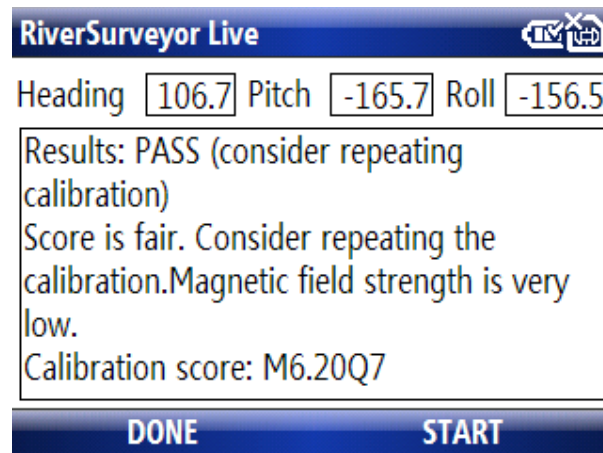

Figure 74. Calibration Score

In the case that the SD memory card is not installed in the Mobile device, you will be notified. The calibration can still be run but will not be saved.

7.6.5. **Download Recorder (5)**

This menu displays the status of the recorder or memory of the ADP. The Download Recorder menu (Figure 75) shows the recorder's Total Space, Free Space, remaining capacity (as a percentage), and recorded file names and sizes. The file names use a four-digit year, two-digit month, day, hour, minute, and second format (YYYYMMDDHHMMSS). All RiverSurveyor Live files have a .riv extension. Within this menu, additional options are available through the MENU soft key. This submenu has the following options.

- **Download All Files:** Downloads all data files into the SD storage card on the Mobile device (if no card, an error is displayed). A folder on the Mobile device is created named SonTek Data. Gauging data is saved in a subfolder name based on the date/time recorded.
- **Download New Files:** Downloads all files which are not already on the storage card.
- **Download Selected Files:** Downloads individually selected files to the SD storage card.
- **Format Recorder:** Erases all data files on the ADP/system recorder.

Transferring files from the Mobile device to PC is easy: Simply insert the SD card from the Mobile device into the PC and access the files as you would a USB drive. Alternatively, connect the Mobile device to the computer via a USB cable to transfer files using Windows Explorer.

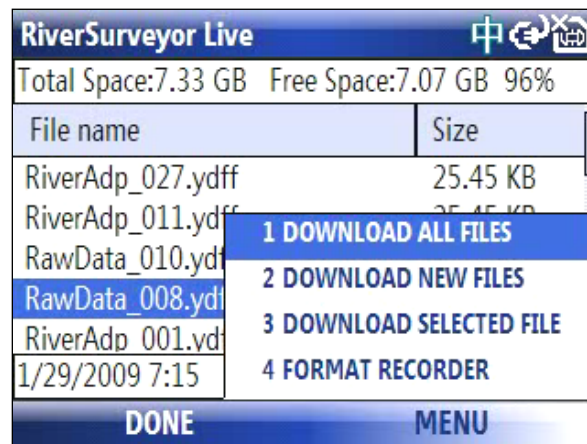

Figure 75. Download Recorder Menu

Make sure that there is adequate memory available on the recorder prior to making a discharge measurement. It is suggested to download files and format the recorder between measurement sites. At the very least, all files should be downloaded, and the recorder formatted at the end of the day.

Important: To complete any post processing on the recorded data, the file(s) must be downloaded from the ADP and opened in the *RiverSurveyor Live* for PC software.

7.6.6. Measurement Summary (6)

The Measurement Summary displays a running list of the discharge measurements you have made, sorted by date/time (Figure 76). The Measurement Summary helps you evaluate data collected in the field. Using the Menu or numeric keys allows for various views of the available data fields. A checkmark next to a measurement indicates that the measurement is used in the statistics provided at the bottom of the window. A red “x” indicates the measurement is excluded from the statistics. Simply use the arrow keys to scroll through the measurements, and the Enter key to select or deselect measurements for the statistics.

	Start Date	Start Time	Track
✓ 1	9/03/2009	8:28:44	0.00
✗ 2	9/03/2009	8:29:02	0.00
✗ 3	9/03/2009	8:29:53	0.00
✓ 4	9/03/2009	8:30:17	0.00

20090309093208 Total Duration=00:01:45
 Mean:0.00 StdDev:0.00 COV:0.000
 DONE MENU

Figure 76. Discharge Measurement Summary

Using the Menu Key, you can display 12 different data fields using 4 different view options. Alternatively, you can press the number keys 1, 2, 3 or 4 to change views (Figure 77).

	Start Date	Start Time	Track
✗ 1	9/03/2009	8:28:44	0.00
✓ 2	9/03/2009	8:29:02	0.00
✓ 3	9/03/2009	8:29:53	0.00
✗ 4	9/03/2009	8:30:17	0.00

200903090930
 Mean:0.00 Std
 DONE MENU

1 OPTION1 1 VIEW
 2 OPTION2 2 DELETEALL
 3 OPTION3 3 DONE
 4 OPTION4

Figure 77. Menu Options in the Measurement Summary

Important Note: Turning off the Mobile device will clear all records from the Measurement Summary on the Mobile device. The full Discharge Measurement Summary is still stored on the ADP system’s internal recorder, however, and can be viewed when the data files are downloaded from the recorder. Also, the **DeleteAll** option deletes all Measurement Summary records from the Mobile device.

7.6.7. Utilities (7)

The Utilities Menu (Figure 78) provides several options explained below. The System Test (option 3) is recommended prior to data collection. Select DONE to exit the Utilities Menu.

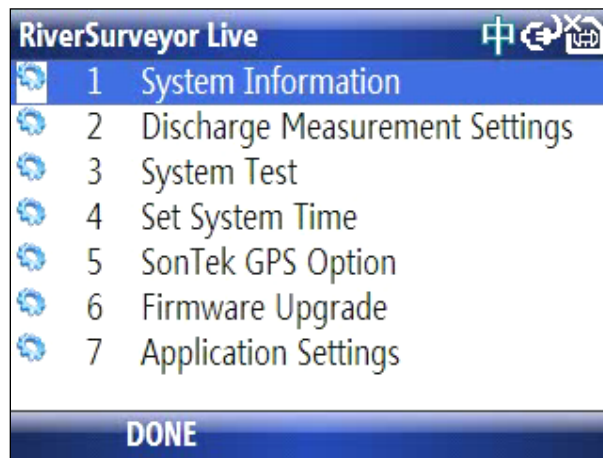

Figure 78. Utilities Menu

System Information (Figure 79): Shows system type, serial number and firmware version.

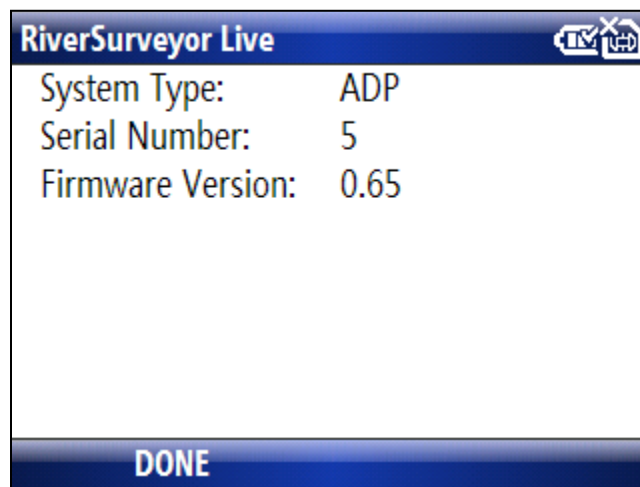

Figure 79. Utilities – System Information

Discharge Measurement Settings (Figure 80): Information that is applied to the discharge measurement.

- **Start Edge** – Sets the default starting edge for discharge measurements (right or left bank).
- **Rated Discharge** – Enter a rated discharge pre- or post-measurement. This information is useful for post-processing data analysis and evaluation.
- **Measurement Quality** – A post-processing qualitative input to evaluate the discharge measurement quality.

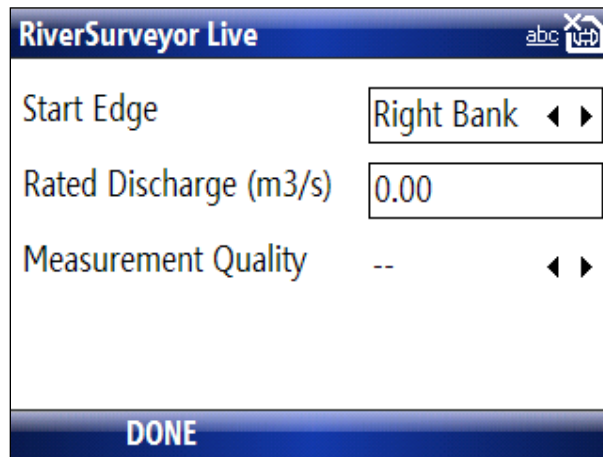

Figure 80. Utilities – Discharge Measurement Settings

System Test (Figure 81): Runs a diagnostic test confirming the status of the battery, temperature sensor, internal 16 GB recorder, and compass. When finished, the system reports the test results and saves them to a file in the SonTek Data folder of the SD card of the Mobile device. You will be notified of either a System Test PASS or FAIL result.

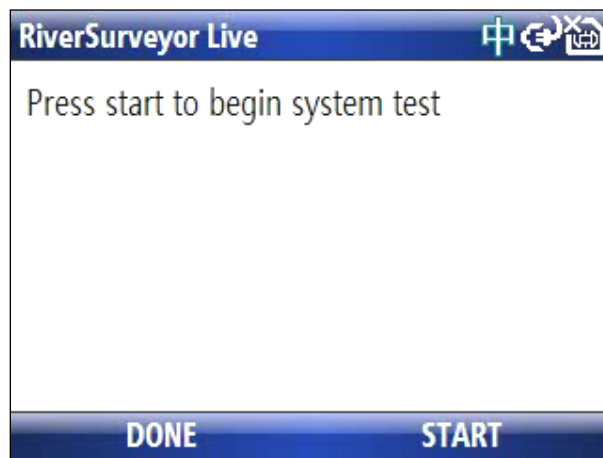

Figure 81. Utilities – System Test

There are four possible System Test failure messages (provided below), all of which require user action prior to making valid discharge measurements.

- System battery voltage > 12 volts
- System compass is not working
- System SD card is not working
- Temperature sensor is not working

Set System Time (Figure 82): Used to set system time to the Mobile device time or to a manual entry. Typically, this is a pre-processing setting that can be used as a default for all measurements. Use the up/down keys to navigate between fields and the number keys to enter data. Select SET TIME to update the system time and DONE to return to the Utilities Menu.

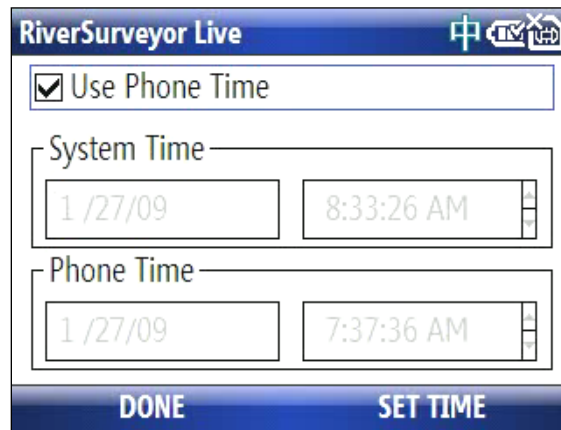

Figure 82. Utilities – Set System Time

SonTek GPS Option: Confirms the current SonTek GPS application and provides the option to change to a different application (Figure 83). For RTK GPS applications, you can change from RTK quality GPS to Differential quality GPS and vice versa. However, systems with only Differential quality GPS cannot change to RTK quality GPS based on hardware constraints. There is no capability of integrating a shore-station differential GPS correction.

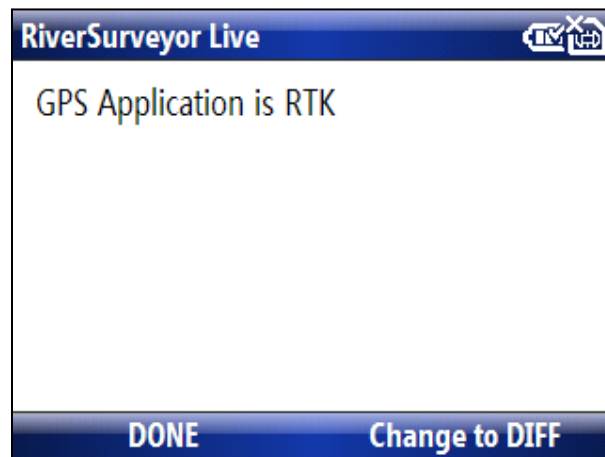

Figure 83. Utilities - SonTek GPS Option

Firmware Upgrade (Figure 84): This menu lets you update ADP firmware by selecting a firmware file (*.a79) stored in the phone's memory card (SD) or internal memory. Select UPGRADE and follow the on-screen instructions to install new firmware.

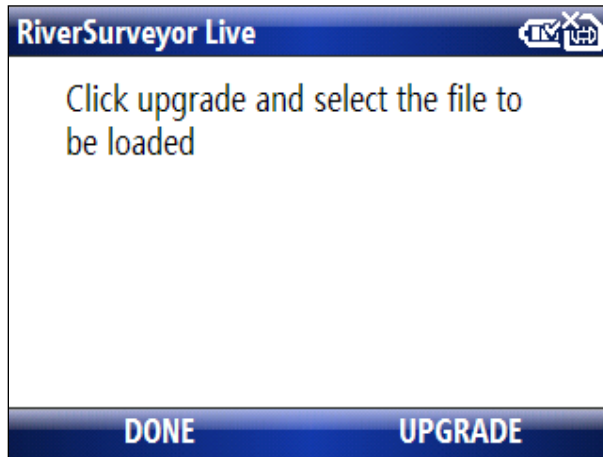

Figure 84. Utilities – Firmware Upgrade

Figure 85 shows the Find File screen that displays a menu for finding the firmware upgrade file. If a file is not selected, an error message is displayed. You can navigate with the up/down keys and select with the enter key. Additional options are available via the MENU option. Select Open to upload the firmware file.

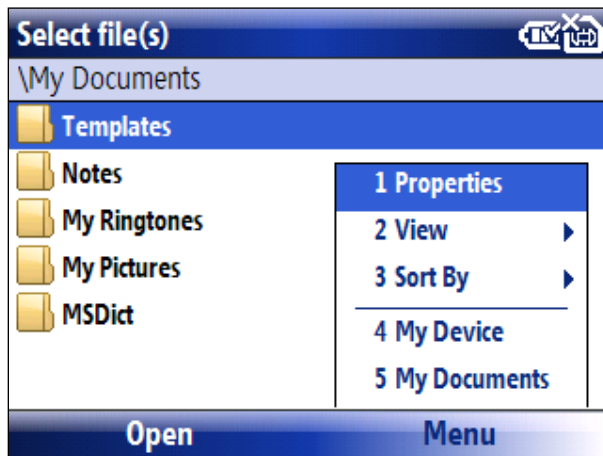

Figure 85. Utilities – Firmware Upgrade Find File Screen

Application Settings (Figure 86): Activating the check-box for Bluetooth: Connect Automatically enables the software to connect to the first system detected. This menu is also used to apply either Metric or English units. Typically, these options are applied as default settings. Select DONE to update these settings and return to the Utilities Menu. In the bottom right of the window, the version of the software is indicated.

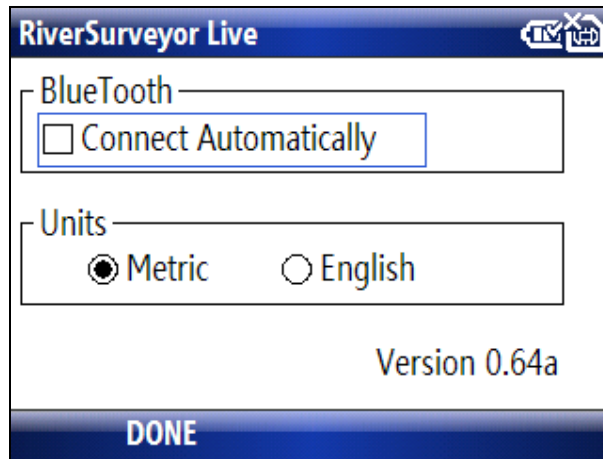

Figure 86. Utilities - Application Settings

7.7. Discharge Measurement - Data Collection

Below is a detailed procedure for conducting a discharge measurement. In general, the process has five steps which include the following:

1. Start a Measurement
2. Start Edge
3. Start Moving/Transect
4. End Edge
5. End Transect

Once a measurement is started, the software prompts you at each step, allowing you to focus on the measurement.

7.7.1. Starting the measurement

To start data collection using the moving boat method, select START from the Main Menu view (Figure 87). The system starts “pinging” and collecting data profiles.

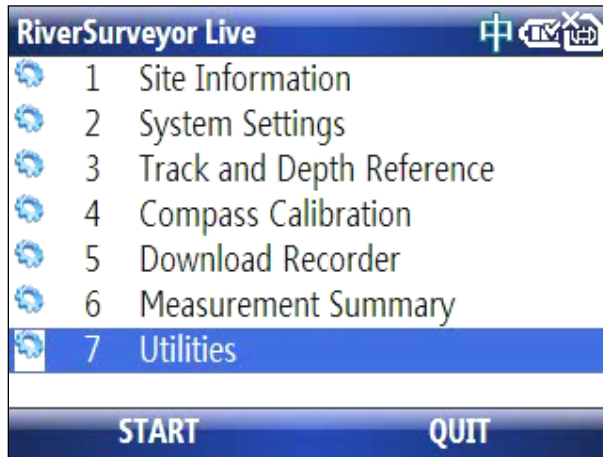

Figure 87. Main Menu – Start Data Collection

Appendix A provides a description and list of icons used on the software’s status bar. Note that icons are color coded – typically moving from the color blue (indicating optimal status) to red (indicating nonfunctional). Gray indicates the option is not installed.

7.7.2. Start Edge

By pressing the soft key corresponding to **Start Edge** (Figure 88) you are prompted to enter Starting Edge (Left or Right bank), Method (slope bank, vertical bank, user input), and Distance (i.e., distance from Starting edge) as displayed in Figure 89. After entering the edge information, select **OK** to view start-edge samples. In order to collect precise and accurate information, make sure the boat is as motionless as possible

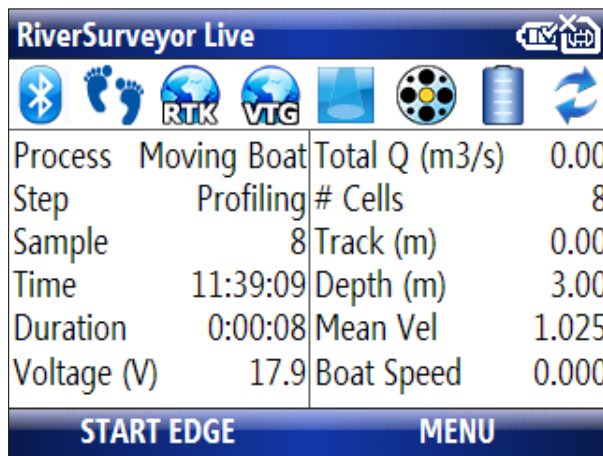

Figure 88. Data collection - Start Edge

Figure 89. Data Collection - Start Edge Inputs

Figure 90 shows the RiverSurveyor collecting data after entering START EDGE inputs. Collect at least 10 profiles/samples edge and select **START MOVING** to go to the next step. At this point, it is important to make sure the system is running and collecting samples. It is also important to confirm the status icons are valid (see Appendix A).

Process	Moving Boat	Total Q (m3/s)	0.00
Step	Start Edge (16)	# Cells	8
Sample	16	Track (m)	0.00
Time	11:39:37	Depth (m)	3.00
Duration	0:00:16	Mean Vel	1.025
Voltage (V)	17.9	Boat Speed	0.000

Figure 90. Data Screen After Start Edge

7.7.3. *Start Moving*

Before moving the vessel across the transect, press **Start Moving**. Now start moving the system smoothly and slowly across the channel. Figure 91 displays the Start Moving screen.

RiverSurveyor Live			
Process Moving Boat		Total Q (m3/s)	0.00
Step	Start Edge (16)	# Cells	8
Sample	16	Track (m)	0.00
Time	11:39:37	Depth (m)	3.00
Duration	0:00:16	Mean Vel	1.025
Voltage (V)	17.9	Boat Speed	0.000
START MOVING		MENU	

Figure 91. Data collection - Start Moving

This window shows the data as it's being collected across the channel. Additional views are available to display the other data parameters being collected. Press the Menu key to select the data display to view. The number keys 1, 2, 3 or 4 can also be used to change the views, as shown in Figure 92.

RiverSurveyor Live 20090309113923			
Boat/Water	1.3	Satellites	10
DMG (m)	65.04	GPS Quality	4
Temperature	23.9	D(BT)/D(GPS)	1.000
Heading (deg)		VIEW	0.0
Pitch (deg)		ABORT	0.0
Roll (deg)		DISCONNECT	0.9
END E	1 Main	MENU	
	2 Sensor+GPS		
	3 Discharge		
	4 Settings		

Figure 92. Data Collection – Start Moving Data View

7.7.4. **End Edge**

After arriving at the opposite bank, select **END EDGE** (Figure 93). You are then prompted (Figure 94) to enter Method (Vertical Bank, Sloped Bank, User Input) and Distance (i.e., distance from ending edge). If you set Method to User Input, use the User Flow field to enter an estimate of flow for this area starting from the ending edge. Select **OK** to go to the END TRANSECT menu. Be sure the vessel stays as motionless as possible to collect the best edge data. Collect at least 10 samples/profiles before going to the End Transect step.

RiverSurveyor Live 20090309113923			
Process	Moving Boat	Total Q (m3/s)	8.88
Step	In Transect	# Cells	8
Sample	29	Track (m)	3.00
Time	11:39:50	Depth (m)	3.00
Duration	0:00:29	Mean Vel	0.773
Voltage (V)	17.9	Boat Speed	1.001
END EDGE		MENU	

Figure 93. Data collection - End Edge

RiverSurveyor Live	
End Edge	Right Bank ◀ ▶
Method	Sloped Bank ◀ ▶
Distance(m)	<input type="text" value="2.00"/>
User Flow(cms)	<input type="text" value="0.00"/>
The Left Bank is the bank on the left side of the stream when looking downstream.	
OK	

Figure 94. Data collection - End Edge information

7.7.5. End Transect

Figure 95 shows the End Transect screen. Press the End Transect button to complete the measurement.

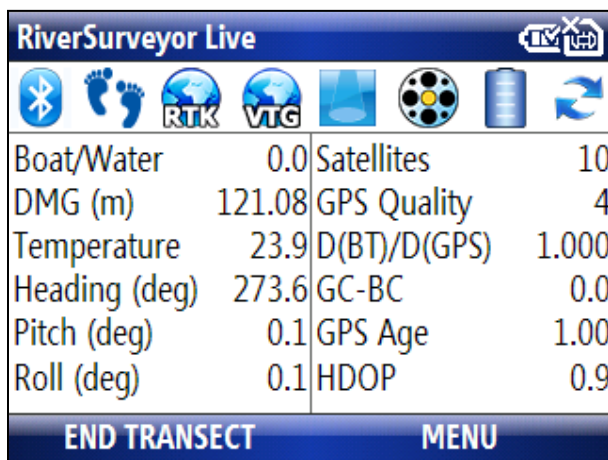

Figure 95. End Transect Screen

After the transect ends, the Measurement Summary screen appears (Figure 96). It shows data from each transect as well as statistical calculations. Arrow keys allow movement from cell to cell. Using the Select key in the left column includes/excludes transects, which changes the statistics. This lets you discard invalid transects, making the final discharge calculation available in the field.

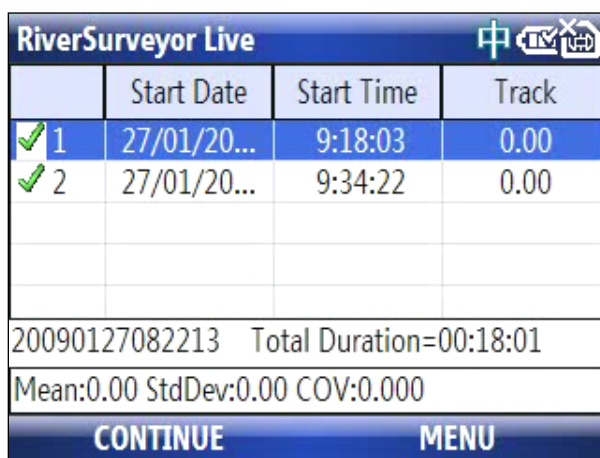

Figure 96. Discharge Measurement Summary Screen

Select CONTINUE to make another measurement, or MENU and DONE to go to Main Menu. At any step in the moving boat process, you select MENU and then ABORT to cancel the measurement and go back to main menu. Also, at any step, you can select MENU and then DISCONNECT to disconnect the Mobile device from the system, but leave the system still running. You can reconnect to the ADP with the same or different Mobile device, or with a PC, all while the system continues to collect data without losing any information. Figure 97 displays the Abort and Disconnect options.

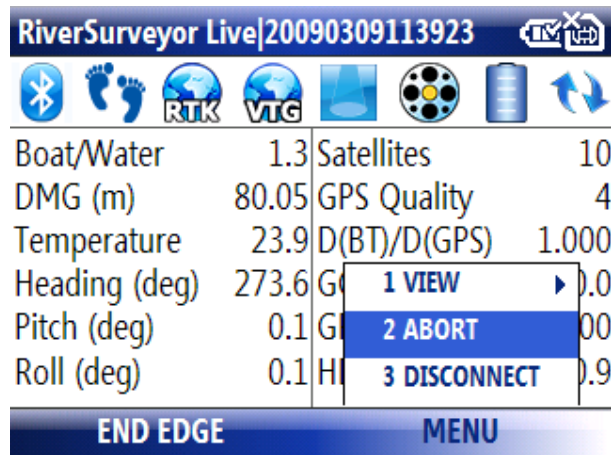

Figure 97. Data Collection - Abort and Disconnect Options

7.7.6. **Data collection - Swapping between Mobile Device and PC**

The *RiverSurveyor Live* software allows you to swap between measurement devices (Mobile device and PC) while the system is collecting data. Data collected by the RiverSurveyor system (ADP) is stored inside the ADP, so there is no risk of losing data when swapping between devices. More importantly, the data will not be lost if communications to the ADP is interrupted for any reason.

To swap from the Mobile device to a PC, disconnect from the system during data collection.

This is done by pressing the Menu button and then Disconnect as displayed in Figure 97.

Simply connect to the system with a PC or other Mobile device to continue with the measurement.

7.7.7. **Transferring Data from Mobile Device to PC**

Transferring data files from the Mobile device to the PC is done by simply connecting the Mobile device to the PC via a USB cable. Make sure that ActiveSync or Windows Mobile Device Center is installed on the PC so the Mobile device and PC can communicate. After the Mobile device is powered on and connected to the PC, ActiveSync (or Windows Mobile Device Center) will recognize the Mobile device and display it as a Mobile device on the PC in Windows Explorer.

You can then go to the appropriate folder that contains the collected data (data files have a .riv extension) and download (Save, Copy and Paste, or Cut and Paste) the files to the desired folder on the PC. The PC folder is where you will access the data for viewing, post-processing, and analysis using the *RiverSurveyor Live for PC* software. Figure 98 shows the Main Menu window for *RiverSurveyor Live for PC*. In the section titled Data Files (highlighted in red), files can be selected manually, or they can be opened using hot links to the most recently used files.

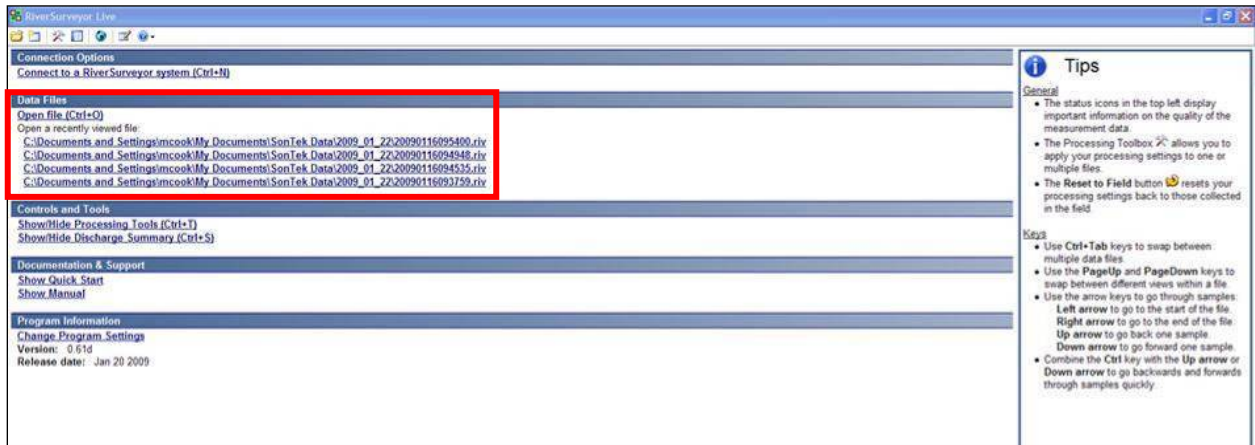

Figure 98. Main Menu for *RiverSurveyor Live for PC*

Section 8. Reviewing Data Files/Post-Processing

8.1. Overview

This section is to be used as a guide to open, view and post-process data files using the *RiverSurveyor Live for PC* software. An initial explanation will describe the layout of the data and the various tabular views. A detailed description of the post-processing options will follow.

8.2. Opening Data Files

To open and process data in *RiverSurveyor Live for PC*, all data files must have the .riv or .rivr file extension. Figure 99 shows three ways to open data files. Click the open file icon (the folder) on the top toolbar to browse for and select a file. Alternatively, you can click on the **Open file (Ctrl+O)** link or one of the most recently viewed files.

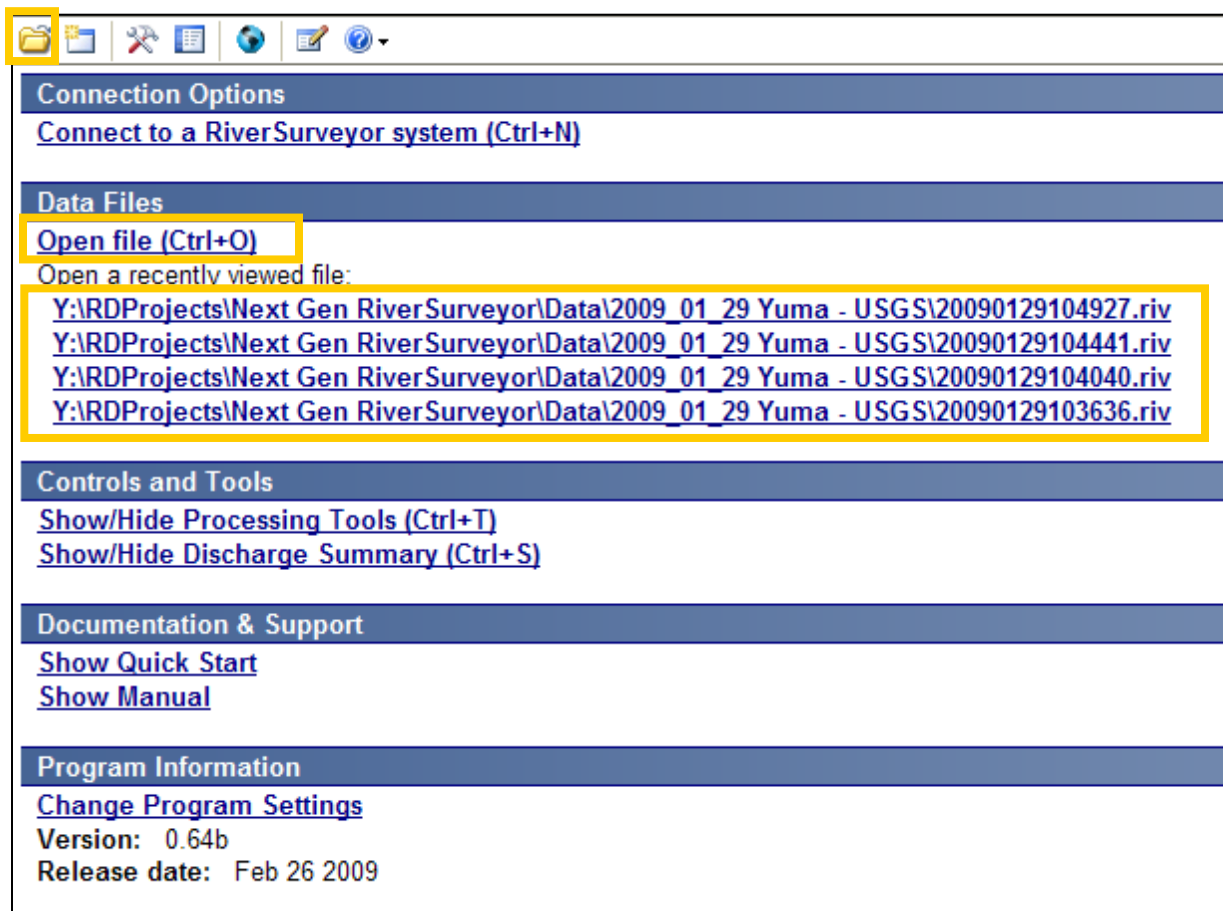

Figure 99. Open Data Files in RiverSurveyor Live for PC

8.3. Application Layout

The application layout is divided into seven sections, shown below in Figure 100.

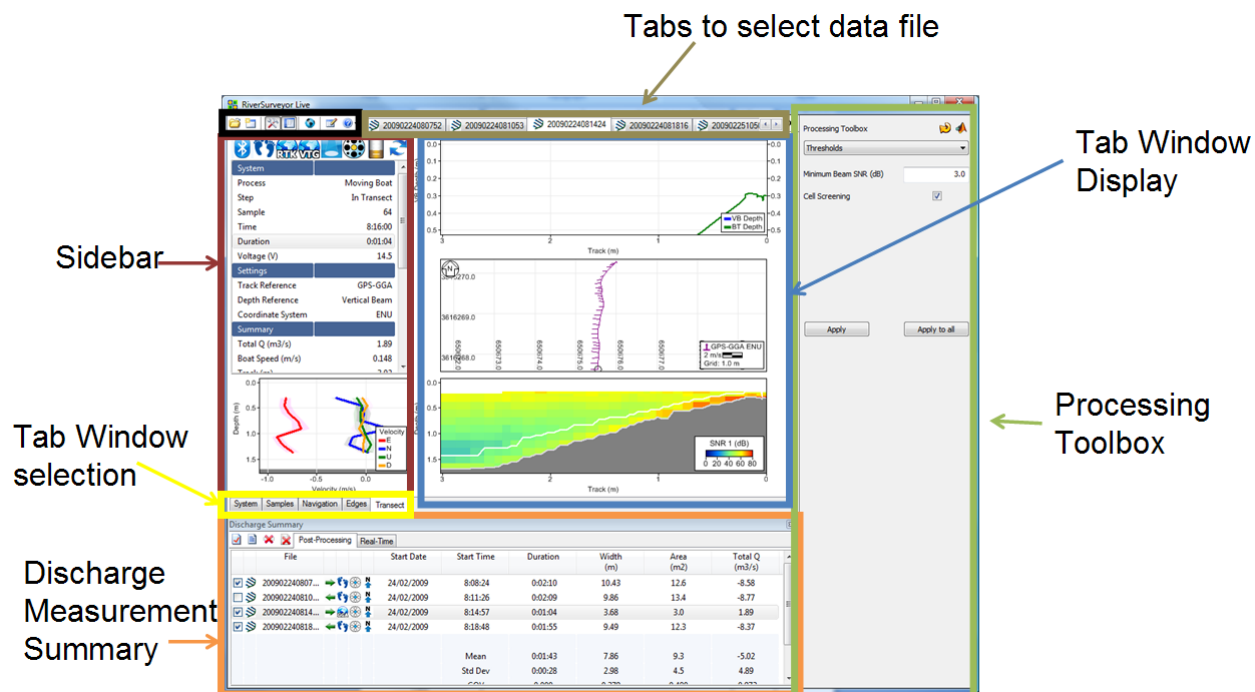

Figure 100. Application Layout for PC Software

8.3.1. Main Toolbar Icons

The Main Toolbar at the top of the screen provides quick links to open files, connect to an ADP and change the program views and settings. Below is an explanation of each:



Open File (Ctrl + O) – Opens a window to select files for viewing and post-processing.



Connect (Ctrl + N) – Allows the selection of communications types with the RiverSurveyor: for a direct connect option or a SS radio connection select a Com Port, while Bluetooth users should click on the tick-box at the bottom of the window.



Show/Hide Processing Toolbox (Ctrl + T) – Toggle button shows or hides the Processing Toolbox for post-processing analysis.



Show/Hide Discharge Summary (Ctrl + S) – Toggle button shows or hides the Discharge Summary for post-processing analysis.



Load GIS Shape File – Opens a window and to load pre-saved geo-referenced Shape File that can be used as a background for the data collected. This is a useful visualization tool for user in post-processing. See Section 8.3.10.



Change Program Settings – Opens a window to select:

Unit System (English or Metric)

Automatic Matlab Export: This is disabled if the file has any missing samples.

Enable Serial Faster Baud Rate: This allows the user to connect to the RiverSurveyor at either the highest baud rate available or at 56700. This feature can resolve communication issues experienced with long communication cables or drivers affecting Bluetooth or Spread Spectrum Radio operations.

Lat/Long Unit System: This allows the user to select between Decimal Degrees and Decimal Minutes.

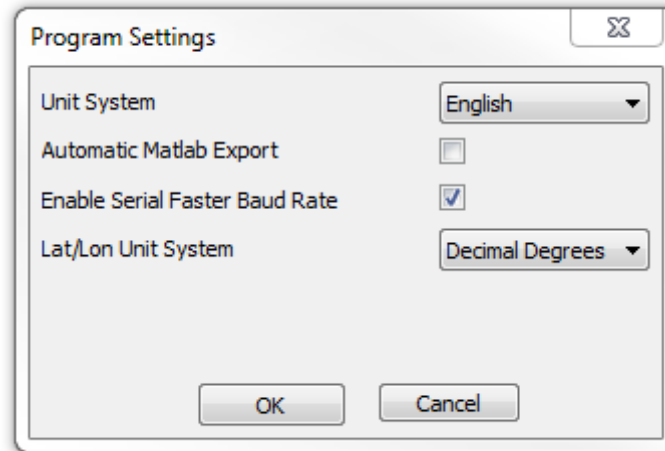

Figure 101. Program Settings



View Documentation – Presents help documents.

8.3.2. **Data file Tabs**

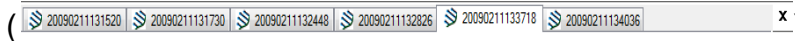

Figure 100 highlights the location of the Data file tabs. Each tab is an open file with the year, month, day, hour, minute, second format (i.e. YYYYMMDDHHMMSS). The tabs are used to toggle between open data files. Multiple files can be opened simultaneously. Users can swap between tabs by clicking or using Ctrl+Tab or Ctrl+Shift+Tab. To close tabs, click the X or use the Ctrl+F4 hot key.

8.3.3. **Sidebar**

The Sidebar displays the status icons as well as customizable tabular data and a profile graph for the current sample. Status icons are explained in Appendix A. Right-click on the tabular data to select the display options shown in Figure 102. In addition to the various data display options, there is an “Add all” option to include all data fields or a “Reset to default” option to apply the standard view.

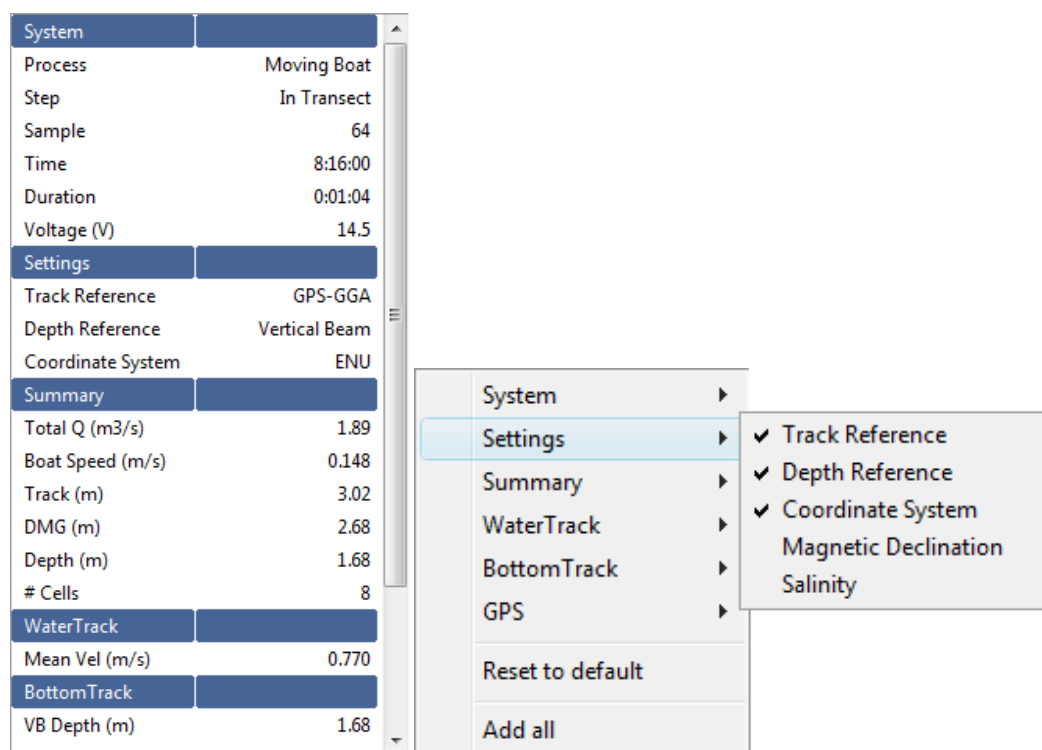

Figure 102. Sidebar Tabular Data with Right Clicking Menu Options.

The graph portion of the Sidebar displays the vertical profile through the water column. Double-click on the axes to change the scale. Right-click on the graph to display a pop-up menu that allows for further customization of the graph. Below is an example for viewing the velocity profile.

After right clicking on the graph, select WaterTrack and then Velocity. This will display each velocity component along with the Standard Deviation as a shaded band around each line (Figure 103).

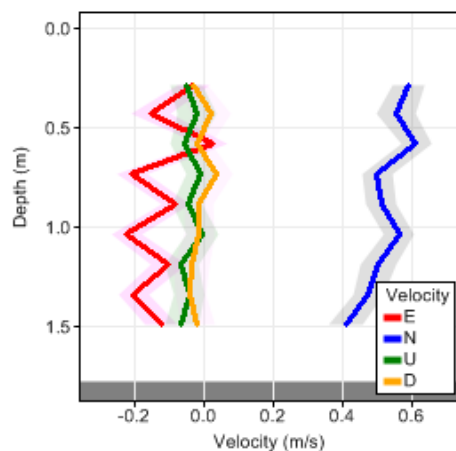

Figure 103. Profile View – WaterTrack

Another useful plot for the profile graph is to select Summary and then Discharge. This will present a graph that plots the profile extrapolation with the area under the graph being the incremental discharge for the sample/profile.

8.3.4. Tab Windows Selection

There are five views or data tabs in the software. Each tab presents a specific view of the data explained below.

8.3.5. Tab Window Display

The Tab Window (Figure 104) shows different views of the data as different tabs are selected. When a tab is selected, it becomes the active tab for all data files which are open in the program. The PageUp and PageDown keys can be used to toggle between the tabs. Below is an explanation of each Tab Window.

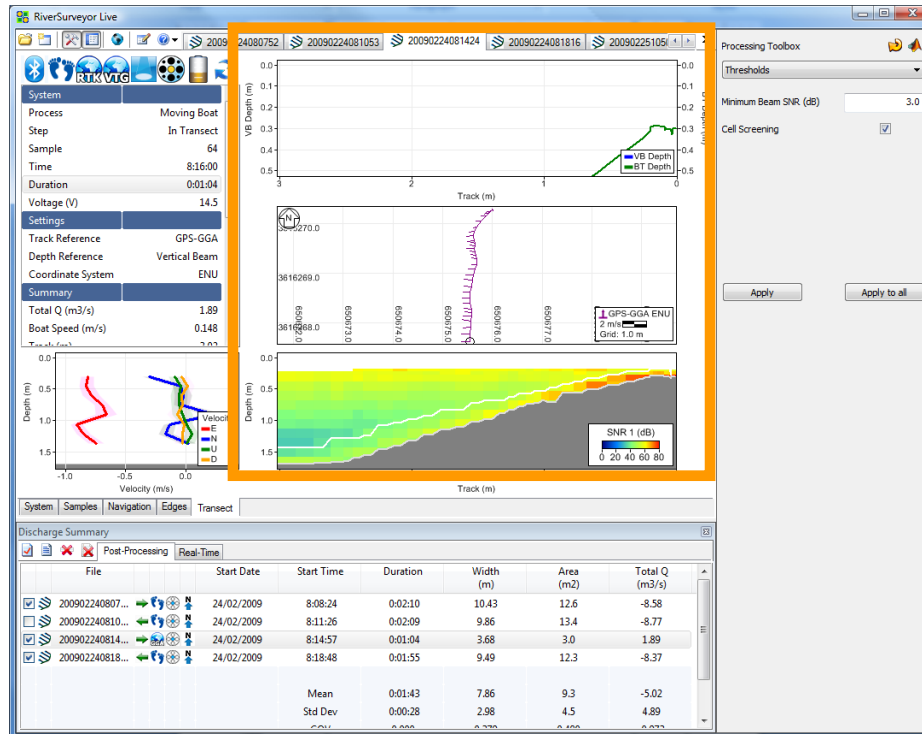

Figure 104. Tab Window Display

System Tab

Figure 105 shows the System tab view of a data file in *RiverSurveyor Live for PC*. To alternate between the views, select the tabs at the bottom of the window to view and analyze the data.

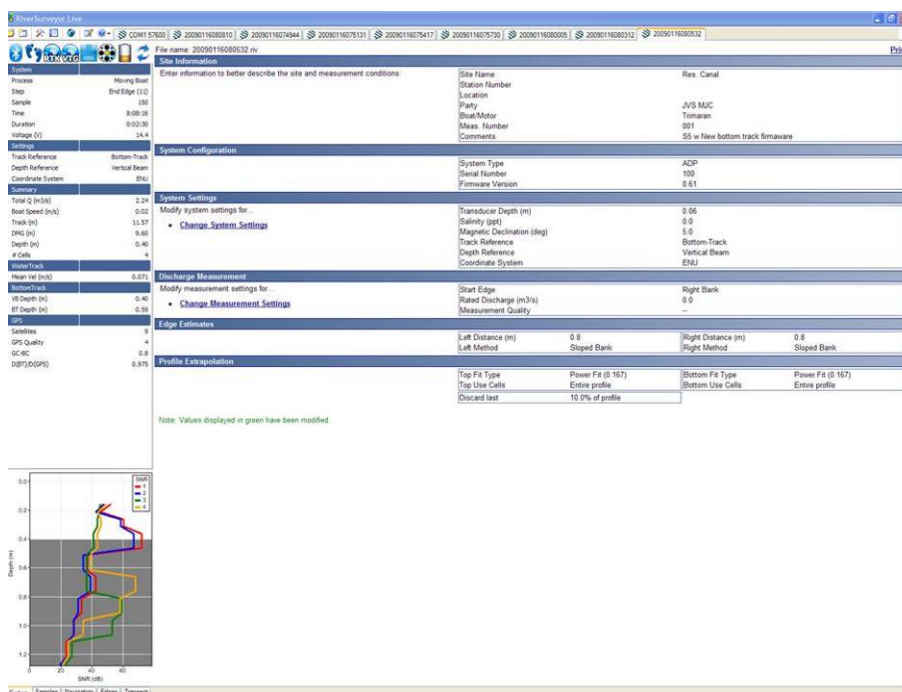

Figure 105. System Tab

The information on the Systems tab shows the following user inputs and settings.

- **Measurement Type** shows the method used to collect the data. Moving Boat is the only option available currently. Other measurement types will be available in future releases.
- **Site Information** shows a summary of Site Information entered before data collection.
- **System Configuration** shows the System Configuration used during data collection.
- **System Settings** shows a summary of the System Settings. Information in this block can be modified for post-processing by clicking Change System Settings.
- **Discharge Measurement** shows a summary of Measurement Settings. This information can be modified for post-processing by clicking on Change Measurement Settings.
- **Edge Estimates** shows a summary of information entered during the measurement.
- **Profile Extrapolation** shows a summary of how the profile data was extrapolated for velocity profiles and discharge measurement.

Important: You can modify the presentation of graphic and tabular data displays by right clicking and selecting from the options in the context menu.

Samples Tab

The Samples tab (Figure 106) displays tabular data for all samples collected along with a contour and profile graph. The left side shows status icons for each sample. The main window shows tabular transect data. You can scroll through the data using the up/down keys or predefined Hotkeys/Accelerators (Section 8.4) for viewing and post-processing. The graphics at the bottom show vertical profile data and complete transect data. You can toggle through the vertical profile data using the up/down keys to browse the samples and use the left/right arrow keys to start at the left/right bank respectively.

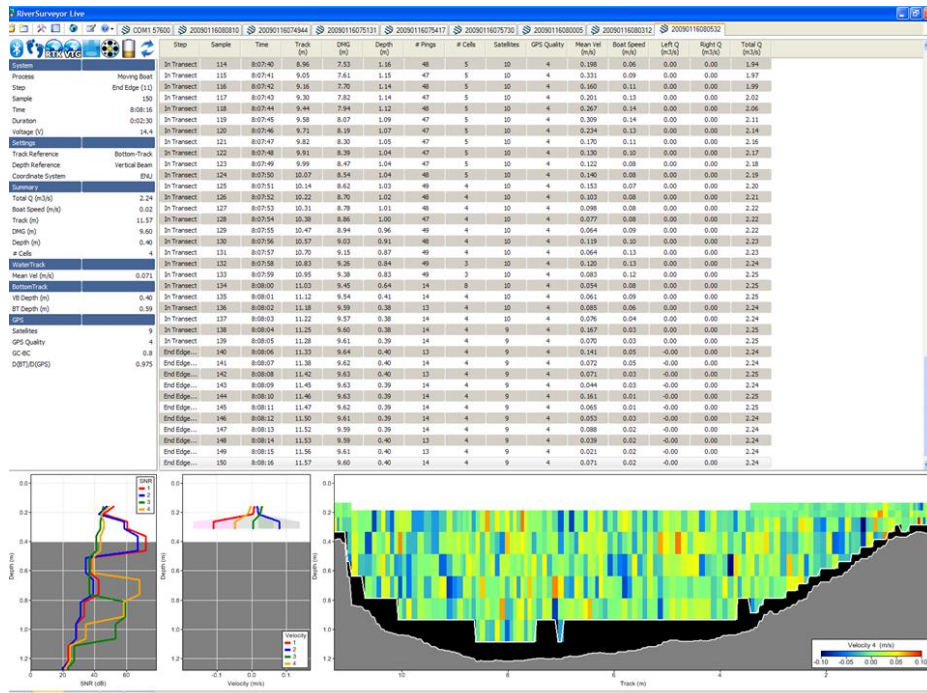

Figure 106. Samples Tab

Navigation Tab

The Navigation tab (Figure 107) has three sections – incremental profile data (left), navigational graphics (main area) and transect view (bottom). The navigational graphics show system trajectory or navigation during the measurement. You can also view collected data superimposed over your own background graphic.

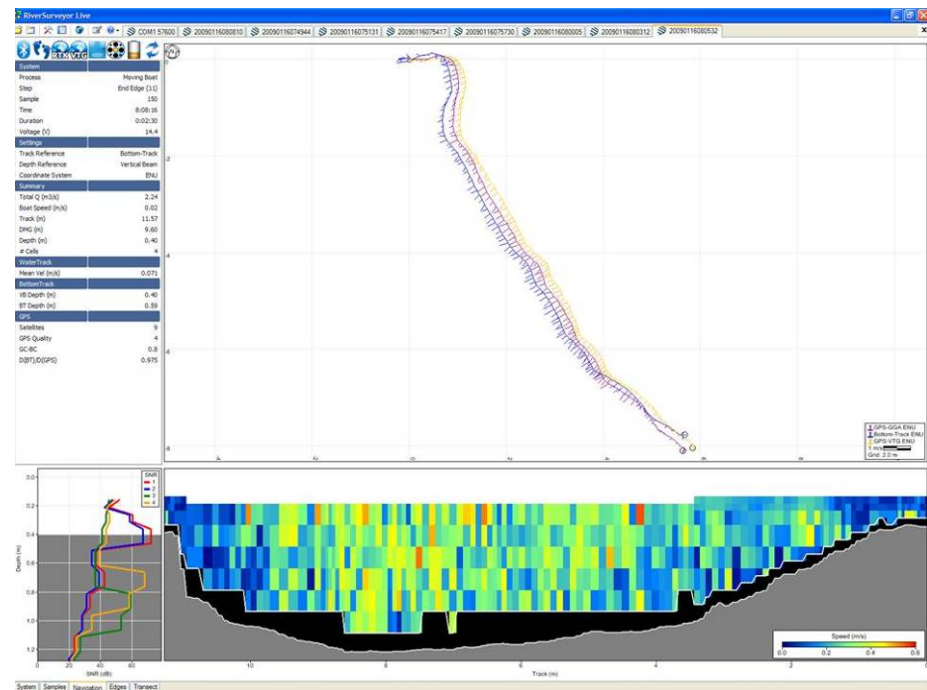

Figure 107 Data View – Navigation Tab

Edges Tab

The Edges tab (Figure 108) provides a detailed tool for evaluating data collected on the start/end edges of a discharge measurement. The Edges tab has three sections – incremental profile data (left), navigation data for both edges (main) and transect data for both edges (bottom).

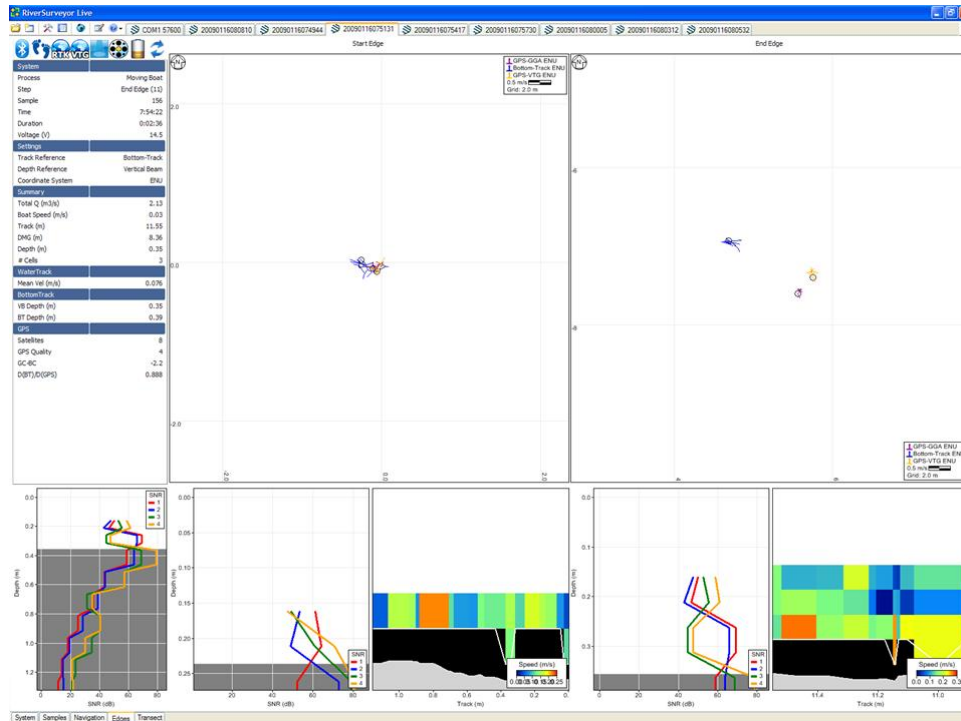

Figure 108. Data View – Edges Tab

Incremental Profile Data – Presents the incremental profile data collected in the field. The up/down keys page through the data one sample at a time. The left arrow key goes to the first profile of the starting edge; the right arrow key goes to the last profile of the ending edge. The information presented in this section allows evaluation of the data from each sample. Status icons help to determine system performance.

Navigation Graphics – Present a view of the trajectory of the system during a measurement. The left arrow key goes to the first profile of the starting edge; the right arrow key goes to the last profile of the ending edge. The up/down keys cycle through the data.

Edge Graphics – Presents a view for evaluating starting and ending edges. The left arrow key goes to the first profile of the starting edge; the right arrow key goes to the last profile of the starting edge. The up/down keys cycle through the data.

Transect Tab

The Transect tab (Figure 109) has three sections – incremental profile data (left), user-selected graphics (main area) and transect view (bottom). As an example, the top graph in Figure 109 shows the depth-to-bottom information taken from the vertical beam data (blue) and the transducer data (green).

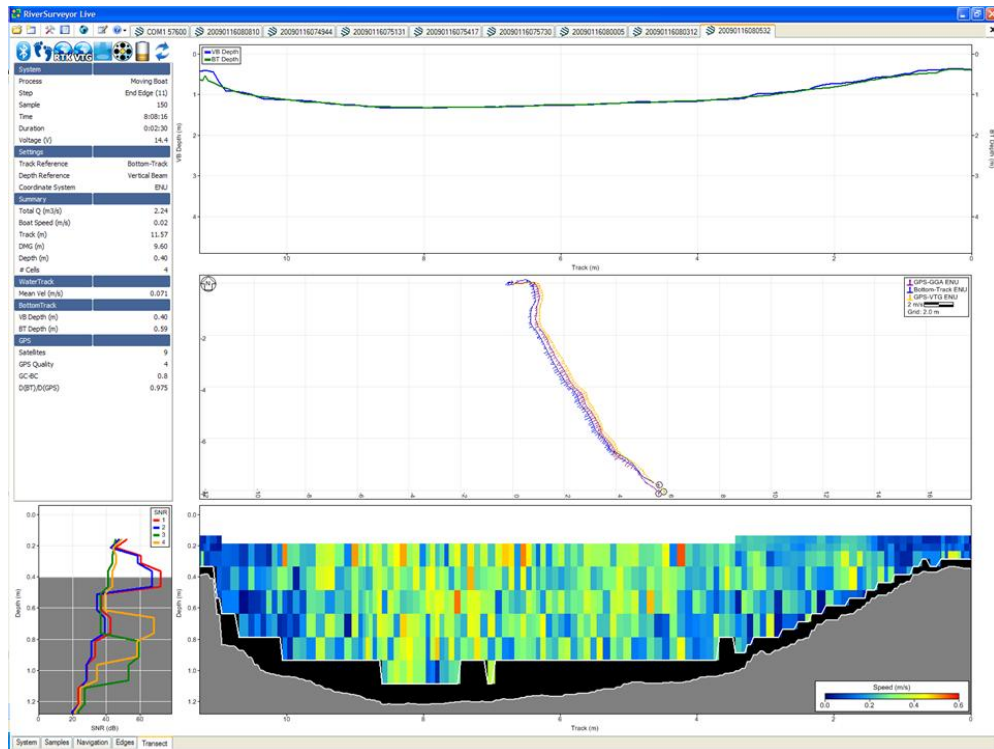

Figure 109. Data View -Transect Tab

Graphs can be modified by right-clicking on the left or right vertical axis and selecting from the options provided. The middle graph displays the path of the boat with the velocity vectors. The velocity vectors at a good site should be roughly perpendicular to the path of the boat.

The bottom graph shows the measured transect with the vertical profile data included. Right-clicking allows various plotting options, while left-clicking provides scaling options. In this window, using the up/down keys allows you to cycle through the data, profile by profile, changing all the graphs simultaneously. This displays the same data from different perspectives along the transect.

8.3.6. Discharge measurement summary



By clicking the Discharge Summary icon, you can show or hide the Discharge Summary window at the bottom of the desktop. This window presents the collected data in tabular format and includes the status icons to evaluate the measurement (Figure 110). If desired, resize the window by using the slider arrow when the mouse pointer is positioned over the window border.

Discharge Summary							
Post-Processing							
Real-Time							
File	Start Date	Start Time	Duration	Width (m)	Area (m ²)	Total Q (m ³ /s)	
<input checked="" type="checkbox"/>	20090224080752.riv	24/02/2009	8:08:24	0:02:10	10.43	12.6	-8.58
<input checked="" type="checkbox"/>	20090224081053.riv	24/02/2009	8:11:26	0:02:09	9.86	13.4	-8.77
<input checked="" type="checkbox"/>	20090224081424.riv	24/02/2009	8:14:57	0:02:44	10.91	13.4	-8.65
<input checked="" type="checkbox"/>	20090224081816.riv	24/02/2009	8:18:48	0:01:55	9.49	12.3	-8.37
			Mean	0:02:15	10.17	12.9	-8.59
			Std Dev	0:00:18	0.54	0.5	0.15
			COV	0.000	0.053	0.038	-0.017

Figure 110. Discharge Measurement Summary

All records are ordered by date/time with icons for starting edge, depth and track reference and coordinate system. All records can be selected or deselected by clicking with the mouse; this affects the statistics presented and is a quick and easy way to understand what effect each measurement has on the overall average of the measurements for the site.

Additionally, you can select data to include or exclude from the discharge calculation by simply clicking to activate or deactivate the check box. The Discharge Summary has the following options that can be used in post processing:



Discharge Summary Report: Generates a printer friendly report that summarizes all data used in the discharge calculation as well as the associated statistics (unchecked records are not displayed).



Export Discharge Summary to ASCII: Exports the information found in the discharge summary to an ASCII file (.txt).



Delete selected discharge record(s): Deletes the selected records (the ones with the red check). These records will not be used for the discharge calculation.



Delete all discharge records: Deletes all records present, essentially removing all transects for discharge calculation

Links between open files and records on the discharge summary are as follows:

- An open file will update its corresponding discharge record with changes to settings or as sample number changes.
- Closing a file leaves the record displayed in the discharge measurement summary, but the record will no longer update
- Deleting the record severs the link to the data file. To add the record back, the file must be reopened.
- Click on a record to switch to the matching data file.
- Delete or uncheck a record to recompute statistics.

8.3.7. **Processing toolbox**



The Processing Toolbox (Figure 111) gives you access to tools to post-process the discharge data. The Processing Toolbox has the following options in its dropdown menu: System Settings, Edge Estimates, Profile extrapolation and Thresholds. Each is described in detail below.

The two icons in the top right corner are always present in the Processing Toolbox.



The Reset icon allows you to reset all modified values back to those entered in the field. Since any changes to the settings have an impact on the discharge calculation, this option is important for users to have the option of post-processing, but the luxury of not losing the initial field settings.



The MATLAB icon exports data from *RiverSurveyor Live* to a MATLAB friendly format explained in Appendix C. The velocities, track and summary data are exported in the reference and coordinate system that are set at the time of export.

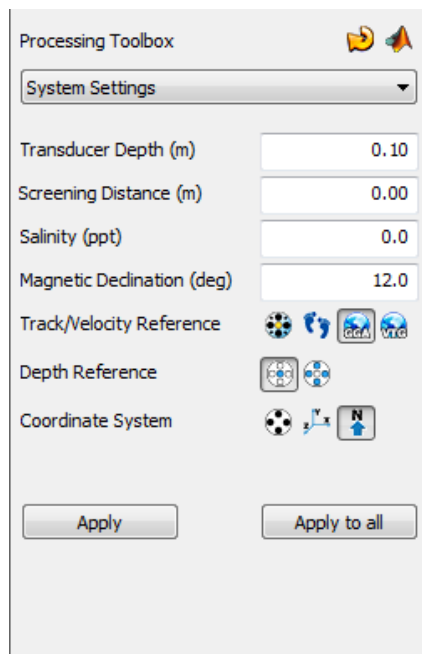

Figure 112. System Settings - Processing Toolbox

Edge Estimates (Figure 113) – Allows the modification of Left/Right Bank settings in order to better define the characteristics regarding channel width and the slope of the edges. These settings have an important impact on the discharge calculation. Left/Right Method are selected from a dropdown box. Left/Right Distance and Estimated Flow are manual entry fields.

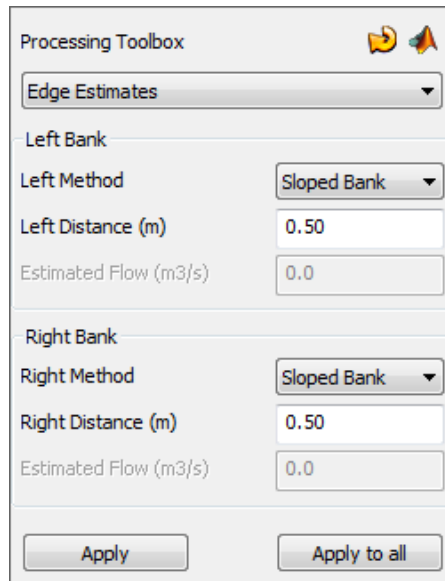

Figure 113. Edge Estimates - Processing Toolbox

Profile Extrapolation (Figure 114) – Allows you to change the way the top/bottom estimates are calculated. In general, the default settings are adequate for most applications. The Method, Cells to Use, and % of Profile fields have dropdown menus. The Coefficient, Discard Last, and Cell(s) fields are manual entries.

The screenshot shows the 'Processing Toolbox' window with the 'Profile Extrapolation' tab selected. The interface is organized into several sections:

- Top Extrapolation:**
 - Method: Power Fit (dropdown)
 - Coeff: 0.167 (text input)
 - Cells to use: Entire profile (dropdown)
 - 1 cell(s) (text input)
- Bottom Extrapolation:**
 - Method: Power Fit (dropdown)
 - Coeff: 0.167 (text input)
 - Cells to use: Entire profile (dropdown)
 - 1 cell(s) (text input)
- Profile Range:**
 - Discard last: 10.0 (text input)
 - % of profile (dropdown)

At the bottom of the window are two buttons: 'Apply' and 'Apply to all'.

Figure 114. Profile Extrapolations - Processing Toolbox

Thresholds (Figure 115) – Shows an option to set the minimum beam SNR threshold used for water velocity calculations (default = 1.0 dB). This value corresponds to the minimum SNR value needed to make a water velocity measurement. In clear water the SNR values are lower, and an adjustment can be made to the threshold to compensate for low sediment load. **Important:** No changes will be made to the calculated discharge or associated data until Apply or Apply to All has been clicked. Apply only applies the post-processing options to the open/active tab; Apply to All applies the post-processing changes to all the active tabs.

The screenshot shows the 'Processing Toolbox' window with the 'Thresholds' tab selected. The interface includes:

- Minimum Beam SNR (dB):** A text input field containing the value 3.0.
- Cell Screening:** A checkbox that is checked.

At the bottom of the window are two buttons: 'Apply' and 'Apply to all'.

Figure 115. Thresholds - Processing Toolbox

8.3.8. SonTek File Manager

 The SonTek File Manager icon opens the SonTek File Manager window (Figure 116) which enables the user to search a user specified directory containing RiverSurveyor Live files, over a specified date range by fields such as file name, site name, location, operator, comments, etc. Files found and displayed in the search results can be double clicked to open in RiverSurveyor Live or multiple files can be selected and all opened by hitting enter.

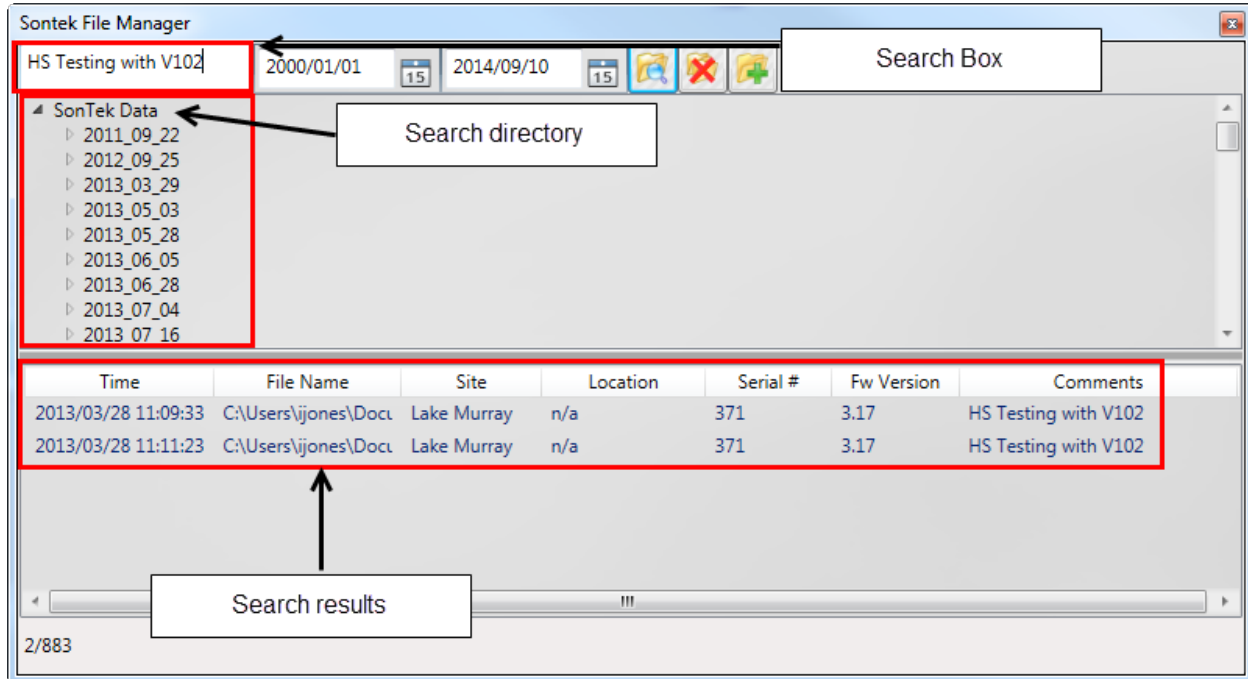

Figure 116. SonTek File Manager



Add a folder that contains RSL files to search. This must be done prior to entering any search criteria.



Delete all currently selected folders to search. Use this function to delete the currently specified folder add a new folder or sub-folder to restrict the search to this folder.



Search specified folder(s) for RSL files containing the specified text string or date over the specified date range.

8.3.9. Compress Measurement Files



The compress file feature allows the user to create a single file containing all the measurements files, tests, calibrations, data exports and edits performed during post processing. This feature promotes good data management practices and is a valuable tool for users, data auditors and data managers.

Compress Files

The Compress Files feature creates a compressed file with an *.RS extension of all measurement files opened in RiverSurveyor Live (RSL) and the associated files located in the source folder. The default filename created for the compress file is yyyy.mm.dd_hh.mm.ss.RS. The

files types that are included in compressed file with the respective criteria are summarized in Table 6.

Table 6. Compress File Types

File Extension	File Type	Format	Source	Action
*.RIVR	Measurement	SonTek	RiverSurveyor Live	Real-Time
*.RIV	Measurement	SonTek	RiverSurveyor	Real-Time
*.txt	System Test	ASCII	RiverSurveyor Live	System Test
*.ccal	Compass Calibration	ASCII	RiverSurveyor Live	Compass Calibration
*.wsp	Work Space File	SonTek	RiverSurveyor Live	Post Processing
*.mat	Matlab	Matlab	RiverSurveyor Live	Export
*.snr	SNR	ASCII	RiverSurveyor Live	Export
*.sum	Summary	ASCII	RiverSurveyor Live	Export
*.vel	Velocity	ASCII	RiverSurveyor Live	Export
*.dis	Discharge Summary	ASCII	RiverSurveyor Live	Export

Data integrity and continuity is the main principle on which the “Compress File” feature is based on and the following aspects need to be taken into account when using the “Compress File” feature.

- Only measurement files opened in RiverSurveyor Live and associated files listed in the Table 6 will be added to the compressed file.
- Compress file feature will only add one “Loop Method” file to the compressed file. Only one Loop Method file can be opened at a time in RiverSurveyor Live.
- Compress file feature will not add a “Loop Method” and “SMBA” files to the same compressed file. Only one method can be opened in RiverSurveyor Live at a time.
- Measurement files that are unchecked in the “Discharge Summary” will also be added to the compressed file.
- Only the files associated with the specific measurements should be in the source folder. There is no verification done on .pdf and .dis files in the source folder. Any file with the .pdf and .dis extension will be added to the compress file,
- File extensions not included in Table 6 will not be added to the compressed file.

Decompress Files

Compressed Files can be opened using the “Decompress Files” feature. RiverSurveyor Live will create a sub-folder in the same location and with the same name as the *.RS compress file located. The sub folder will contain all the measurement files that were opened in RiverSurveyor Live and associated files. The following aspects need to be taken into account when using “Decompress Files” feature,

- A folder “CompassCal” and “SystemTest” is created with in the “Sub-Folder”. The folders contain compass calibration and system test files respectively.
- A warning will be supplied to user that any open transects will be closed before the file is decompressed.

- The “Discharge Summary” will also be cleared of any results from previous transects opened in RiverSurveyor Live.

8.3.10. Load GIS Shape File



The GIS shape file format and import requirements are below:

1) In addition to the *.shp file, the *.dbf and *.shx files of the same name are required to be in the same directory in order for the shape file to open in RiverSurveyorLive. There may be additional components to the shape file when used in other applications, but RSL needs only those three.

2) In RSL, right-click on the map window to make sure the display is in UTM. Units for the program should be Metric.

3) The shape file created in the third-party software needs to be saved in UTM, in meters, NAD83.

4) The following shape file types should work:

SHPT_ARC

SHPT_POLYGON

SHPT_ARCZ

SHPT_POLYGONZ

5) If the shape file doesn't load, try saving it as Polyline before bringing it into RSL. It will not work if the shape file type is Point.

8.4. Hot Keys/Accelerators

Table 7 presents a list of Hotkeys/Accelerators which can be used via the keyboard, often in place of a mouse click. These Hot Keys are useful in many processes including data collection, data processing, managing data files and viewing data. It is also important to remember for graphic and tabular display, a right-click presents data viewing options.

Table 7. Summary of Hotkeys/Accelerators for RiverSurveyor Live for PC

Hot Keys	Description/Function	Location/Process
F5	Go to Next Step	Data Collection
F8	Abort	Data Collection
Ctrl+N	Connect to RiverSurveyor System	Start Data Collection
Ctrl+O	Open a data file	Data Processing
Ctrl+T	Show/Hide Processing Toolbox	Data Processing
Ctrl+S	Show/Hide Discharge Measurement Summary	Data Processing
Ctrl+R	Show Discharge Summary Report	Data Processing
Ctrl+Tab	Next File/Connection Tab (top of screen)	Data Processing
Ctrl+Shift+Tab	Previous File/Connection Tab (top of screen)	Data Processing
PageUp	Next Display Tab (bottom of screen)	Data Processing
PageDown	Previous Display Tab (bottom of screen)	Data Processing
Ctrl+F4	Close Current Tab	Data Processing
Ctrl++	Increase Vector Length	Track Window
Ctrl--	Decrease Vector Length	Track Window
Z	Zoom in	Track Window
Shift+Z	Zoom out	Track Window
Left Arrow	First Sample	Data Files
Right Arrow	Last Sample	Data Files

Up Arrow	Previous Sample	Data Files
Down Arrow	Next Sample	Data Files
Ctrl+Up Arrow	Back 20 Samples	Data Files
Ctrl+Down Arrow	Forward 20 Samples	Data Files
Ctrl+Shift+Up Arrow	Back 100 Samples	Data Files
Ctrl+Shift+Down Arrow	Forward 100 Samples	Data Files

8.5. Processing Data Files – Step by Step

This section is a guide for analyzing and post-processing data files collected in the field.

1. Open all files from a measurement site (the same measurement site with the same flow conditions).
 - Review the System settings. Be sure that the settings are consistent amongst files. To do this go to the Systems tab and cycle through each file (Click on each tab individually or use Ctrl+Tab).
 - If necessary, change the Track and Depth reference to best represent the best field measurement (in Processing Toolbox – System Settings).
 - Select the Navigation tab to evaluate the collected data across the channel. Deactivate the UTM Display and activate the AutoScale option: available by right clicking.
 - Use the Sidebar tabular data to evaluate specific settings (i.e. Duration of the measurement, GPS Quality).
 - Visually review each measurement by clicking on each tab or by using Ctrl+Tab
 - Evaluate BottomTrack vs. GPS (if applicable) to observe any compass, GPS or moving bed issues.
 - Make sure the magnetic declination is set appropriately for the site (the default setting is zero).
 - Make sure that the GC-BC (angle of average GPS course since start of transect minus ADP bottom-track course; value near 0 is desired) is less than 2 degrees and the D(BT)/D(GPS) (Ratio of Bottom Track track distance to GPS track distance) is approximately 1 (Sidebar data).
 - Be sure the number of GPS satellites is good and the GPS quality is valid

2. On the Transect tab, evaluate different plots by right-clicking on the vertical axes.
 - Plot the depth measured by the Vertical Beam as well as Bottom Track depth. Make sure the VB and BT depth scales are the same. Check for any major discrepancies.
 - Evaluate Boat Speed and Water speed plotted on the same graph. Ideally, the Boat speed should not exceed the water speed where possible.
 - Make sure that Heading/Pitch/Roll and Temperature are relatively constant.
 - Verify that the SNR data and beams are valid with special focus on the edges and shallow water.
 - Verify water velocity in ENU: U (up) and D (Delta) should be close to zero.
 - Make sure that discharge curve and profile extrapolation is applicable (using Processing Toolbox – Profile Extrapolation).
 - Verify that the SNRs are valid for the contour (graph at the bottom).
 - Verify that the velocity cell cutoff on the contour plot is valid, also look at the screening distance and make sure that is graphically correct.

3. In the Discharge Measurement Summary make sure that:
 - References and Coordinates should be the same
 - Starting edges should alternate





- Date/times should be consecutive
- Duration of measurements should be similar
- Use the Statistics to identify any outliers
- Channel width and discharge areas should be similar
- Uncheck or delete problematic records

Appendix A. Description of RiverSurveyor Live Icons

Bluetooth is a wireless short-range communications technology allowing data transmission over short distances from fixed and mobile devices. When users apply this method of communication between their PC or Mobile device and the ADP, a blue icon indicates that Bluetooth is active, while a red icon represents inactive (icons below). Bluetooth signal strength is indicated with a green icon square, a full square indicates a strong Bluetooth signal, while squares not completely filled indicates proportional signal strength.



Bottom Track is used to remove vessel motion from measured water velocity to determine the “true” water velocity, track distance and depth. That is, when you mount the ADP to a vessel, bottom-track measures the velocity and direction of the ADP/vessel movement over ground. There are four icons (below) for bottom track quality: blue corresponding to depth and track data (optimal); yellow means bottom track only depth is valid (functional); red indicates that bottom track does not have a lock; and the grey icon indicates that the feature is not available.





				
Depth	Valid	Valid	Invalid (no lock)	Disabled /Inactive
Track Velocity	Valid	Invalid (no lock)	Invalid (no lock)	Disabled /Inactive

RTK GPS is the essential GGA GPS fix data which provides 3-D location and accuracy data for the system. This data string includes: Latitude, Longitude, Fix quality, Number of satellites used, Altitude as well as many other types of information. There are five icons for RTK GPS, as seen below, ranging from RTK (Real-time kinematic--blue) to the Inactive (gray). The RTK and DIF icons will toggle between each other as the GPS acquires an RTK lock. All icons will be blue when an RTK lock has been achieved.

				
4	2	1	0	
RTK Quality Position	Differential Quality Position	Uncorrected Position	Invalid or no data	Disabled /Inactive

- RTK Quality GPS provides 0.03 m accuracy
- Differential Quality GPS provides sub 1-meter accuracy
- GGA Uncorrected provides greater than 1-m accuracy

VTG is the GPS vector track and speed over ground data string for the system. The VTG (Vector track and speed over ground) data string presents Track and ground speed information (boat speed over the water) as well as other information. There are four icons (below) for VTG ranging from Measured Velocity (blue) to Inactive (grey).

			
Valid Velocity	Valid Velocity* (Limited Satellite Coverage)	Invalid or no data	Disabled /Inactive

*Acceptable for discharge measurements but additional GPS parameters should be monitored for guidance.

See Appendix D—Troubleshooting for additional guidance on using VTG data.

Depth Reference refers to the method used to measure depth. The RiverSurveyor presents two options for Depth Reference: Vertical Beam (using the echo sounder) and Bottom Track (using the velocity transducers). The indicator for no depth lock is the red icon, meaning that water depth cannot be determined. The grey icon below indicates the depth reference is not available.

			
Vertical Beam	BottomTrack	No Depth Lock	Disabled /Inactive

System Connection indicates that the system is connected and communicating with external sources (PC or Mobile device).



System Connected

System Battery is monitored using the status icons indicated below. Typically, a fully charged battery pack has about 5 hours of use. The icons below indicate battery status ranging from 10 to 100%. Users are advised to change the system battery immediately after reaching the 10% level in order to prevent loss of data. If applying a direct power source to the ADP, the icon below will still be applied and with 17 V applicable to 100% and 12 V corresponding to 10%.

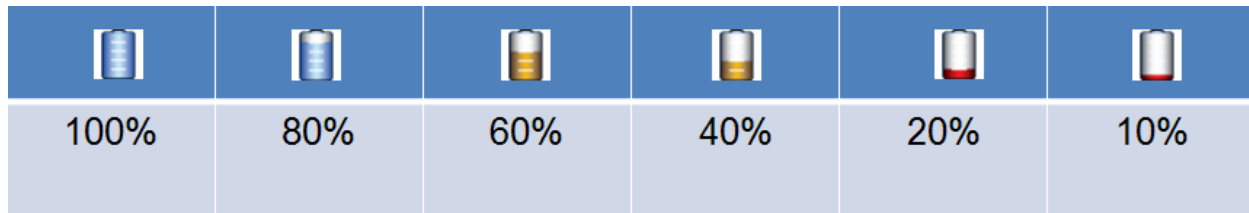

Data Collection is verified using the two icons below. Blue rotating arrows indicate that the system is actively collecting data. The red clock-like icon indicates that the system is not collecting data and a detailed review of system and application settings should be completed in order to identify any possible problems.

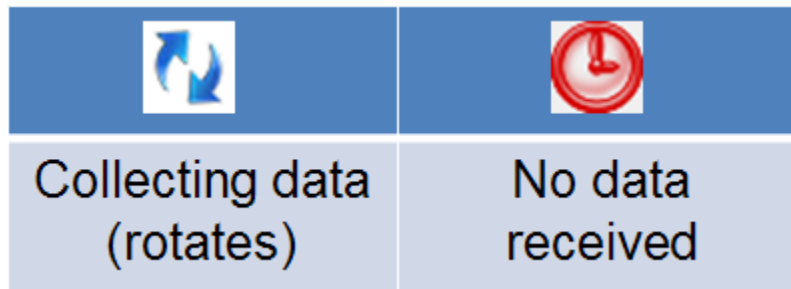

- **Collecting Data** – During data collection the blue arrows (above) will move in a circular motion, indicating that data collection is active.
- **No Data Reception** – The red icon (above) indicates loss of communications. Re-check communications connections and the range of the system.

RiverSurveyor Live for PC Menu Bar is used for the initial setup and startup. Icon utilities are self-explanatory; however, a brief description is included below:



Open File (Ctrl + O) – Opens a window that allows users to select files to open and evaluate using post-processing tools.



Connect (Ctrl + N) – Allows the selection of communications types with the RiverSurveyor: for a direct connect option or a SS radio connection select a Com Port, while Bluetooth users should click on the tick-box at the bottom of the window.



Show/Hide Processing Toolbox (Ctrl + N) – Toggle button shows or hides the Processing Toolbox for post-processing analysis.



Show/Hide Discharge Summary (Ctrl + S) – Toggle button shows or hides the Discharge Summary for post-processing analysis.



Load GIS Shape File – Opens a window with options to look for and load pre-saved geo referenced Shape File that can be used as a background for the data collected. This is a useful visualization tool for user in post-processing.



Change Program Settings – Opens a pop-up window displaying the program settings options



View Documentation – Presents help documents.

Discharge Summary Menu Bar (Desktop version) presents four icons that allows various post processing options and are described below:



Discharge Summary Report – Opens a printer-friendly window that presents the collected data in a pre-defined report format.



Export Discharge Summary to ASCII – Opens a dialog box that allows a file to be saved in ASCII format. The file has a plain text format for importing the data into another application for further processing.



Delete Selected Discharge Record(s) – A post processing option used to delete a record in the Discharge Summary Window. This option will have an effect on the overall discharge measurement summary as the record is deleted from the summary; however, the file is still saved in PC or Mobile device memory. Multiple records can be selected and deleted by checking the tick-mark boxes next to the record.



Delete All Discharge Records – Using the Delete All Records button deletes all loaded records from the Discharge Summary.

Processing Toolbox Icons (Desktop version)



Reset to Field Settings – Allows you to reset the values that were used in the field for the discharge calculation.



Export to MATLAB – Opens a pop-up window used to name and save the file for import into MATLAB.

Coordinate System Icons (Desktop version)



Beam Coordinates – Beam coordinates are relative to the orientation of the transducers on the head of the ADP. Beam coordinates are typically used for diagnostics purposes only.



XYZ Coordinates – Transforms beam velocities into a typical right-hand XYZ Cartesian coordinate system. The positive X axis is in the direction of beam 1, marked by an arrow next to the transducer. The positive Z axis is up.



ENU Coordinates – Applies the ENU (East, North, Up) coordinate system to the data. Local ENU coordinates are formed from a plane tangent to the Earth's surface fixed to a specific location.

Depth Reference (Desktop Version)



Vertical Beam – Applies data from the 0.5 MHz transducer for M9 systems and the 1.0 MHz data from the S5 system to determine water depth for the cross-sectional area.



Bottom Track – Applies data from the velocity transducers from the S5 (four 3 MHz transducers) and M9 (four 3 MHz transducers and four 1 MHz transducers) to determine water depth for the cross-sectional area.

Appendix B. Parameter and Hotkey Descriptions

This appendix describes the parameters that can be displayed during data collection using the RiverSurveyor Live for Mobile software. There are a number of views available during data collection. Each may be accessed using a Hotkey or selecting a viewing option from the menu. Typically, six to twelve parameters or settings are displayed at one time. Press one of the hot-keys (1-4) during data collection using the Mobile device to change to a different view.

Parameter	Description	Key/Menu Option
Process	Moving Boat (Default)	1
Step	Profiling (default)	1
Sample	Number of samples taken (typically 1 per second)	1
Time	Time set by the user	1
Duration	Duration of the measurement (HH:MM:SS)	
Voltage	Voltage of system battery on RiverSurveyor	1
Total Q	Total accumulated discharge for the transect	1
# Cells	Number of cells used in the last vertical profile	1
Track	Shows the accumulated total distance the vessel has traveled through the last completed profile for this data set	1
Depth	Depth measured for the last profile processed (m or ft)	1
Mean Vel	Mean velocity of last profile in m/s or ft/s	1
Boat Speed	Shows speed of vessel over ground for the last profile processed	1
Boat/Water	Ratio of boat speed to water speed	2
DMG	Distance made good is the distance from your last position to your present position	2
Temperature	Temperature in °C or °F (system settings Metric or English) for the last profile processed	2
Heading	Shows vessel heading based on the Track Display	2
Pitch	Shows the pitch angle of the ADP for the last profile processed	2
Roll	Shows the pitch angle of the ADP for the last profile processed	2
Satellites	Number of satellites used in location determination (GPS option)	2
GPS Quality	Quality indicator based on number of satellites used in track data	2
D(BT)/D(GPS)	Ratio of Bottom Track distance to GPS track distance	2
GC-BC	Shows angle (degrees) of average GPS course since start of transect minus ADP bottom-track course; value near 0 is desired.	2
BMG-GMG mag	Magnitude of vector between bottom-track-made-good distance and GPS-made-good distance	2
BMG-GMG dir	Direction of vector between bottom-track-made-good distance and GPS-made-good distance	2
GPS Age	Age of differential GPS connection in seconds	2
HDOP	Horizontal dilution of precision	2
Total Q	Total discharge measure for the cross section in m ³ /s or ft ³ /s	2
Top Q	Shows the total accumulated discharge in the top layer that is estimated by the program	3
Middle Q	Shows the total accumulated discharge in the middle layer that is estimated by the program	3

Bottom Q	Shows the total accumulated discharge in the bottom layer that is estimated by the program	3
Left Q	Shows the total accumulated discharge in the left edge of the survey area that is estimated by the program	3
Right Q	Shows the total accumulated discharge in the right edge of the survey area that is estimated by the program	3
Total Q	Shows total discharge estimated and measured for entire cross-section	3
Transducer Depth	Distance the vertical beam transducer is submerged into water column	4
Salinity	User defined parameter that allows for a correction of the speed of sound in water based on the salinity in parts per thousand (ppt)	4
Magnetic Declination	User defined value for difference in magnetic North and true North	4
Track Reference	User defined criteria used in determining navigation information (i.e. Bottom Track and Boat Speed)	4
Depth Reference	User defined criteria used in determining water depth (i.e., Vertical Beam or Bottom Track (4 beams))	4
Coordinate System	Navigation coordinate system applied by user (ENU, System, XYZ)	4

Appendix C. MATLAB Export

The MATLAB output is ordered into a series of structures each containing their related parameters and settings. The tables below describe each structure and its contents. It is current as of version 3.90 of the RiverSurveyor Live software. From the toolbar, there are two options: “MATLAB export” and “MATLAB export all”. “MATLAB export” exports the currently viewed transect and “MATLAB export all” exports all currently opened transects. All *.mat files are saved using the same file name as the source *.riv or *.rivr file in the same directory in which they are stored.

IMPORTANT NOTES:

- The term “sample” refers to a single vertical profile, taken over a period of 1 s.
- For the four parameters containing *Velocity* data (BottomTrack.BT_Vel, Summary.Mean_Vel, Summary.Boat_Vel, and WaterTrack.Velocity), the data is in the same coordinate system that was selected in the software when the .mat file was exported. For example:
 - BT_Vel when exported in *ENU coordinates* will be:
 1. East Velocity (i.e. velocity to the East)
 2. North Velocity
 3. Up Velocity
 4. Difference Velocity (aka Error Velocity; the difference between measuring the vertical component of the velocity from the two pairs of opposing beams)
 - BT_Vel when exported in *XYZ coordinates* will be:
 1. X Velocity
 2. Y Velocity
 3. Up Velocity
 4. Difference Velocity
 - BT_Vel when exported in *Beam coordinates* will be:
 1. Beam 1
 2. Beam 2
 3. Beam 3
 4. Beam 4
- GPS Altitude (from the GGA string) is based on a proprietary, non-published geoid, and referenced to the bottom-center of the antenna.

The basic order of the root structures is as follows. For the Size Column:

- NS is the number of samples;
- NC is the maximum number of cells;
- If the structure contains another structure inside it, or the parameter is a scalar, the size is NA.

Structure Name	Description
Bottom Track	Bottom Track Velocity, Depth and Frequency variables (includes Vertical Beam).
GPS	GPS data and quality information.
Processing	Processing settings.
RawGPSData	The raw GPS data from either the internal GPS or an external serially connected GPS system. This data is stored in its raw format with the same frequency that was output from the GPS. For example, if the GPS outputs data at 10 Hz, then 10 GPS data values are stored for each ADP sample.
Setup	System settings, edge information and profile extrapolation

Stationary*	Individual station data
Summary	Calculated discharge variables and the data used to compute them.
System	Core system related parameters: Compass, Temperature, Time, SNR, Voltage and Profiling settings
Transformation_Matrices	System frequencies and transformation matrices
WaterTrack	Water velocity and profiling variables in coordinates selected for output
Compass	Compass pitch, roll and magnetic error
SystemHW	Serial Number, Firmware Version, Beam Info

*This structure is only exported from RiverSurveyor Stationary software

Bottom Track structure

Parameter Name	Description	Size
VB_Depth	Vertical Beam depth for each sample, including the Transducer Depth and compensation for tilt	NS x 1
BT_Depth	Mean Bottom Track depth for each sample, including the Transducer Depth and compensation for tilt. This is the mean of the depth measured by each active transducer and projected in vertically below of the ADP	NS x 1
BT_Vel	Bottom Track Velocity for each direction (or beam, if exported in Beam coordinates) for each sample	NS x 4
BT_Beam_Depth	Bottom Track depth for each beam for each sample, including the Transducer Depth and compensation for tilt	NS x 4
BT_Frequency	Frequency of Bottom Track data for each sample (correlate with Frequency parameter from Transformation_Matrices structure)	NS x 1
Units	Units for above parameters (BT_Frequency is kHz)	NA

GPS structure

Parameter Name	Description	Size
Longitude	Last valid 10 Hz GGA sample Note: Only applicable when Track Reference is GGA	NS x 1
Latitude	Last valid 10 Hz GGA sample Note: Only applicable when Track Reference is GGA	NS x 1
Utc	Universal Time Coordinated (UTC) for each sample, in HHMMSS.S	NS x 1
Satellites	Number of satellites in view for each sample	NS x 1
HDOP	Horizontal Dilution of Precision for each sample	NS x 1
GPS_Age	Time since the last corrected GPS signal received at the rover GPS antenna, whether from the RTK Base Station or from the satellite if using the SonTek DGPS option	NS x 1
Altitude	Altitude above mean sea level for each sample	NS x 1
GPS_Quality	GPS Quality for each sample (5 = RTK float, 4 = RTK fixed, 2 = Differential, 1 = Standard, 0 = Invalid)	NS x 1
GpsGeoid	Gps Geoid Height is the distance between the geoid (mean sea level) and the WGS84 ellipsoid	NS x 1
UTM	Universal Transverse Mercator (UTM) coordinate system in X and Y coordinates for each sample	NS x 2
Units	Units for above parameters (GPS_Age are in seconds)	NA

Processing structure

Parameter Name	Description	Size
Screening	User-applied minimum SNR filtering settings, in dB	NA
Corrections	User-applied heading correction, in degrees	NA

RawGPSData structure (This structure contains 50 columns per sample because the instrument samples the GPS port at 50 Hz. However, because we require the GPS to output normally only up to 10 Hz, typically only the first 10 columns contain data, while the remaining 40 are filled with 0)

Parameter Name	Description	Size
VtgTimeStamp	\$GPVTG time stamp for each high frequency GPS sample	NS x 50
VtgTmgTrue	\$GPVTG true course made good for each high frequency GPS sample (degrees)	NS x 50
VtgTmgMag	\$GPVTG magnetic course made good for each high frequency GPS sample (degrees)	NS x 50
VtgSogMPS	\$GPVTG speed over ground for each high frequency GPS sample (m/s)	NS x 50
VtgMode	\$GPVTG active mode for each high frequency GPS sample	NS x 50
GgaTimeStamp	\$GPGGA time stamp for each high frequency GPS sample	NS x 50
GgaLatitude	\$GPGGA latitude for each high frequency GPS sample	NS x 50
GgaLongitude	\$GPGGA longitude for each high frequency GPS sample	NS x 50
GgaQuality	\$GPGGA fix quality for each high frequency GPS sample (4 = RTK, 2 = Differential, 1 = Standard, 0 = Invalid)	NS x 50
GgaAltitude	\$GPGGA altitude above sea level for each high frequency GPS sample (m)	NS x 50
GgaUTC	\$GPGGA UTC for each high frequency GPS sample (HHMMSS.S)	NS x 50

Setup structure

Parameter Name	Description	Size
startEdge	Start edge (0 = Left bank; 1 = Right bank)	NA
magneticDeclination	Magnetic Declination (degrees)	NA
transectAzimuth	Transect azimuth (Stationary measurements)	NA
coordinateSystem	Coordinate system (0 = Beam; 1 = XYZ; 2 = ENU)	NA
trackReference	Track reference (0 = System; 1 = Bottom Track; 2 = GPS GGA; 3 = GPS VTG)	NA
velocityReference	Velocity reference (0 = System; 1 = Bottom Track; 2 = GPS GGA; 3 = GPS VTG)	NA
depthReference	Depth reference (0 = Vertical beam; 1 = Bottom Track)	NA
userSalinity	User input salinity (psu)	NA
sensorDepth	Transducer depth (m)	NA
screeningDistance	Vertical screening distance (m)	NA
Edges_0__DistanceTo-Bank	Left Edge: Distance to the bank	NA
Edges_0__EstimatedQ	Left Edge: Estimated discharge	NA

Edges_0__Method	Left Edge: Method (0 = User input discharge; 1 = Vertical bank; 2 = Sloped bank)	NA
Edges_1__DistanceTo-Bank	Right Edge: Distance to the bank	NA
Edges_1__EstimatedQ	Right Edge: Estimated discharge	NA
Edges_1__Method	Right Edge: Method (0 = User input discharge; 1 = Vertical bank; 2 = Sloped bank)	NA
RatedDischarge	User input rated discharge	NA
extrapolation_Top_nFit-Type	Profile Extrapolation - Top: Fit equation type (0 = Constant fit; 1 = Power fit)	NA
extrapolation_Top_nEntireProfil	Profile Extrapolation - Top: Fit (0 = Use entire profile; 1 = User selected number of cells)	NA
extrapolation_Top_dExponent	Profile Extrapolation - Top: Power fit exponent	NA
extrapolation_Top_nCells	Profile Extrapolation - Top: Number of cells used in extrapolation	NA
extrapolation_Bottom_nFitType	Profile Extrapolation - Bottom: Fit equation type (0 = Constant fit; 1 = Power fit)	NA
extrapolation_Bottom_nEntirePro	Profile Extrapolation - Bottom: Fit (0 = Use entire profile; 1 = User selected number of cells)	NA
extrapolation_Bottom_dExponent	Profile Extrapolation - Bottom: Power fit exponent	NA
extrapolation_Bottom_nCells	Profile Extrapolation - Bottom: Number of cells used in extrapolation	NA
extrapolation_nDiscardType	Method for discarding cells at the bottom of the profile (0 = user selected number of cells; 1 = percentage of profile)	NA
extrapolation_nDiscardCells	Number of cells discarded	NA
extrapolation_dDiscard-Percent	Percentage of profile discarded	NA
MeasurementQuality	User input measurement quality	NA
disableAutovelocit	Enable or disable SmartPulse ^{HD}	NA
UserTemperature	User input temperature	NA
fixedSoundSpeed	User input sound speed	NA
useMeasuredTemperature	0 = Use User Input Temperature; 1 = Use Measured Temperature	NA
useFixedSoundSpeed	0 = Use Calculated Sound Speed; 1 = Use User Input Sound Speed	NA
Units	Units for above parameters	NA

Stationary Structure

Parameter Name	Description	Units	Size
user_Input_Water_Depth	Water depth at station input by user	m or ft	NA
water_Surface_To_Bottom_Of_Slush	Distance from the surface of the water to the bottom of the slush ice	m or ft	NA
screening_Distance	Transducer screening distance (similar to RSL)	m or ft	NA
gauge_Height	User-input gauge height	m or ft	NA
auxillary_Gauge_Height	User-input auxiliary gauge height	m or ft	NA
GH_Observation_Time	User-input time for gauge height	Seconds from 01/Jan/2000	NA

coordinate_System	Coordinate system used	N/A	NA
island_Edge	Whether station is an island edge	N/A	NA
station_Samples	Number of samples in station	N/A	NA
station_Start_Location	Location of start of station	m or ft	NA
Location	Location of center of station	m or ft	NA
station_End_Location	Location of end of station	m or ft	NA
station_Mean_Velocity	Station mean velocity	m/s or ft/s	NA
station_Depth	Station depth as measured by system	m or ft	NA
station_Width	Station width	m or ft	NA
averaging_Time	Averaging time	Seconds	NA
station_ID	Total Number of Stations	N/A	NA
Use	Internal counter	N/A	NA
Count	Seconds measured at each station	Seconds	NA
station_Number	Station Number	N/A	NA
top_Fit_Type	Extrapolation type for top fit	N/A	NA
top_Use_Cells	Whether using a set number of top cells or not in extrapolation	N/A	NA
top_Exponent	Exponent used in top extrapolation	N/A	NA
top_Cells	Which cells used for top extrapolation	N/A	NA
top_Percentage	Percentage used in top extrapolation	%	NA
bottom_Fit_Type	Extrapolation type for bottom fit	N/A	NA
bottom_Use_Cells	Whether using a set number of bottom cells or not in extrapolation	N/A	NA
bottom_Exponent	Exponent used in bottom extrapolation	N/A	NA
bottom_Cells	Cells used for bottom extrapolation	N/A	NA
bottom_Percentage	% used in bottom extrapolation	N/A	NA
discard_Last	Whether to discard a fixed number of cells at the bottom	N/A	NA
discard_Cells	Which cells to discard at the bottom	N/A	NA
discard_%	Whether to discard a fixed percentage at the bottom	N/A	NA
Units	Units for above parameters.	N/A	NA

Summary structure

Parameter Name	Description	Size
Top_Q	Discharge for the top section for each sample	NS x 1
Middle_Q	Discharge for the middle (measured) section for each sample	NS x 1
Bottom_Q	Discharge for the bottom section for each sample	NS x 1
Left_Q	Discharge for the left edge for each sample	NS x 1
Right_Q	Discharge for the right edge for each sample	NS x 1
Total_Q	Total discharge for each sample	NS x 1
Depth	Depth used for discharge calculation for each sample	NS x 1

Cells	Number of cells used for discharge calculation for each sample	NS x 1
Track	Track location for each sample in X and Y coordinates	NS x 2
Mean_Vel	Mean water velocity for each sample, inclusive of the top and bottom extrapolation, for the horizontal velocity components.	NS x 2
Boat_Vel	Boat velocity used for discharge calculation for each sample	NS x 4
Track_Reference	Track reference (0 = System; 1 = Bottom Track; 2 = GPS GGA; 3 = GPS VTG)	NS x 1
Units	Units for above parameters	NA

System structure

Parameter Name	Description	Size
Heading	Compass heading for each sample	NS x 1
Temperature	Temperature for each sample	NS x 1
Time	Time for each sample	NS x 1
SNR	Signal to noise ratio for each cell of each beam per sample	NC x 4 x NS
Sample	Sample number for each sample	NS x 1
Voltage	Battery voltage for each sample	NS x 1
Cell_Start	Start of the first cell for each sample	NS x 1
Cell_Size	Size of depth cells for each sample	NS x 1
Step	Step in data collection process for each sample For Moving Boat Discharge measurement: 2 = Start Edge 3 = In Transect 4 = End Edge	NS x 1
Pings	Number of pings for each sample	NS x 1
Units	Units for above parameters (Time is seconds from 01/Jan/2000)	NA

Transformation matrices structure

Parameter Name	Description	Size
Frequency	Frequencies available for the system	3 x 1
Matrix	Transformation matrices for each frequency	4 x 4 x 3

WaterTrack structure

Parameter Name	Description	Size
Velocity	Each water velocity component for each cell of each sample	NC x 4 x NS
Vel_StdDev	Each standard deviation of water velocity for each cell of each sample	NC x 4 x NS
Correlation	Each correlation score for each cell of each sample. Only applicable for samples collected with SmartPulse ^{HD}	NC x 4 x NS
WT_Frequency	Frequency used for WaterTrack data for each sample (correlate with Frequency parameter from Transformation_Matrices structure)	NS x 1
Amb_Velocity	Ambiguity Velocity for each sample. Only applicable for samples collected with SmartPulse ^{HD}	NS x 1

Units	Units for above parameters (BT_Frequency is kHz)	NA
-------	--	----

Compass structure

Parameter Name	Description	Size
Pitch	Rotation around the M9/S5 y-axis	NS x 3
Roll	Rotation around the M9/S5 x-axis	NS x 3
Magnetic_error	Percentage of magnetic interference compared to calibration	NS x 3
Minimum_Pitch	Minimum rotation around the M9/S5 y-axis	NS x 1
Maximum_Pitch	Maximum rotation around the M9/S5 y-axis	NS x 1
Minimum_Roll	Minimum rotation around the M9/S5 x-axis	NS x 1
Maximum_Roll	Maximum rotation around the M9/S5 x-axis	NS x 1
Units	Units for above parameters	NA

SystemHW structure

Parameter Name	Description	Size
SerialNumber	Instrument Serial Number	1x1
FirmwareVersion	e.g., 3 as in 3.91	1x1
FirmwareRevision	e.g., 91 as in 3.91	1x1
Frequency	Frequencies available for the system	3x1
InstrumentMatrix_0	Instrument matrix for the 3 MHz velocity beams in an M9 or S5	15x1
InstrumentMatrix_1	Instrument matrix for the M9 500 KHz vertical beam or the S5 1 MHz vertical beam	15x1
InstrumentMatrix_2	Instrument matrix for the M9 1 MHz velocity beams	15x1

Appendix D. Troubleshooting

1. Communications

- a. PCM (Power and Communications Module)
 - a) Be sure the dummy plug is installed, and the locking sleeve is secured
 - b) Be sure the battery pack in the PCM is fully charged
 - c) Bluetooth Radios
 1. Bluetooth communications (BT) PCMs are always active and have an internal antenna. Make sure BT communications are active in the Mobile device or the PC.
 2. The Bluetooth dongle requires power from a PC USB port
 - d) Spread Spectrum (SS) Radios
 1. The SS base radio requires a rechargeable battery pack. Be sure the battery pack is fully charged.
- b. Software
 - a) If the COM port shows a red light instead of green, then it is being occupied by another program. The most common cause is Microsoft ActiveSync. Disable the program. If the red light doesn't turn green, restart the computer.

2. Interconnection and cables

- a. Please be sure to follow assembly instructions to interconnect correctly to maintain secure connections.
- b. Make sure that all cables are properly connected. The connections between the transducer (S5 or M9) and PCM should be firm. Make certain that the locking sleeves are tightened.









3. Data Collection





- a. The Status Bar in the *RiverSurveyor Live* software is a good place to start to diagnose any potential problems. Here is a list of the icons and description as well as a suggested corrective action.

- a)  Bluetooth in the system is not activated. Activate in the Mobile device as indicated above and be sure that antenna is installed properly.

- b)  Bottom track is not functioning. Please check cable connection between the PCM and S5 or M9 ADP. Also check that the transducers are clean and unobstructed. Some environmental conditions (such as bed conditions or grass/weeds) may also result in invalid bottom detection.

- c)  RTK quality GPGGA data (accurate to 3 cm or less). No action required by the user. Important Note: After powering on both systems (RTK Base Station and RiverSurveyor) it typically takes approximately 10 minutes to connect to the system to achieve this quality of data.

- d)  Differential quality GPGGA data (sub meter accuracy). It usually takes approximately 5 minutes to connect to this level of quality of data. No action required by user unless RTK quality is required. Be sure that the systems (Base Station and RiverSurveyor) have clear sky view antenna and that SS connections are correct.
- e)  Indicates that communications have been established between the system and satellites, however there is no sub-meter differential correction. It is generally not recommended for discharge calculations. Users should make sure that they have a clear sky view. Time needed to establish a connection between System and Satellites: 5 minutes for Differential quality data or up to 10 minutes for RTK quality data.
- f)  and/or  Connection not valid. Action required: Revise all cable connections and be sure to have a clear sky view for antenna. Be sure that the battery pack is sufficiently charged.
- g)  and/or  GPS not available or not installed. If you are using an external, serially connected GPS, make sure that you have the correct baud rate (38400) and the \$GPGGA and the \$GPVTG serial data strings are being output from your GPS unit.
- h)  GPVTG data (highest quality VTG data—measured velocity data). It typically takes approximately 5 minutes to connect. No action is required as this is the highest level of VTG data available. To maintain this level of data quality, make certain that RiverSurveyor have clear sky view. At least 6-7 satellites are required for reliable VTG data. Satellite changes can affect track data and should be monitored during data collection. Like differentially corrected (not RTK) GGA data, VTG data are best suited to streams greater than 20 meters across. The best VTG data are obtained when the vessel motion is constant. Additional transects may be advisable if VTG accuracy is in question during a discharge measurement.
- i)  Mean Bottom Track depth is used for depth calculation.
- j)  Vertical Beam depth is used for depth calculation.

- k)  No depth-lock for either the Bottom Track or Vertical Beam. Some environmental conditions (such as bed conditions or grass/weeds) may also result in invalid depth detection.
- l)  Bottom Track not available or not installed.
- m)  Battery level in the system is at 10%. Finish data collection immediately or risk losing data. Communications will have to be re-established after installing a re-charged battery pack.
- n)  The data collection device (PC or Mobile device) is not receiving data. This does not mean that the system is not collecting data. The system will continue to collect data even if the communications link is lost. If using a wireless link such as Bluetooth (range is 60 m) or Spread Spectrum radios (range is 2 km), the system may be out of range or there may be obstacles preventing communication. Always aim to maintain direct line of sight between the system and communications device. For direct connection, most likely the cable has been disconnected.

4. Multiple discharge calculations across the same transect do not match

- a. Flow conditions may have changed since you completed the last transect. This may be the case in areas of high tidal variation or when the measurement section is downstream of a man-made structure that regularly alters the flow conditions. Constant stage or water level is not a clear indication the flow conditions have been maintained.
- b. Be sure to keep a written record of water level at the site during the discharge measurement. The water level can be referenced to a stream gauge that is permanently installed or to a staff that can be temporarily installed on the water's edge.
- c. Make sure the site depth and location that you measured for the first transect match the measured values for the second transect in the data collected. You may have moved up or downstream since the last transect.
- d. Visible landmarks are always a good guide when making a measurement. Check the positional and depth measurements for both transects.
- e. Make sure the distance made good (DMG) is consistent between transects.
- f. The acceptable error between two to four measurements is typically less than 2 to 5% but may be potentially higher depending on your application and the conditions.
- g. The edge positions should be the same or very close. Therefore, the edge distances should be the same or similar for all transects.

5. Bottom Track

- a. If bottom track is lost or becomes intermittent during data collection, be sure the water depth is within the measureable range of the M9/S5.
- b. Sudden changes in heading, pitch and roll can affect bottom track performance.
- c. It is best to keep the boat at, or below, the speed of the water when practical. However, that can be difficult to do in very slow, low flow environments.
- d. Bad bottom track samples can be removed in Post Processing with the following steps:
 - a) Click on the Samples tab in the lower left corner of the screen.
 - b) Right-click in the column headers section to select Debug and then check Use.
 - c) The "Use" column will appear for each sample.

If the “Use” box is unchecked for a sample, the bottom track velocity for that sample is substituted with the bottom track velocity of the previous sample. This functionality works only for 9 consecutive samples. The bottom track velocity for a deselected sample is not averaged or interpolated. This functionality works only if BT is selected as a reference and not for GGA or VTG.

In the example below, you can see the slight difference before and after the bottom track filter is applied in the center of the transect.

Before BT filter:

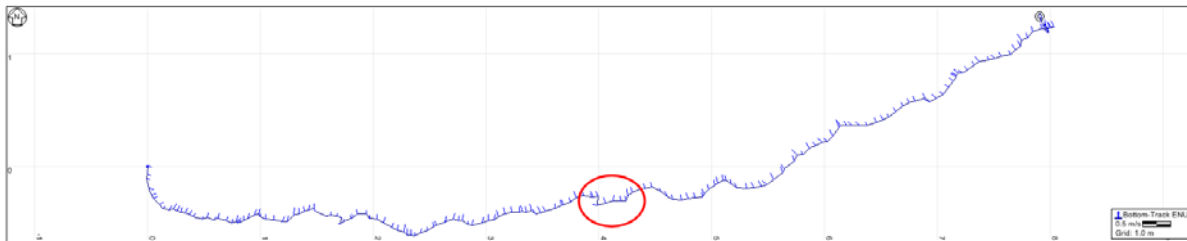

After BT filter:

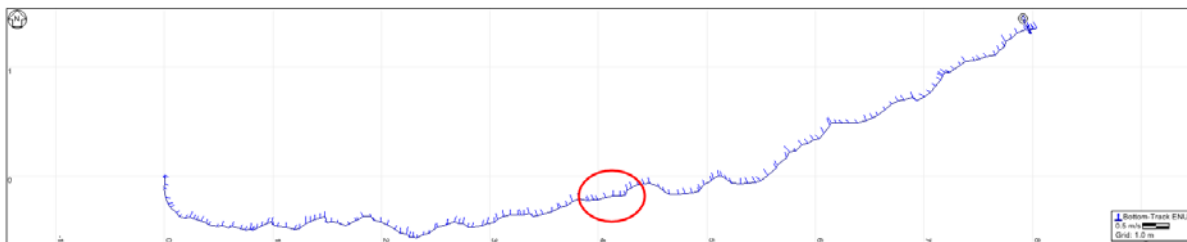

6. GPS

- a. Be sure the GPS antenna(s) have a clear view to the sky. Large trees or structures like bridges and buildings nearby can obstruct the satellite signals. Move away from any over-head obstructions to avoid multi-path errors or GPS dropouts.
- b. The GPS antenna on the ADP should be connected to the PCM with the coaxial cable.
- c. GPS Quality
 - a) Zero is no GPS fix
 - b) One is a non-differential GPS fix
 - c) Two is a differential GPS (DGPS) fix
 - d) Four is an RTK fixed integer condition. This is the best option. It indicates that both GPS receivers are locked on the same satellites.
 - e) Five is an RTK float integer condition. This indicates a “float” condition where the data quality is between the SonTek DGPS and SonTek RTK because both GPS receivers are not locked on the exact same satellites. It is expected that this condition, if present, will be temporary (could last several minutes, but generally less than one hour) as the GPS receiver will eventually lock on either the DGPS or the RTK and will not remain in this “float” condition too long.
- d. GPS HDOP
 - a) Horizontal Dilution of Precision is a GPS term used to describe the geometric strength of satellite configuration on GPS accuracy.
 - b) Table 8 describes the possible values

Table 8: HDOP Value Descriptions

























HDOP Value	Rating	Description
1	Ideal	This is the highest possible confidence level to be used for applications demanding the highest possible precision at all times.
2-3	Excellent	At this confidence level, positional measurements are considered accurate enough to meet all but the most sensitive applications.
4-6	Good	Represents a level that marks the minimum appropriate for making a good-quality discharge measurement. Positional measurements could be used to make reliable in-route navigation suggestions to the user.
7-8	Moderate	Positional measurements could be used for calculations, but the fix quality could still be improved. A more open view of the sky is recommended.
9-20	Fair	Represents a low confidence level. Positional measurements should be discarded or used only to indicate a very rough estimate of the current location.
21-50	Poor	At this level, measurements are inaccurate by as much as 300 meters with a 6-meter accurate device (50 DOP x 6 meters) and should be discarded.





























e. RTK

- a) Be sure the SS antenna is connected to the RTK Base Station
- b) Be sure the battery pack in the RTK Base Station is fully charged
- c) Be sure the RTK Base Station is within the 1-mile range limit of the ADP
- d) The GPS antennas should be mounted to the RTK Base Station and ADP.
- e) Connect time for Differential Quality GPS data is approximately 5 minutes
- f) Connect time for RTK quality GPS data is approximately 10 minutes
- g) Use the status icons to evaluate GPS (RTK and DGPS) Communications Quality. The tables below provide a quick reference for the software status icons and the LEDs on the PCM and RTK Base Station.

IMPORTANT NOTE: This section describes only the First-Generation Power and Communications Modules (PCM). For information on SonTek's Second General PCM, including LED patterns, please see **Appendix J**.

Before RTK Lock:

Scenario	Base Station		PCM		Software Indicator for PCM			Status	Action
	GPS Lock LED	RTK Lock LED	GPS Lock LED	RTK Lock LED	GPS Quality	GPGGA Icon	GPVTG Icon		
Hardware failure in Base Station and PCM					0			No power to GPS board in both PCM and Base Station	Send back both the power/comm. boxes to the factory
BS hardware failure and no GPS in PCM					0			No power to GPS board in Base Station	Send back RTK Base Station to the factory
No Base Station lock and hardware failure in PCM					0			No power to GPS board in PCM	Send back PCM to the factory
No GPS lock in Base Station and PCM					0			No clear view of the sky for Base Station GPS antenna. Using a PCM prior to this software release will also display red while acquiring RTK lock	Ensure Base Station GPS antenna has clear view of the sky

GPS lock in Base Station but no DGPS lock					0			No clear view of the sky for Base Station GPS antenna	Make sure Base Station GPS antenna has clear view of the sky to get DGPS lock
No GPS lock in PCM					0			No clear view of the sky for PCM GPS antenna	Make sure PCM GPS antenna has clear view of the sky to get GPS lock
GPS lock in PCM but no differential lock					1			GPS antenna of the PCM may be near a bridge or some obstruction	Move away from the bridge or a structure to get full view of all the available satellites to get differential lock
GPS lock in PCM and no radio link between Base Station and PCM					1			Spread Spectrum radios in PCM and RTK Base Station are not working	Send back PCM and RTK Base Station to the factory
GPS lock in PCM with differential lock				Flashing Green	2			GPS antenna of the PCM may be near a bridge or some obstruction	Move away from the bridge or a structure to get full view of all the available satellites to get RTK lock

GPS lock in PCM while acquiring RTK lock					5			RTK, float integer (between RTK and DGPS)	
GPS lock in PCM with RTK lock					4			RTK, fixed integer (best option)	

Appendix E. Software Changes

RiverSurveyor Live v1.50

1. Multi-Language Support

RiverSurveyor Live software has full language and date/time/numerical support for the following languages:

- English
- Spanish
- Catalan
- Chinese (Simplified)
- French
- German
- Italian
- Korean
- Japanese
- Portuguese (Brazil)
- Turkish
- Hungarian

The currently selected language is displayed in the toolbar at the top left on the main screen as an icon representing the flag for the language. The language can be changed at any time in the software by clicking on the flag and selecting the desired language from the drop-down list. All text, dates, times and numbers are displayed in the current language. **This means that numerical input must correspond with the language.** For example: The number **1,000.1** when English is selected, must be input as **1.000,1** when German is selected.

The Summary Report and ASCII export have Multi-Language support.

All log files (Compass Calibration, System Test) are recorded in English for troubleshooting purposes.

2. All Graphs

All graphs can be saved to the clipboard by right clicking on the graph and selecting **Save to Clipboard** from the popup menu.

3. Time Series Window

The Time Series Window displays multi-parameter parameters such as individual Bottom-Track Beam Depths. Additional parameters can be displayed including:

- GC-BC
- Bottom-Track beam Depths

A space on either side of the Time Series Window has been added to illustrate that edges are present.

4. Track Window

The Track Window now only displays Tracks that are practical for the current coordinate system. For example, GPS-GGA and GPS-VTG cannot be displayed in XYZ or System coordinates.

Track Window settings are now global (i.e. a change to the setting on one graph affects ALL Track Windows). Settings include:

- AutoScale
- AutoRotate
- Show Velocity Vectors
- UTM Display
- Tracks

When a GIS Map is loaded, right clicking on the Track Window displays the popup menu with a GIS sub-menu. On this menu are the following options:

- Zoom to Full Extents – Zooms out to display both the full map and all data
- Zoom to GIS Map – Zooms to the limits of the full map
- Zoom to Data – Zooms to the limits of all the data

5. **Contour Window**

The Contour Window displays a tooltip for highlighted cells.

A space on either side of the Contour Window has been added to illustrate that edges are present.

6. **Profile Window**

When displaying Discharge in the Profile Window, the profile extrapolation extends to the bottom.

7. **All Tables/Tabular Data**

All tabular data can be saved to the clipboard by right clicking on the table and selecting **Save to Clipboard** from the popup menu. This data can then be pasted into Excel or a text editor for ASCII export.

The order of the columns can be changed and is saved in the application settings. The columns should be adjusted to match the user display preferences or requirements for ASCII export.

Columns support multi-dimensional parameters (e.g. individual Bottom-Track Beam Depths).

8. **System Tab**

Column selections have been updated.

9. **Edges tab**

The **Edges** tab displays the **Left Bank** and **Right Bank** instead of the **Start Edge** and **End Edge**.

10. **Times Series Tab**

A new tab titled **Time Series** has been added that displays five multi-parameter Time Series windows.

11. **Discharge Measurement Summary**

Active Records (records that are checked) that have discharge values that are outside of +/- 5% of the mean discharge are now displayed in red.

This feature can be enabled/disabled using the **Highlight Records** button on the Discharge Summary toolbar.

The icons for the Start Edge - Left Bank and Right Bank have been swapped. The arrows now point in the direction of travel across the river.

The splitter for the Discharge Measurement Summary has been repositioned to display 6 measurements plus statistics by default.

The Summary only displays data for completed transects.

Export to .dis from discharge summary table includes Start Date.

12. **Site Information**

Site Information can be edited/changed in post-processing and all changes saved to the workspace. Any modified values are displayed in green text – just like all other fields. Note: In some cases, fields that have not been changed are displayed in green. This is because the original Site Information fields may have been initialized incorrectly.

13. **Lock Measurements**

Individual measurements can now be locked. This means that once a measurement is locked by pressing the **Lock Measurement** button on the **Processing Toolbox** toolbar any changes to the settings will not be saved to the workspace. A measurement can be unlocked by pressing the **Lock Measurement** button a second time.

14. **Processing Tools**

Heading Correction added to the **Thresholds** tool. This setting should be used for corrections to the Heading for individual transects. The **Magnetic Declination** should be constant for all transects at a site and the **Apply to All** button can be used for all transects without affecting individual heading corrections.

Composite Tracks option added to the **Thresholds** tool. This setting by default is ON, in both software and firmware. When disabled the track is calculated only using the selected reference and not a combination of the best possible references.

15. **System Test**

System Test is logged to a text file.

16. **MATLAB Export**

Bottom-Track Velocity label is output as BT_Vel (previously Bt_Vel).

Units are removed from the names and are stored in a separate substructure within each of the root structures.

17. **Loading Data File**

Data files are loaded in chronological order.

18. **Increased Precision on ALL Parameters**

The precision has been increased (from float to double) on all values used in the software. Float has a precision of about 6 digits and doubles have 15. This means that the previous version may have done some rounding when dealing with large numbers of samples. The most observable difference between 1.00 and 1.50 could potentially be in the third or more significant digit of the discharge, but in most cases the variation would be extremely small.

RiverSurveyor Live Mobile v1.50

1. Multi-Language Support

RiverSurveyor Live software has full language and date/time/numerical support for the following languages:

- English
- Spanish
- Catalan
- Chinese (Simplified)
- French
- German
- Italian
- Korean
- Japanese
- Portuguese (Brazil)
- Turkish
- Hungarian

Following are the steps to select a language:

1. When you run this version of the software for the very first time, the following language selection dialog will open before searching for any RiverSurveyor systems.

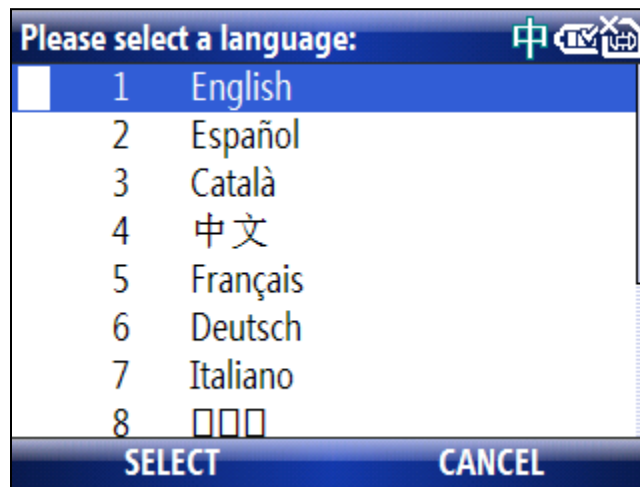

2. Select a language and click "SELECT" button.
3. The software will start searching for Bluetooth RS systems and it will operate just as v1.00.
4. If you close this application and start it again, the software will automatically start in the language selected.
5. If you would like to change the language again, click "Utilities" on main menu and click "Application Settings". The following dialog will open:

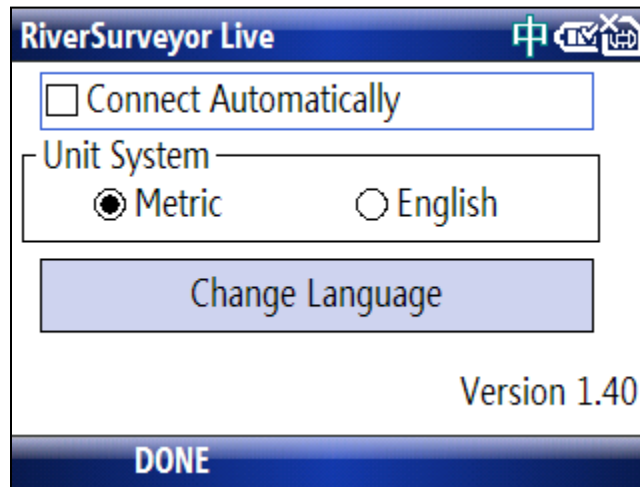

6. Click the “Change Language” button and it will take you to the language selection dialog.
7. Unlike the RiverSurveyor Live PC software, you can only change languages from “Application Settings” dialog.
8. To change decimal and thousand separators to a particular locale in the software application, you have to change locale manually in the phone. You can do this by going to /Settings/Regional Settings/Locale.

To display Chinese, Japanese and Korean fonts:

9. Windows mobile doesn’t have built-in support for Chinese, Japanese or Korean font.
10. Third party software called “CE-Star for SP” is available online to display Chinese, Japanese and Korean characters.

All log files (Compass Calibration, System Test) are recorded in English.

2. Mobile Graphics

One main addition in this version is mobile graphics in moving boat dialog. Measurement procedure is same but hotkeys 1, 2, 3 and 4 do not work to show different tabular views. To view different tabular and graphical views in moving boat dialog, follow the steps below:

1. Use up and down arrow keys to scroll between following views:
 - a. Tabular
 - b. Graphical
2. Use right and left arrow keys to scroll between pages in each view:
 - a. Tabular – 4 Pages
 - b. Graphical – 4 Pages (time series, profile, track and contour plots)

3. Summary Table

Hotkeys 1, 2, 3 and 4 do not work to show different tabular summary options. To view different summary options in summary view, use right and left arrow keys to scroll between summary options.

RiverSurveyor Live v2.50

RiverSurveyor Stationary Live v1.50

1. **Data Storage**

- Data files are saved to the computer as well as the M9/S5 recorder. This eliminates the need to download files to process them if communications are not lost during a measurement. Files saved on the computer are appended with the letter 'r', i.e. *r.rivr.
- The system serial number is embedded in the compass calibration and system test file.

2. **Temperature and Speed of Sound Correction**

Water temperature and speed of sound can be manually input prior to a measurement and in post-processing.

3. **Data Display**

- Beam frequency added to the SNR profile plot

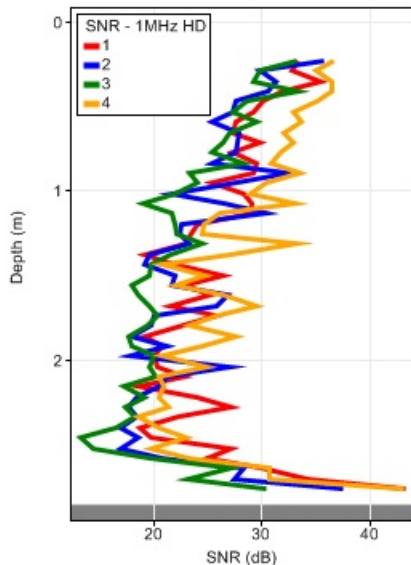

- The following variables can be plotted on the Time Series tab and displayed in the Samples tab:

Track Reference Code - 3 MHz, 1 MHz, GGA, VTG or invalid

Depth Reference Code - VB, 3 MHz, 1 MHz or invalid

Water Profiling Code - 3 MHz PC, 3 MHz IC, 1 MHz PC or 1 MHz IC

4. **Lock Measurement**

A transect that is locked remains displayed as locked after the file is closed and reopened.

5. **Discharge Summary Report**

- Water temperature, compass calibration, system test and moving bed test results are displayed.
- Comments for each transect are displayed.
- A change in the Site Information is updated properly.
- Measurement number is included.
- *Date Created* is replaced with *Measurement Date*.
- A locked transect is displayed as such.

RiverSurveyor Mobile v2.50

RiverSurveyor Stationary Mobile v1.00

1. **Data Storage**

- Data files are saved to the mobile device as long as a memory card is installed. This eliminates the need to download files to process them if communications are not lost during a measurement. Files saved on the computer are appended with the letter 'r', i.e. *.r.rivr.
- The system serial number is embedded in the compass calibration and system test file.

2. **Temperature and Speed of Sound Correction**

Water temperature and speed of sound can be manually input prior to a measurement and in post-processing.

RiverSurveyor Live v2.50

RiverSurveyor Mobile v2.50

1. **Loop Method**

A USGS developed method to correct moving-boat discharge measurements using bottom-tracking is integrated in the software. See Appendix H for details.

RiverSurveyor Live v3.00

RiverSurveyor Mobile v3.00

1. Smart Page Setup

This feature provides a step by step guide through the system setup with real-time feedback to collect the most reliable discharge measurements. System functional test results (such as a compass calibration) as well as system settings are stored in the data file for easier access in post-processing. The initial screen after connecting now displays red or green icons depending on the status of system functional test and system settings.

There is also an option to turn off/on the Composite Tracks feature. This setting by default is ON, in both software and firmware. When disabled the track is calculated only using the selected reference and not a combination of the best possible references.

2. GPS Compass Integration

A GPS Compass is a device that uses GPS signals to provide heading information. Unlike a regular GPS receiver, a GPS Compass can provide very accurate headings even when stationary. GPS Compasses provide two great advantages when compared to a regular magnetic compass:

- Because they rely on GPS signals, rather than the earth's magnetic field, they point to true north (not magnetic north)
- They are not affected by ferrous materials or other magnetic interferences in the vicinity of the sensor

GPS Compasses also have the benefit of being a great positioning device as well, as they are, after all, a DGPS in the first place.

SonTek has integrated a powerful yet practical, commercially available GPS Compass from Hemisphere. The model integrated is the V102, which provides a heading accuracy of < 0.75° RMS, and a position accuracy < 1.0 m. As of the writing of this manual, SonTek has not evaluated the integration of other GPS Compass systems.

In order to use the V102 GPS Compass with your RiverSurveyor M9/S5, you must purchase a firmware unlocking code from SonTek that will enable your M9/S5 to receive the heading and position data.

In addition to true-north heading information, the GPS compass simultaneously outputs GPGLA (differential using SBAS) and GPVTG NMEA data strings, which are used by the M9/S5 to compute position and boat-speed. In addition, the firmware and software let you input the X and Y distance between the GPS antenna and the M9/S5. This allows the GPS compass antenna to be mounted virtually anywhere on the boat.

If you already own a V102 GPS Compass AND you performed your measurements from a manned boat setup (such that the computer is in the boat with the M9/S5), then all you need to operate it with your M9/S5 is the unlocking code described above and the direct connection cable provided by Hemisphere with your V102 (this cable is connected into a secondary Serial Port on your computer). The instructions for configuring the V102 GPS compass are:

- a) Fully set up the M9 with GPS compass and all batteries and cables properly installed.
- b) Connect to the M9 using the Utilities software.
- c) Open the terminal emulator from within the Utilities software

d) Type the following command to start communicating with the GPS compass:
ECHO<space>3,<space>19200

If there is no response to the above, then try: ECHO<space>3,<space>38400

e) Now you should see GPS strings being output. You should see GPGGA, GPVTG, and HEHDT strings being output. If not, the GPS needs to be configured to output these strings at the proper baud rate, with other strings disabled.

f) In order to suspend GPS output, type the command \$JOFF

g) In order to set the baud rate for communications with RSL and HS, type the command:
\$JBAUD,38400

h) Type the proper commands from Hemisphere (usually starting with "\$") to configure the GPS.

\$JASC,GPGGA,10 This will turn the GGA message on at a10 Hz rate

\$JASC,GPVTG,10 This will turn the VTG message on at a 10 Hz rate

\$JASC,GPHDT,10 This will turn the HDT message on at a 10 Hz rate

\$JATT,NMEAHE,10 This will preface HDT message with HE instead of GP

\$JSAVE This will save the settings

i) In order to disconnect from the GPS, hit the ESC key on your keyboard.

j) Now you are back in normal terminal mode, talking to the M9. If you don't need to utilize any other Utilities functions, simply exit the software.

k) Connect to the M9 using the RSL software. Run through the SmartPage and make sure GPS compass heading is enabled, and other GPS options are set (e.g. GPS Option is DIFF).

l) After you start a measurement, heading information should populate the fields in the tabular display, and the heading source should show GPS compass. Satellites, HDOP, and other GPS parameters fields should also be populated with numbers (not just zeroes).

Summary of Commands:

ECHO 3, 19200 Establish communications with the GPS using the default baud rate

ECHO 3, 38400 Establish communications with the GPS using the RSL and HS baud rate

\$JOFF Turn off any messages that are currently turned on

\$JBAUD,38400 Set the baud rate from the default (19200) to 38400

\$JASC,GPGGA,10 Turn the GGA message on at a10 Hz rate

\$JASC,GPVTG,10 Turn the VTG message on at a 10 Hz rate

\$JASC,GPHDT,10 Turn the HDT message on at a 10 Hz rate

\$JATT,NMEAHE,10 Preface HDT message with HE instead of GP

\$JSAVE This will save the settings

Once connected, the RiverSurveyor Live and HydroSurveyor software will send the appropriate commands to connect to and interpret the V102 data.

If you operate your RiverSurveyor M9/S5 system by using any one of SonTek's Power & Communications Modules (PCMs), then you will need a splitter cable that combines the data from the M9/S5 with the V102 so that it can be transferred over the computer together through the PCM. SonTek can supply both the V102 and the splitter cable, or just the splitter cable if you already own a V102 GPS Compass.

3. **USGS SMBA Method**

The SMBA-method correction is used when a moving-bed is present and a DGPS or compass is not available or reliable. The calculations are all based on the "Algorithms Used in SMBA" by David S. Mueller and USGS calculations and procedures documented in the USGS "Scientific Investigations Report 2006-5079" by Mueller and Wagner. The USGS recommends a moving-bed test prior to the start of any discharge measurement and the SMBA method is routinely used to identify the magnitude of the moving-bed. The RiverSurveyor software now guides you step by step through this procedure, and then allows you to apply the correction to the appropriate discharge measurements without having to export data to the USGS SMBA program. This saves time and effort in the field and in the office whenever you use this procedure.

4. **Additional Profile Extrapolation Methods**

This version of the firmware supports one additional top and bottom extrapolation method. The top methods are Constant, Power, and 3-point slope; the bottom methods are Constant, Power, and No Slip. The new 3-point slope method for top extrapolation uses the top three cells to calculate a best-fit line (least squares regression); this slope is then applied from the top cell to the water surface. The new No Slip method for bottom extrapolation uses the cells available in the lower 20% of the water depth to determine a power-fit forcing it through zero at the bed. In addition, this allows you to input the percentage of lower cells to calculate power-fit.

RiverSurveyor Live v3.00

RiverSurveyor Stationary Live v2.00

1. **ASCII Export**

The Processing Toolbox includes the ability to export three ASCII comma delimited files (.vel, .sum and .snr). These files contain cell velocity data, cell SNR data and summary of various parameters. The files are exported to the same directory as the recorded measurement file. The column headers and units are listed at the top of the CSV files.

2. **CastAway CTD Integration**

The CastAway CTD is a sophisticated CTD that makes it simple to improve the accuracy of RiverSurveyor discharge measurements by integrating seamlessly with the RiverSurveyor Live software. This new feature provides a turnkey solution for applying sound speed correction to ADCP data. The built in GPS in CastAway CTD marks the location and timestamp of the sound speed profile and allows the software to automatically select which sound speed profile to use for your discharge calculation. The software displays the CTD profile data and the location of CTD cast on the ship track plot.

See Appendix I. [CastAway CTD Integration](#) for further information.

RiverSurveyor Live v3.50

1. **Improved Compass Calibration Feedback**

The compass calibration feedback for the new SonTek compass (v2.00 or later) is improved. The compass calibration dialog includes a time series chart and graphical interface to guide the user to perform the best possible compass calibration. See Section 6.11.1 for details about the G3 Compass Calibration.

2. **Modified Algorithm for USGS Loop Method**

The USGS Loop Method was updated to support the latest algorithms (MATLAB v4.03) from the USGS Office of Surface Water (OSW). New error messages and warnings are implemented to collect and analyze loop method data correctly. See Appendix H for details about the Loop Method.

RiverSurveyor Stationary Live v2.50

1. **Under Ice Measurement Feature**

This feature lets you collect and analyze a stationary measurement under ice.

2. **Profile extrapolation (Station by Station)**

1. Ability to change profile extrapolation for each station.
2. Following extrapolation methods are available for bottom fit:
 - a. Power fit
 - b. Constant
 - c. No Slip
3. Following extrapolation methods are available for top fit:
 - a. Power fit
 - b. Constant
 - c. 3 point slope (open water) and No Slip (under ice)
4. Ability to apply profile extrapolation to all stations globally
5. Default profile extrapolation for top fit and bottom fit
 - a. Open water – power fit for entire profile
 - b. Ice or Ice/Slush – No Slip with 20%

3. **Pre-Deployment Template**

1. Ability to create station template from start page
2. Ability to save station template from start page
3. Ability to save station template from already collected data file

4. Ability to retrieve station template and use it for data collection

4. **Additional Features**

1. New layout of plots in transect tab
2. Added time series tab
3. Added ability to input transducer depth below ice for each station
4. Re-organized station dialog to help the application flow for ice measurement
5. Ability to access station dialog from contour plot
6. Added %Q time series graph in transect tab with % as text
7. Added water temperature (Independent) to the quality settings dialog
8. Added instrument alignment parameter to help the user to align the M9/S5 properly under ice
9. Added functionality to open/save site information
10. Increased number of characters to 250 for comments in Site information.

RiverSurveyor Live v3.60

1. Increased significant figures (3) for section area, mean velocity, mean gauge height (user input) and discharge, Included in the Discharge Summary Report.
2. Added maximum speed and maximum depth to Discharge Summary Report and ASCII output (.dis). It is the maximum for the set of open transects.
3. Support of new Hemisphere GPS firmware. There are now 5 GGA Quality Indicators instead of 4: 0 (no fix), 1 (basic GPS fix; not appropriate for discharge measurements), 2 (DGPS fix), 4 (RTK quality), 5 (RTK Float; this is the new value added and represents a step *between* DGPS quality and RTK quality).

RiverSurveyor Stationary Live v2.60

1. Updated the exported ASCII *.vel file with the normalized velocity rather than the measured velocity.

RiverSurveyor Live v3.70 and RiverSurveyor Stationary Live v3.70

1. Added support for Second Generation PCMs, including:
 - Flexible battery options
 - User pairing capability
 - SonTek-developed multiplexing radio with optimized antenna positions capability
 - External “Bridge” device for variable/future mobile support
 - Completely waterproof design (rated IP 67).
 - See Appendix J for more details on the new PCMs.

RiverSurveyor Live v3.80 and RiverSurveyor Stationary Live v3.80

1. **Added SonTek File Manager**
 SonTek File Manager (SFM) – Opens a dialog box that enables users to search a specified directory of .riv/.rivr files over a user specified date range and fields such as: serial number, site name, operator etc.
2. **Added SonTek File compression tool**
 Compresses open RSL *.riv/*.rivr files including loop, SMBA, compass cal, system test files, work space files (*.wsp) and exported Matlab (*.mat) files into a directory chosen by the user.. Enables users to save a set of files they have post-processed, preserving edits by copying *.wsp files, together in a *.zip file that they can name and in a directory that they specify.
3. **Support for the new G3 compass**
 - New compass calibration display - Outputs: Error from calibration (deg) and Mean Magnitude (of the ambient magnetic field)
 - Compass alerts – compass pitch and roll alerts displayed in a counter for samples where magnetic error >3.5% from the error from calibration score and for when pitch and/or roll is greater than range that was covered during compass calibration.
 - Added the ability to plot a time series of magnetic error, output by the magnetometer, in real-time and post-processing.
 - Added markers on time-series for samples where compass alerts were raised.
4. **Improved the color map display**
 Added grey line below the last good cell, white for unmeasured area and black line to delineate the bottom
5. **Auto-connect robustness improved across all connection options**
 Auto-connect option now scans and recognizes instruments connected via PCM1, PCM2 and direct connect more quickly.
6. **Added manual connect option**
 Manual connect option added to the connection dialog box. If the RSL system is not found automatically by the auto-connect option, the user now has the option to select a COM port and connect.
7. **Added option for USGS default screening distance**
 A text file that will be supplied to USGS and others who desire this option can be used to set a default screening distance. When present the text file is read by RSL and the default screening distance will be added to the transducer depth. A popup will alert the user that this screening distance is being applied. The screening distance can be changed by the user in the text file.

8. Additional MATLAB output

Transmit length and blanking distance added to output.

9. Added instrument serial number to compass calibration file

Serial number added to the compass calibration file.

10. Added option for USGS default screening distance

A text file that will be supplied to USGS and others who desire this option can be used to set a default screening distance. When present the text file is read by RSL and the default screening distance will be added to the transducer depth. A popup will alert the user that this screening distance is being applied. The screening distance can be changed by the user in the text file.

11. Added Russian Language

Russian language added per customer request.

12. Bug fix – F5 functionality

F5 functionality now the same as clicking buttons in the Graphical User Interface.

13. Bug fix – ASCII export file name corrected

ASCII exported file names now match the source *.riv/*.rivr filename.

RiverSurveyor Live v3.81 and RiverSurveyor Stationary Live v3.81

1. Support for tablet software.
2. MATLAB export structures updated to support new compass data structure.

RiverSurveyor Live v3.91 and RiverSurveyor Stationary Live v3.91

1. USGS screening distance option during software installation
2. Improved auto and manual connection options
3. Firmware version verification upon connection
4. Exported *.mat files included in the Compress File Utility

RiverSurveyor Live v3.9.50 and RiverSurveyor Stationary Live v3.9.50

1. **Start and end Gauge Height added to discharge summary report:** Summary now records the start gauge height from the first file and end gauge height from the last file, if multiple files are open
2. **RSSI Base:** RSSI Base information added to time series data
3. **Compass Alert:** Compass alert information is now available in both the real-time and post-processing in the RSSL software
4. **Language:** Updated Multi-Language
5. **System Check:** Added another check to verify, if the M9 compass used for the data collection is G3/G2 compass

6. **Extrapolation:** Removed constant as one of the options for the bottom extrapolation method in RSL and RSSL software. Bug fix, bottom extrapolation method set to “No Slip” sometimes results in missing area and discharge data.
7. **SmartPage:** SmartPage or system tab window does not scroll back to the top after the parameters are entered/modified
8. **Compass:** Fixed “Compass Not Responding” bug in the G3 compass calibration
9. **Software Version:** Show software version that is used to collect a measurement in the system tab under system configuration (both RSL and RSSL)
10. **Compass Calibration:** Added compass calibration information that is displayed on the SmartPage at the end of *.ccal file. Green check mark on SmartPage only if the compass calibration passed. G2 compass calibration results now displayed correctly on SmartPage.
11. **Composite Tracks:** Changed the composite tracks default to OFF. The user has the option to switch it ON
12. **Post Processing:** Included compass alerts and RSSI Base information in Post Processing
13. **Discharge Summary:** Implemented the original functionality to delete selected record(s) in the discharge summary tab
14. **Zip File:** Changed default compressed file folder location to the folder containing the data that are opened in the software (both RSL and RSSL)
15. **Radio Button:** Added a radio button for direct connect in the manual connection dialog both in RSL and RSSL software
16. **GPS:** Fixed bug when switching SonTek GPS option between RTK and DGPS. Also, ensured GPS application correctly displayed
17. **Lock measurement/Moving Bed Correction bug fix:** Previously if a measurement was corrected using a stationary or loop moving bed test and the appropriate track reference (LC, SMBA) selected and applied and the measurement is subsequently locked and closed, when the measurement is reopened the LC or SMBA setting is not retained and the track reference shows only BT. This means that when someone opens a "locked" measurement the discharge will be different than that originally computed.
18. **Processing Toolbox:** Changing anything in the Processing Toolbox that is not on the system settings screen then clicking Apply doesn't affect the corrected discharge. Bug fixed.
19. **Serial Connection:** Improved serial connection functionality
20. **Compass Alert:** Mouse hover information on the compass alert indicator works only for the first file/session. Fixed this bug and mouse hover works correctly for all the files/sessions. Previously the compass alert indicator worked fine until "CTRL + S" was pressed to look at the summary information. Bug fixed and the compass alert indicator always displays properly regardless of the user input/control.
21. **Matlab:**
 - Added automatic Matlab export option in the RSL software
 - i). Added user selectable option under program settings to enable/disable automatic matlab export
 - ii). In the real time, a Matlab file will be created once a transect is completed
 - iii). In post-processing, a Matlab file will be created when a measurement file is either closed or locked

iv). File is exported to the folder location where the measurement file is stored.

v). If there are missing samples in a transect, then the software will not automatically create a Matlab export after a transect is completed.

- Added final "Area" to Matlab export, Summary structure
- Included "Site Information" in the Matlab export (both RSL and RSSL)
- Removed spaces and special characters from the "SiteInfo Matlab structure" variable names and replaced with "_"
- Fixed GPS.Utc data structure in the Matlab export. The GPS.Utc structure now shows correct data and it matches with other data structures under the GPS structure.
- Matlab files that are exported using RSL v3.9.0 are corrupted. Removed min and max pitch and roll from Pitch and Roll Structure. Now records a single value for min and max pitch and roll in the compass structure

RiverSurveyor Live v4.0 and RiverSurveyor Stationary Live v4.0

1. Real-time Quality Control feature added
2. Manual Configuration option added
3. RSSL GPS Option added
4. Program Settings options updated

RiverSurveyor Live v4.1 and RiverSurveyor Stationary Live v4.1

1. Bottom Track debug filter added.
2. Maximum salinity input changed from 35 ppt to 45 ppt.
3. USGS screening distance disabled for an S5.
4. Disabled auto-export to Matlab if there are any missed samples in a data file.
5. Fixed Matlab export of large .riv and .rivr files.

RiverSurveyor Live v4.2 and RiverSurveyor Stationary Live v4.2

1. Automatic DGPS/RTK Switching with new PCM model number PCM-I-13 or higher.

Appendix F. SmartPulse^{HD}™ Principles

SmartPulse^{HD}™ is name chosen for the new profiling capabilities of the RiverSurveyor M9 and S5. In general terms, it works as follows:

- The RiverSurveyor continuously tracks water velocity and depth. Based upon these values, it selects the optimum processing configuration.
- At any given time, the system is sending multiple pulse types, potentially at multiple frequencies, using different processing techniques to achieve the optimum system performance.
- For the M9, up to three frequencies are used (3 MHz, 1 MHz, 0.5 MHz); for the S5, up to two frequencies are used (3 MHz, 1 MHz).
- A variety of different ping types and processing techniques: bottom tracking, bottom detection, incoherent, pulse coherent, and broadband. Many of these ping types are used in combination with each other. The exact pings types being used at any given time will depend on the operating conditions.
- The system tracks velocity and depth on a second-by-second basis and updates the ping types and processing methods as needed based on changing conditions.

For the S5, two primary data types are output.

- When the water is sufficiently shallow and slow, the system reports data from 3 MHz pulse coherent pings using a 2 cm cell size.
 - o Maximum operating depth is about 1.5 m.
 - o At a depth of 1.5 m, the maximum velocity is about 0.4 m/s. The maximum velocity increases significantly in shallower water.
- In water depths and velocities greater than above, the system uses 3 MHz incoherent pings with the cell size optimized based on the current water depth.
 - o Depths less than 2 meters use 0.1 m cells
 - o Depths 2-4 meters use 0.2 m cells.
 - o Depths greater than 4 meters use 0.4 m cells.

For the M9, several different data types are output.

- When the water is sufficiently shallow and slow, the system reports data from 3 MHz pulse coherent pings using a 2 cm cell size.
 - o Maximum operating depth is about 1.5 m.
 - o At a depth of 1.5 m, the maximum velocity is about 0.4 m/s. The maximum velocity increases significantly in shallower water.
- In moderate depth/velocity conditions, the system reports data from 1 MHz pulse coherent pings using a 6 cm cells size.
 - o Maximum operating depth is about 5.0 m.
 - o At a depth of 5.0 m, the maximum velocity is about 0.4 m/s. The maximum velocity increases significantly in shallower water.
- In water depths less than 5.0 m with velocities greater than the above, the system uses 3 MHz incoherent pings with the cell size optimized based on the current water depth.
 - o Depths less than 2 meters use 0.1 m cells

- Depths 2-4 meters use 0.2 m cells.
- Depths greater than 4 meters use 0.4 m cells.
- In water depths greater than 5.0 m, the system uses 1 MHz incoherent pings with the cell size optimized based upon the current water depth.
 - Depths less than 10 meters use 0.5 m cells
 - Depths 10-20 meters use 1.0 m cells.
 - Depths greater than 20 meters use 2.0 m cells.

The RiverSurveyor SmartPulse^{HD} uses a powerful CPU with multi-thread parallel processing routines; some key advantages from this are listed below.

- The RiverSurveyor runs multiple ping types from multiple frequencies at the same time. At any given site, the RiverSurveyor may use a total of 8-10 different ping types; at any given moment, it is typically running 3-5 ping types simultaneously.
- The parallel processing capabilities allows the system to collect new acoustic pings while at the same time analyzing data from the last set of pings. This continuous evaluation of data allows the system to modify operation, on a second by second basis, to ensure it always uses the best ping types for the conditions at that moment.
- In the case of the M9, the RiverSurveyor has the added advantage of using multiple acoustic frequencies for velocity profiling. It combines different frequencies and different Doppler processing techniques to optimize performance for the current operating conditions. The added power and flexibility provided by the additional acoustic frequency is significant and makes a major difference in final instrument performance.
- The speed of the CPU means that the RiverSurveyor has no limits in the type of processing or analysis that is done. The final performance of the RiverSurveyor is limited only by the physics of underwater sound.

SmartPulse^{HD} processing should be able to automatically adapt to any operating condition without any user input. Despite this (as a safety precaution), the updated RiverSurveyor Live PC and Mobile software includes an option to disable SmartPulse^{HD} processing.

- This option should be needed only rarely for very particular conditions where the SmartPulse^{HD} algorithms may fail.
- We have not yet encountered conditions where SmartPulse^{HD} does not work properly, but it is conceivable.
- If you use the RiverSurveyor Live option to disable SmartPulse^{HD} processing, the system will run incoherent pings only exactly as done with previous firmware releases.

Appendix G. Stationary Measurement Software

G-1. Overview

The SonTek *RiverSurveyor Stationary Live* software uses an alternative approach to the standard moving boat method of measuring water currents and discharge. Both methods use an Acoustic Doppler Profiler (ADP) to measure water currents. When using the *RiverSurveyor Stationary Live* software, however, the ADP operates from a fixed mounted position, stationary vessel, or platform (such as a SonTek Hydroboard or Tri-hull boat).

This measurement procedure is similar to that used for the SonTek FlowTracker and is in adherence to ISO velocity area measurement techniques. Measurements are made at stationary positions, usually along a tagline, to obtain a more precise representation of the mean velocity profile and therefore determine discharge.

Stationary-Measurement can be used in a wide range of applications such as:

- Discharge Measurements
- Current Profiling across transects
- Under Ice Measurements (available in future release)

G-2. System Requirements

RiverSurveyor Stationary Live requires the following minimum specifications for the PC:

- Windows 7 – 10
- 1.6 GHz processor
- 1 GB memory
- 1 GB disk space
- 1024 x 768 Screen Resolution

G-3. Installation

To install the *RiverSurveyor Stationary Live* software on your PC, insert the distribution CD into your CD-ROM drive. The program should automatically start and display the Installation Menu (Figure 117). If the installation menu does not appear in a few seconds, click Start|Run on your PC and type D:\install.exe, where D:\ is the letter of your CD-ROM drive.

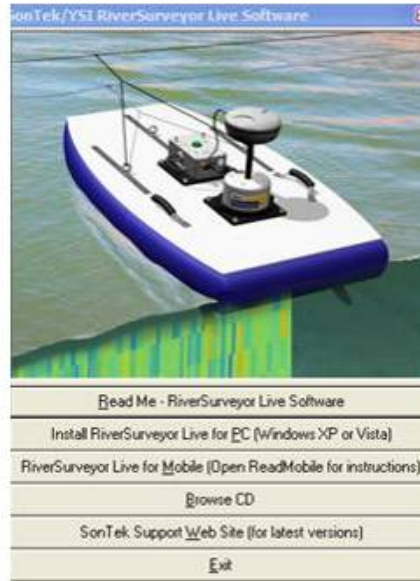

Figure 117. Installation Menu

Click the *Install RiverSurveyor Stationary Live* option. The installation wizard (Figure 118) will display step-by-step instructions to install the software.

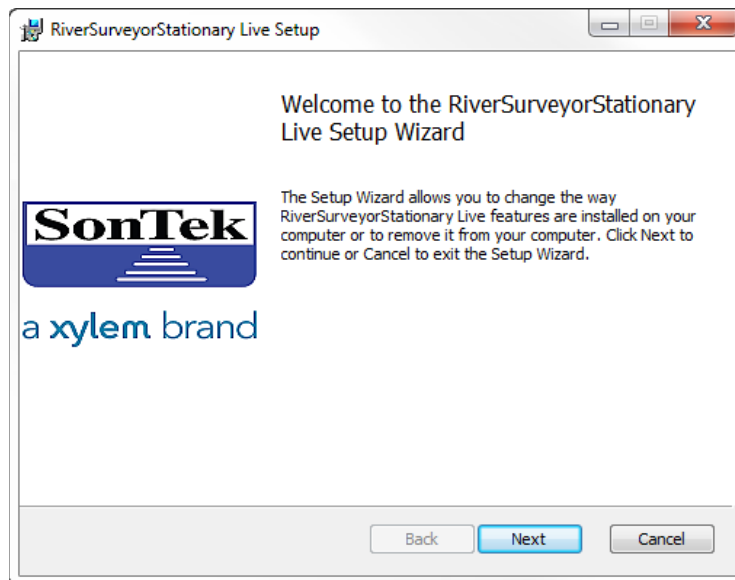

Figure 118. Desktop Installation

Beginning with RiverSurveyor Stationary Live v3.90, there is an option to enable a USGS Screening Distance feature during the software installation. The feature automatically applies a screening distance of 0.52 ft more than the transducer depth. Details of this feature can be found on the USGS Hydroacoustics website. It is disabled by default as indicated by a red X shown below:

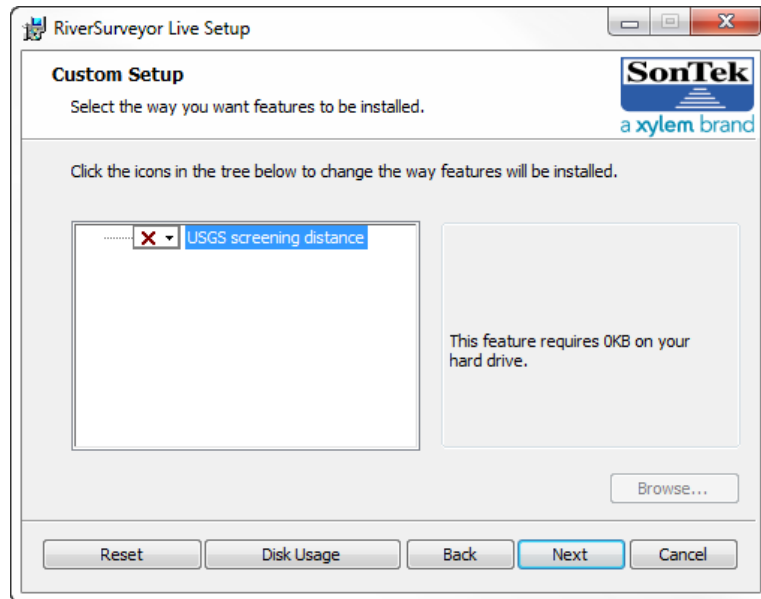

Figure 119. USGS Screening Distance Disabled

To enable the feature, click on the drop-down arrow and select Install Feature as shown below:

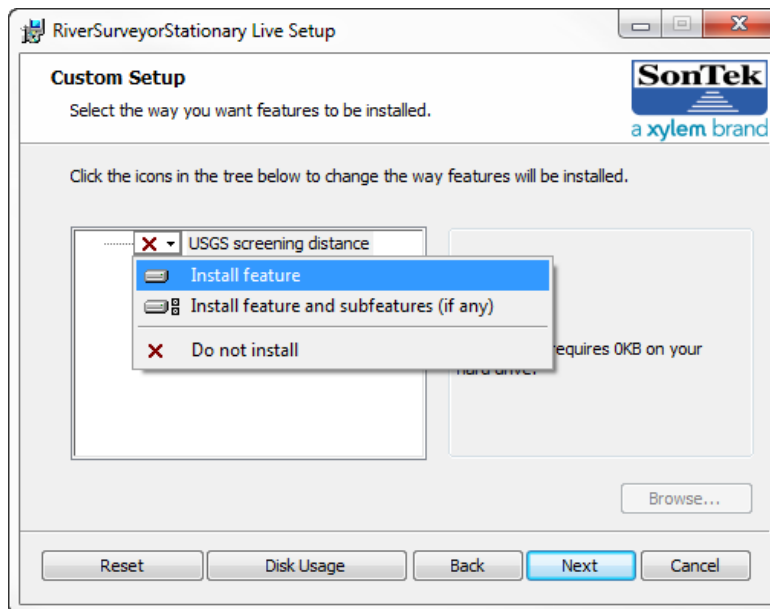

Figure 120. Enable USGS Screening Distance

Follow the on-screen instructions to complete installation of the software. You are now ready to use *RiverSurveyor Stationary Live* to make a measurement.

G-4. Making a Measurement

The primary purpose of the Stationary Measurement system is to measure the total discharge of a river cross-section. Because velocity measurements are made from a stationary position, the system does not require bottom-tracking or DGPS referenced velocity measurements. This

becomes advantageous when one or both reference techniques are unavailable due to site conditions.

Stationary discharge measurements also provide additional opportunities for measurement applications such as:

- Accurate discharge measurements under ice
- Velocity profile measurements in conditions where there are significant temporal changes in flow conditions (e.g. pulsing rivers, moving beds and channels with conditions of variable moving beds). This also includes areas of significant turbulence (such as behind bridge pilings) where instantaneous or moving vessel measurements will have significant inaccuracies.

G-4.1 Mid-Section Measurement Procedure

The procedure for making a discharge measurement follows the well-established methodology as outlined by the U.S. Geological Survey (USGS) for Discharge Measurement by Conventional Current Meters (ISO standards 768 (1997) and 9196 (1992)). This method is also referred to as the “Mid-Section method” of computing discharge and is the same method adopted by the SonTek FlowTracker.

The mid-section method involves making a series of velocity and depth measurements at a specific number of locations (more commonly known as stations, panels or verticals) across a river cross-section. At each station, the depth and mean velocity profile are measured. The depth is computed using either the 4-velocity beams, the low-frequency vertical beam, or manually measured (using a rod or other device) and entered into the software. The mean velocity profile for each station is computed from data from all valid cells above the riverbed. The width of a single station is determined to be the sum of half the distance to the previous station and half the distance to the following station. This method assumes that the velocity profile at each station represents the mean velocity for the entire rectangular station area.

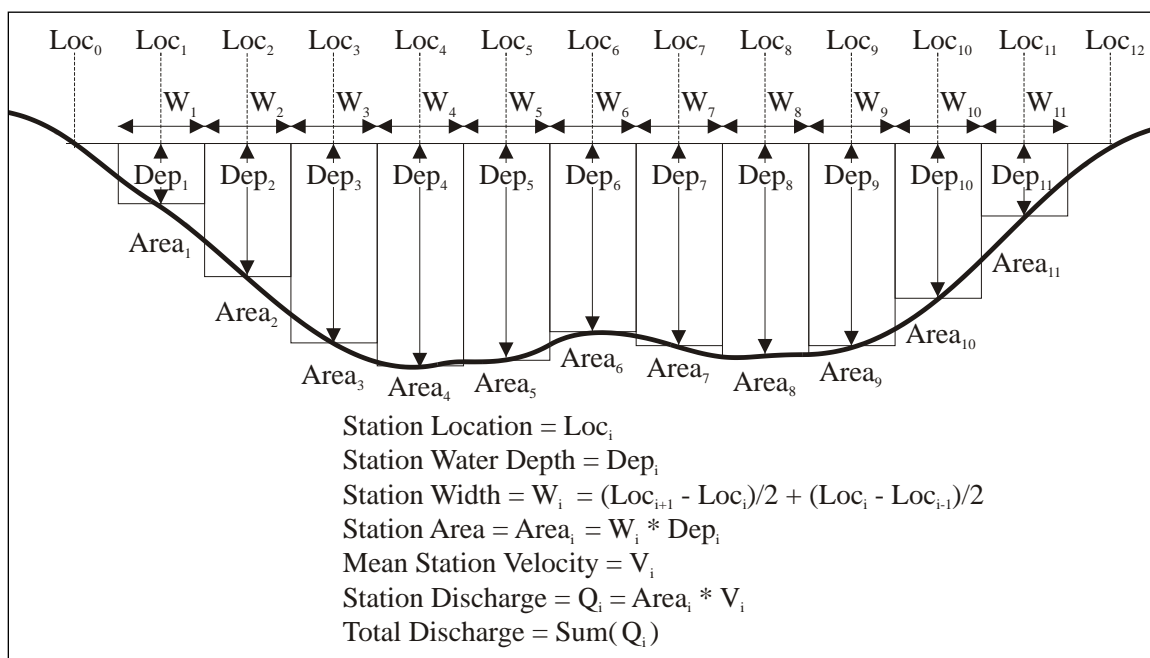

Figure 121. Basic River Discharge Measurement Method

Each station is measured for a significant time to remove any environmental and temporal variation in the water velocities. Typically, within the USGS, the recommended duration of measurement for a single station is 40 seconds. However, in particularly turbulent waters, extremely low-velocities, or in areas or rapidly changing water-level, a longer period may be required. This recommended sample time might vary from country to country and even within different organizations.

Starting with RiverSurveyor Stationary Live v4.0, a measurement can be made with the option of using GPS (either DGPS or RTK, whichever is available) for positioning purposes. The basic procedure for making a discharge measurement using the Stationary- Measurement system is the same regardless of the use of GPS. The general steps for the measurement process are as follows:

1. Setting up the Location

- A measurement section is selected based on the criteria outlined in Section G-5 below.
- A graduated tag line is strung across the river. In an ideal measurement site, the flow should be perpendicular to the tag line at all points with no flow reversals or obstructions. For ice measurements, a series of holes (one for each station) are drilled in the ice.
- The spacing of the stations along the tagline is selected so as to provide about 20-30 stations. Each of these stations should also be positioned so that no station is expected to yield more than 10 % of the total discharge. Ideally, no station should have more than 5% of the total discharge. This generally means that the stations are not equally spaced but are instead spaced closely together in deeper and high velocity areas and further apart in shallower and slower flowing areas.
- The magnetic-north heading (azimuth) of the tagline is measured. This is the compass orientation of the tagline in the direction of the right riverbank. Setting the tagline azimuth is important because it allows the M9/S5 to rotate freely around the sample location and still measure the correct mean-station velocity by using its internal compass to resolve the true direction of velocity and then calculate the normal velocity to the tagline. In the example to the right, the tag line is oriented to the southwest (225°). The azimuth should be measured with the internal compass in the ADP (preferred) or a hand-held compass.

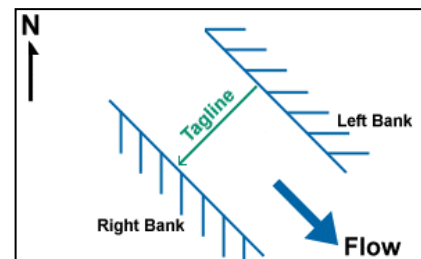

2. Setting up the Software

- Connect to the ADP through the software.
- Enter the site and system information into the software. This information includes the site name, number, location, starting bank, gauge heights, azimuth, velocity-reference method, depth reference method, rated discharge and any additional weather or measurement conditions comments.

3. Make the Measurement

- The operator starts at one edge (the start bank), recording the starting-edge location, water depth and gauge heights.
- The operator then proceeds to the first station and enters the station location, transducer depth, and gauge heights (not required). If ice is present, the values for the ice thickness, depth of water and slush thickness should also be entered.

- The M9/S5 is positioned with the transducers submerged and the system as vertical as possible. Ideally the system will be mounted to a platform, vessel, or mounting structure.
- Data collection begins and the M9/S5 measures the 3D current velocities and bottom depth throughout the water column.
- Only the component of water velocity perpendicular to the transect line (or azimuth) is used to ensure proper discharge calculations, regardless of the flow direction. This normal component of the velocity is known as the “Normal Velocity”. The true flow direction or “True Velocity” is still measured, recorded and will be displayed on screen or as a comparison with the Normal Velocity.
- At the end of the averaging time for the measurement, the discharge is calculated using the formula shown in Figure 121.
- Repeat the steps above at each station along the transect until the last station is completed. Press the End Section button when the last station is completed.
- The ending-edge location and depth are recorded.

4. Post Measurement

- The quality of the entire measurement is assessed and recorded.
- The total discharge (the sum of all station discharges), the total area and mean velocity are displayed with graphs of parameters for the entire transect.
- A report of the entire measurement can then be generated for review.
 - The report includes the estimated uncertainty of the final discharge calculation; the uncertainty calculation is described in G-9.1.

In the following sections you will first find detailed instructions on how to set up the Stationary measurement and your M9. Then, the operating procedure will go into detail about how to take measurements without GPS, and with GPS, respectively.

G-5. Selecting a Measurement Location

The key issues to consider when selecting the location of your measurement cross-section are:

- Select an area of relatively uniform and steady flow. Try to avoid areas with standing eddies or strong turbulence. Note that a measurement may still be made in these areas however it may take longer to establish a mean profile (i.e. the averaging interval may need to be increased).
- The cross-section should have gradual changes in depth.
- Flow along the riverbanks should be low or close to zero.

G-6. M9/S5 Mounting and Instrument Orientation

Mounting: The mount to which the M9/S5 will be attached should meet the following criteria as closely as possible. Please remember that while the transducer depth should be as shallow as possible, the transducers must be completely submerged at **all** times during data collection. The key to good Stationary-Measurement data collection is that the transducers remain in a position that is relatively constant in location to the riverbank.

- Rigid and level when the transducer is in the water to minimize vibration.
- For some applications it is advantageous that the mount be easily retractable when the vessel is moving from one station to the next.
- As with a moving vessel measurement; on small to mid-sized boats (10' – 25') - the mount can extend over the bow; on larger boats, it is preferable to mount the ADP on either the port or starboard side near mid-ship.

- Transducer depth should be adjustable.
- Constructed of non-ferrous material (ideally aluminum).
- Make sure the M9/S5 is at least a few meters away from the engine or any other ferromagnetic objects mounted to the boat to ensure proper operation of the compass (if used in ENU orientation).
- The vessel maintains as much as possible a constant and steady position and orientation to the riverbank. Note: Bottom-tracking velocity reference is preferred if there is significant motion of the vessel during data collection.

Instrument Orientation: This is important when making measurements with using the XYZ orientation (i.e. similar to the FlowTracker reference) and/or when using the internal compass (ENU) to determine the tagline azimuth. In the first case, the x-velocity measured by the system is used to compute discharge for that particular station. This will require that the systems x-axis is pointed facing downstream as shown in Figure 122 below. In this orientation, the connector located on the M9/S5 housing will be facing directly downstream. In addition, the M9/S5 should not be allowed to rotate during data collection (similar to using a FlowTracker).

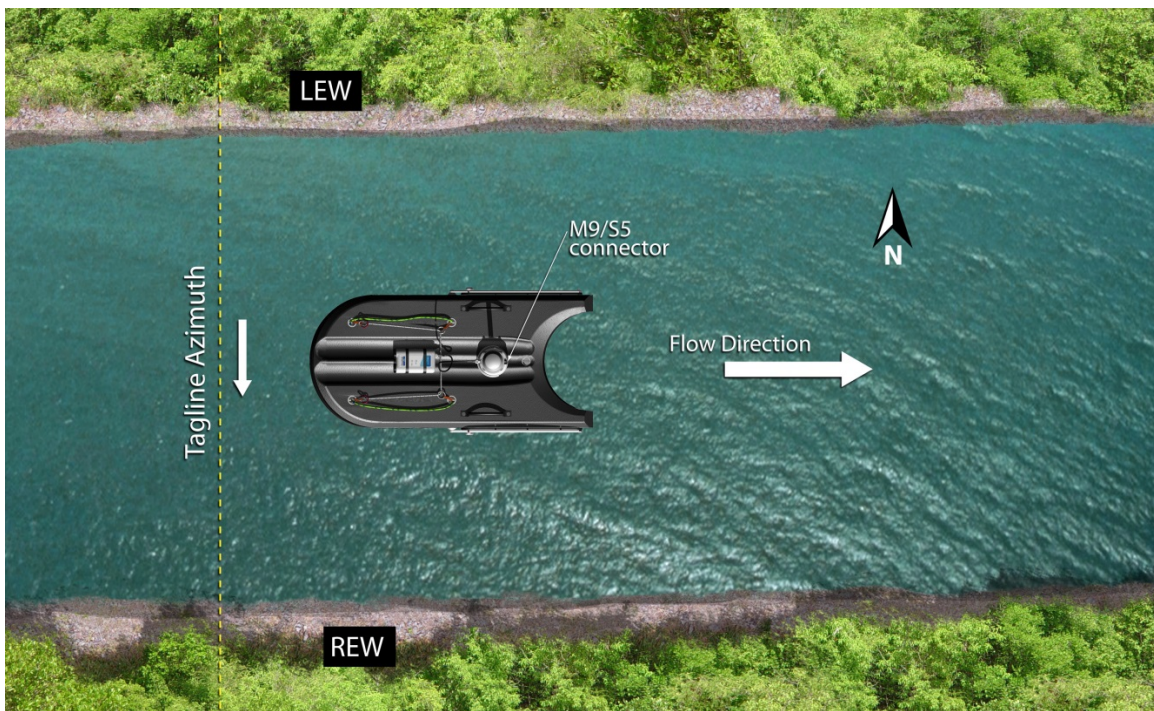

Figure 122. Instrument Orientation

In most cases, the ENU orientation will be preferred during data collection. The primary reason is that when using the ENU orientation the system will always measure the true velocity and the normal velocity regardless of its angle to the tagline. This ability is helpful in many river conditions especially when you are deploying the system from a small boat with a line. In this case, the boat can freely rotate into the current as it changes in the cross-section and using the internal compass it will accurately compute the true velocity and normal velocity. The same system orientation shown in the figure above must be used when measuring the tagline azimuth using the internal compass of the M9/S5. This procedure (Get Tagline Azimuth) is described in Section G-7.4.

In Section G-7, you will find operating instructions for taking a measurement without using the GPS. Instructions for taking a measurement with GPS will follow, in Section G-8.

G-7. Software Operation – Without GPS

G-7.1 Connecting to the System

Ensure that all other software programs that access the serial ports are closed before starting the software.

NOTE: SonTek recommends disabling your computer's Bluetooth and WiFi options when connecting with the RiverSurveyor as these may conflict with the SonTek USB Radio.

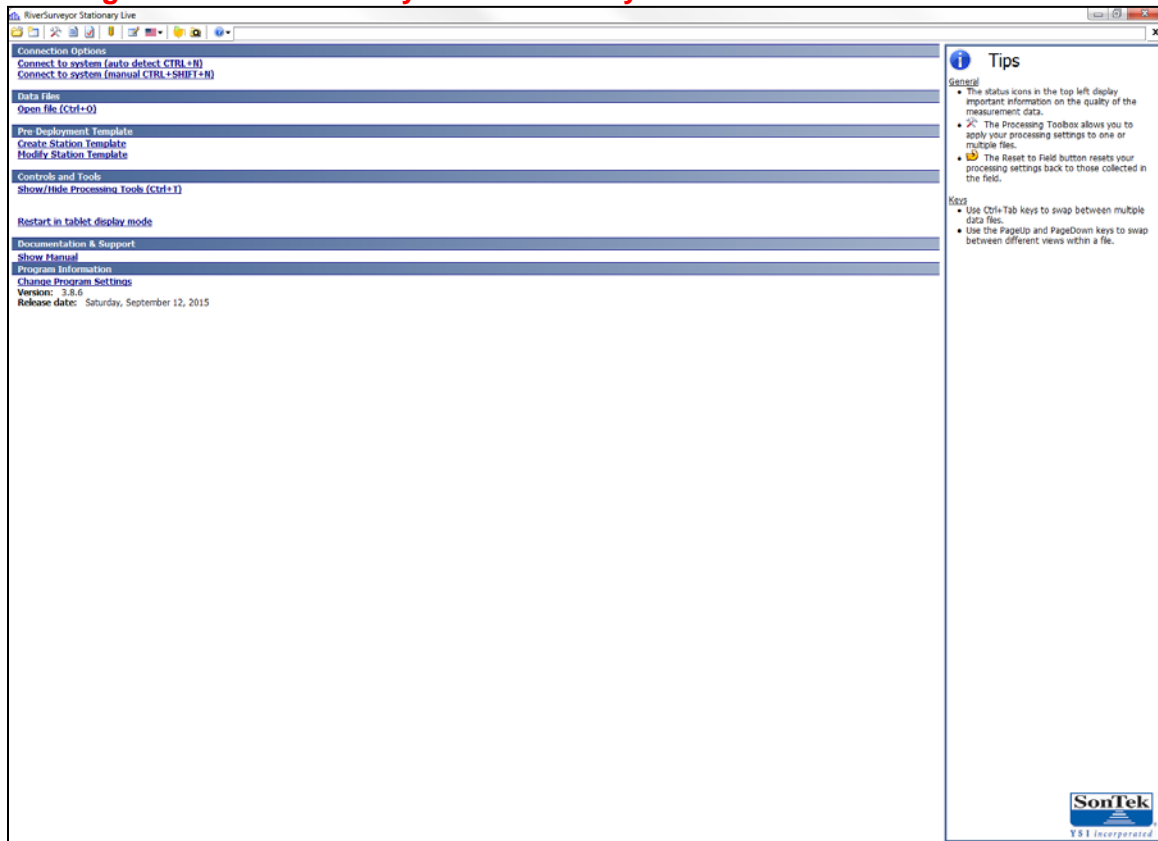

Figure 123. Main Menu

Start the software from the **Start** button and then **Programs | SonTek Software | Stationary-Measurement**. The start screen will be displayed as shown above in Figure 123.

There are three ways to connect to the M9/S5:

- Click the Connect icon on the toolbar at the top of the screen



- Use one of the *Connect to system* links under Connection Options
- Use the hot keys: CTRL+N (auto detect) or CTRL+SHIFT+N (manual)

Clicking on the Connect icon or the Auto Detect CTRL+N link will open a window to select a system serial number available for connection. Highlight the serial number and click Connect as shown below.

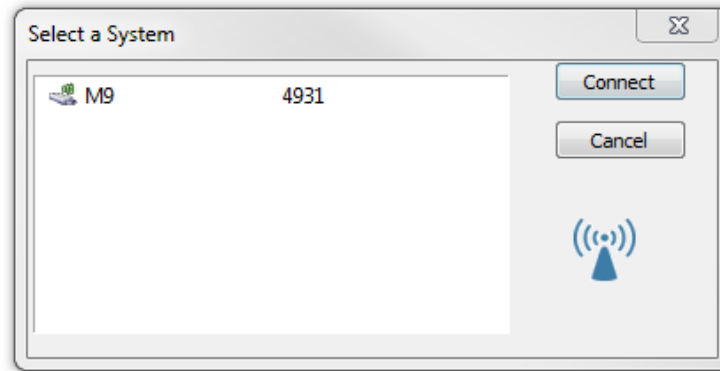

Figure 124. Select a System

Alternatively, clicking on the Connect to System (Manual CTRL+SHIFT+N) will open a window to select a COM port by number. Check the Parani Radio button if using the Bluetooth serial radio with a first generation PCM. Check the SonTek Radio button if using the 2.4 GHz USB radio with a second generation PCM.

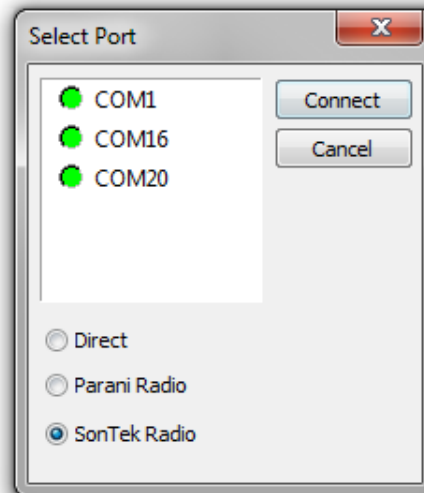

Figure 125. Select COM Port

A Warning message will appear if the M9/S5 doesn't have the latest firmware installed. The firmware can be downloaded from www.sontek.com.

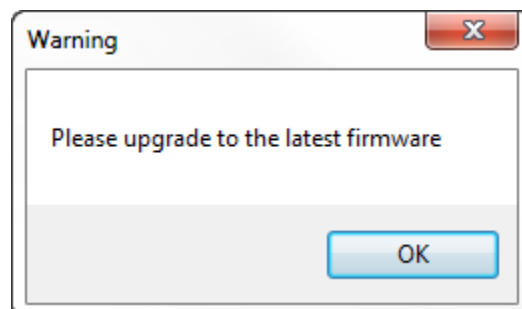

Figure 126. Firmware Upgrade Warning

The Start Page screen, shown below in Figure 127, will be displayed once communication with the system has been established.

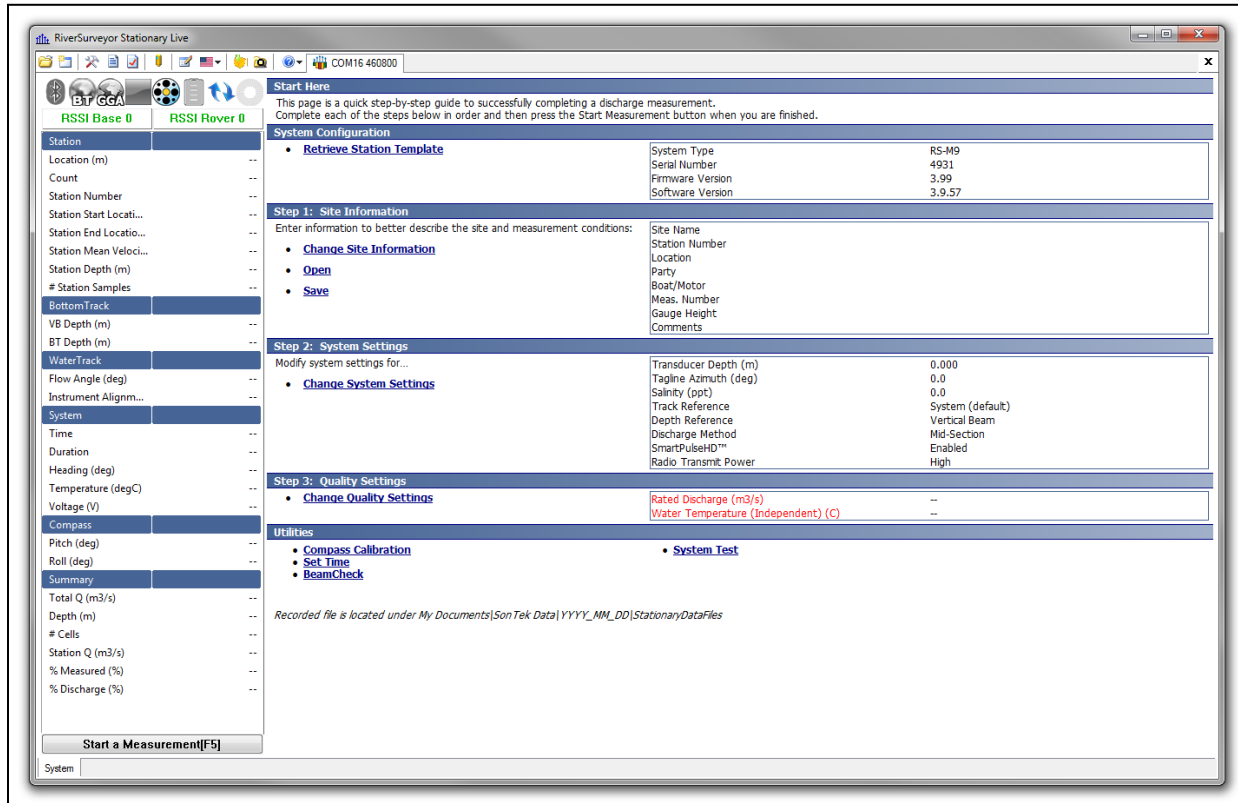

Figure 127. Start Page

This screen is used to input site information, program system settings, rated discharge (to compute percent measured for each station) and perform utility functions. Once you have input this information you can press the **Start a Measurement (F5)** button to begin your measurement.

G-7.2 System Configuration

System configuration displays the system type (M9 or S5), the system serial number, and the firmware version for reference purposes.

If you have an existing Station Template, clicking **Retrieve Station Template** will open a dialog to open a station template file (*.statemp). A station template file can be created by opening an existing RiverSurveyor Stationary Live file (*.sta). Under the System tab, in the System Configuration section, you will see **Save Station Template** where Retrieve Station Template would be during a measurement. Clicking Save Station Template will create a station template file. The Station Template is a record of all settings associated with each station for that measurement, and these settings will be pre-populated during the new measurement if that station template is used.

G-7.3 Step 1: Site Information

The Site Information dialog covers information related to the site itself, including the name and personnel involved in the measurement.

It is recommended that all fields on this page be filled in prior to starting the measurement. This data will be displayed in the Discharge Measurement Report and will improve both the record keeping and data review processes.

The Site Information dialog (Figure 128) will be displayed. Press the **Tab** key to step through each of the displayed parameters.

Field Name	Value
Site Name(50 Chars)	Westside High Line
Station Number(20 Chars)	8348-T21
Location(50 Chars)	100' DS of Dam
Party(25 Chars)	TPimble, Flabbe
Boat/Motor(30 Chars)	HydroBoard
Meas. Number(20 Chars)	2
Gauge Height(25 Chars)	7.234
Comments(250 Chars)	Windy, warm

Figure 128. Site Information

The site information can be saved for future measurements by clicking **Save**. This will create a *.stasiteinfo file. To load a previously saved site information template, click **Open**.

G-7.4 Step 2: System Settings

Click **Change System Settings** to input Transducer Depth, Tagline Azimuth, Salinity, Track Reference, Depth Reference, Discharge Method, SmartPulse enabling, and Radio Transmit Power. This will display the System Settings dialog (Figure 129).

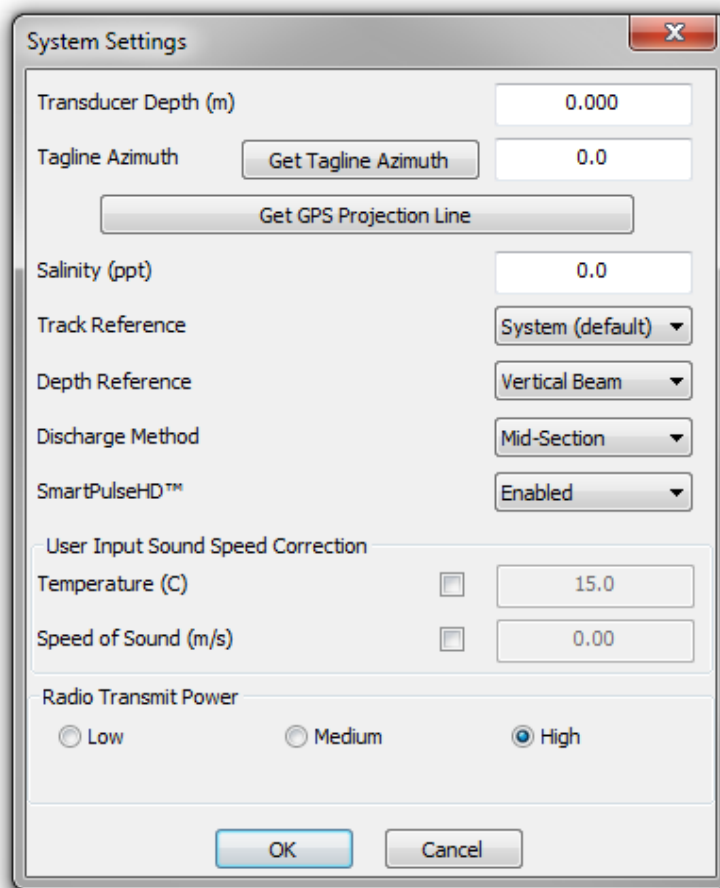

Figure 129. System Settings

Transducer Depth: The transducer depth is defined as the distance from the vertical beam of the S5/M9 to the water surface. It must be measured when the M9 is mounted to the platform that will be used during a measurement. If you are using a Hydroboard, the white line on the side of the Hydroboard can be used to calculate the transducer depth. The distance for both the S5 and M9 with the fairing to the white line is 4.5 inches (114.3mm). If the ADP head is mounted flush with the fairing, simply subtract the distance of the white line to the water line from 4.5 inches (114.3mm) to get the transducer depth.

Tagline Azimuth: It is important to set the tagline azimuth if you are using the ENU orientation. The tagline azimuth (Figure 130) is the heading (direction) in degrees from magnetic north of the tagline going towards the right bank. The normal velocity is used to compute discharge for each station. The following illustration shows the proper orientation of the M9/S5 (connector should always be oriented pointing downstream), the tagline azimuth relative to magnetic north and the REW, and the downstream flow direction.

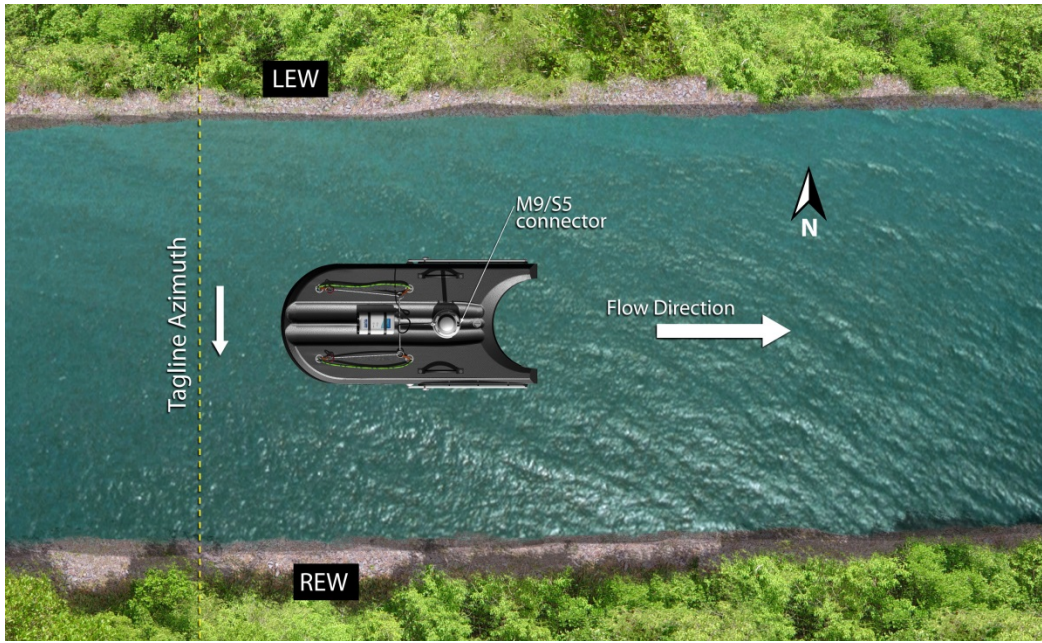

Figure 130. Tagline Azimuth

If you have previously determined the tagline azimuth for this site, then simply input that value and proceed to the next tab. If you do not know the azimuth you can use the system's internal compass to determine the tagline azimuth by pressing **Get Tagline Azimuth** which will display the Get Tagline Azimuth dialog, shown below in Figure 131.

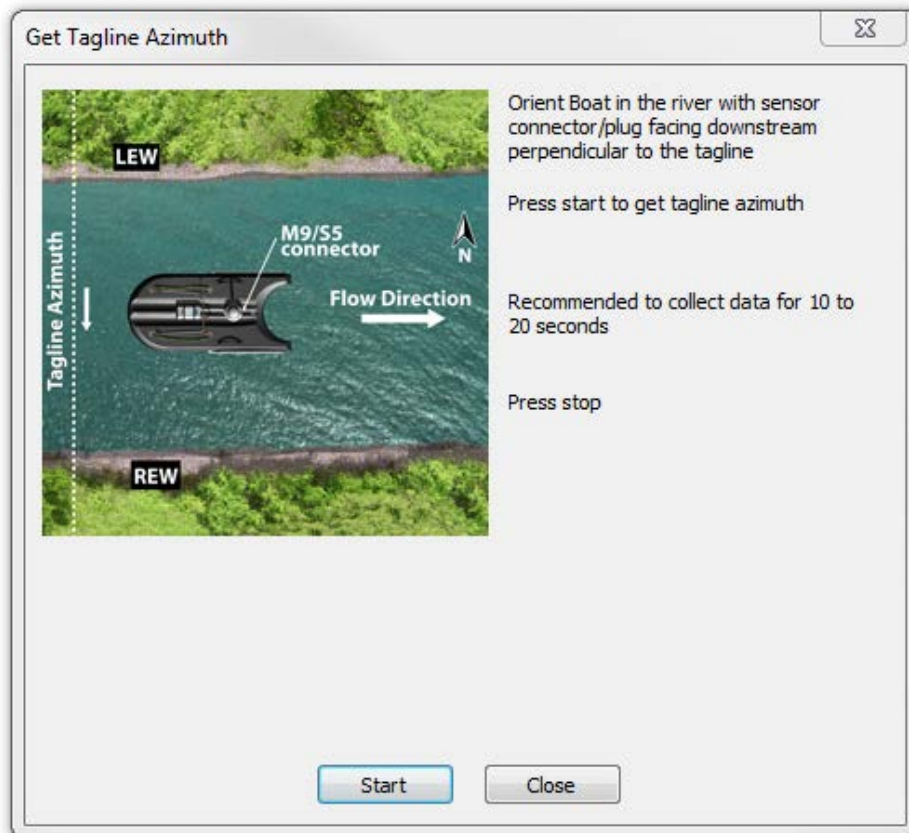

Figure 131. Get Tagline Azimuth

Follow the simple procedure outlined in the *Get Tagline Azimuth* dialog as follows:

1. Align the M9/S5 power and communications connector to point directly downstream. If you are deploying the instrument from a floating platform (i.e. boat, tri-hull, hydroboard, etc...) then simply lower the boat into the water and allow it to align itself with the flow. This is typically best done in a location near the center of the river in a section of flow that flowing directly downstream.
2. Once the M9/S5 has been correctly aligned with the river and is relatively steady press **Start** to collect data. During this time the compass will display instrument heading at 1-second intervals, average instrument heading, computed tagline azimuth, and the number of samples (in seconds) as shown in Figure 132. After 20-30 seconds of data collection press **Stop** and close the dialog. The tagline azimuth field in the system settings dialog box will automatically be updated with the tagline azimuth measured using *Get Tagline Azimuth*.

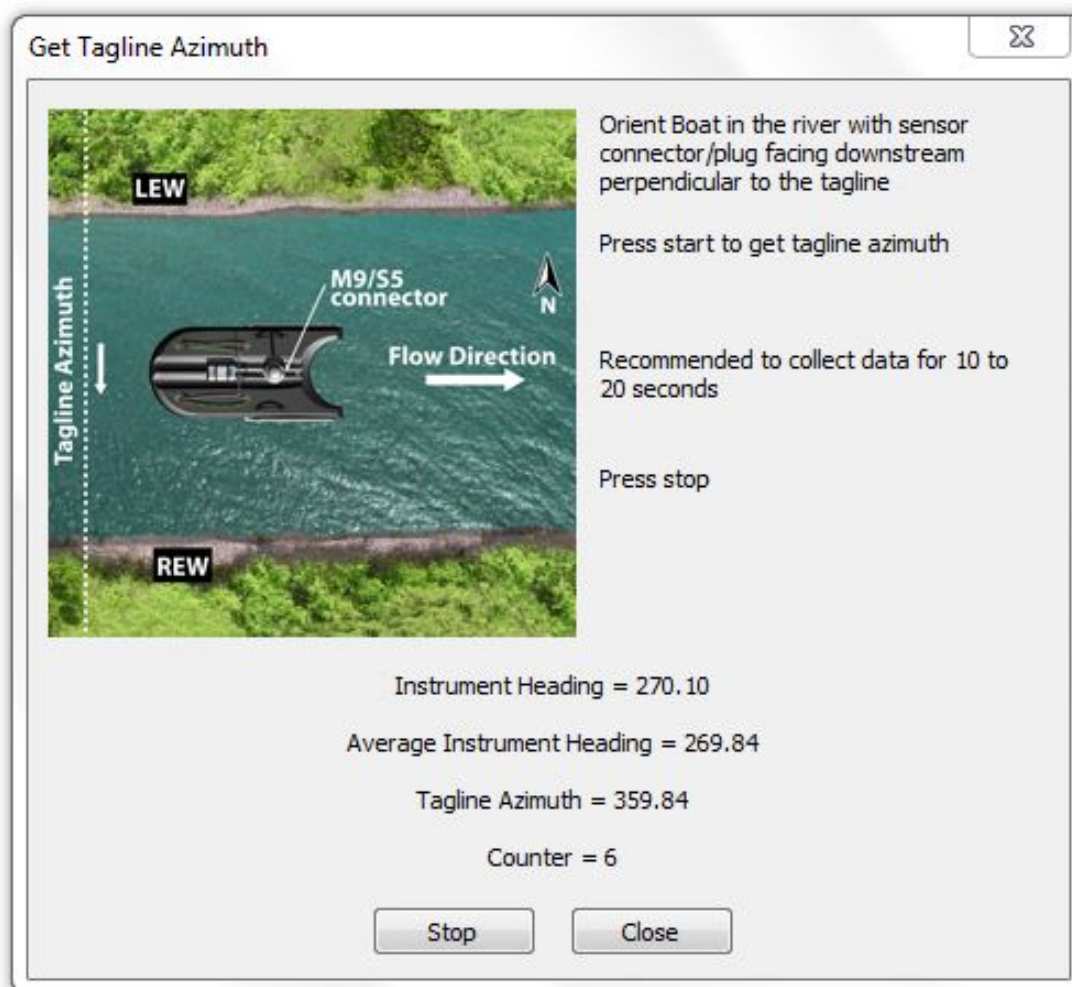

Figure 132. Get Tagline Azimuth

Get GPS Projection Line: This setting is required if you are taking a measurement with GPS. Instructions for taking a measurement with GPS are outlined in Section G-8. It is not required for measurements without GPS and can be ignored.

Salinity: Input the water salinity (psu) at the transducer face (example: freshwater = 0, sea water = 34.5 ppt).

The screenshot shows a 'System Settings' dialog box with the following fields and controls:

- Transducer Depth (ft): 0.328
- Tagline Azimuth: Get Tagline Azimuth button, 20.3
- Get GPS Projection Line button
- Salinity (ppt): 0.0
- Track Reference: System (default) dropdown
- Depth Reference: Vertical Beam dropdown
- Discharge Method: Mid-Section dropdown
- SmartPulseHD™: Enabled dropdown
- User Input Sound Speed Correction section:
 - Temperature (F): 59.0
 - Speed of Sound (ft/s): 0.00
- OK and Cancel buttons at the bottom.

Figure 133. Salinity

Track Reference: Select either **System (default)** or **Bottom-Track** as a track reference. In most cases, because the M9/S5 is stationary during a measurement the *System* track reference will be preferred. Selecting *Bottom-Track* as a track reference is also acceptable for discharge calculations; however, it will typically be used as a check against the stationary reference in post-processing for quality assurance purposes. Both *System* and *Bottom-Track* reference data are recorded and can be changed in post-processing if desired.

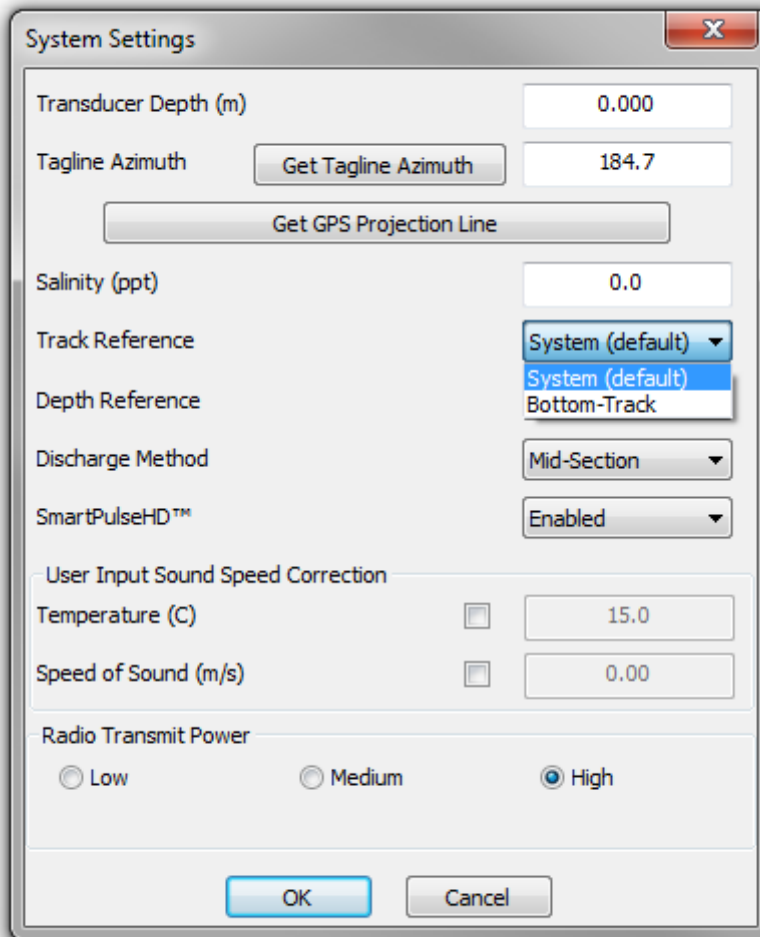

Figure 134. Track Reference

Depth Reference: Select either **Vertical Beam** or **Bottom-Track** as a depth reference. The M9/S5 measures depth using a center vertical beam and also a 4-beam averaged depth. In most cases, the vertical beam will be preferred to provide a depth reading directly below the instrument. If the vertical beam depth measurement is not available, then the M9/S5 will automatically use the 4-beam *Bottom-Track* depth.

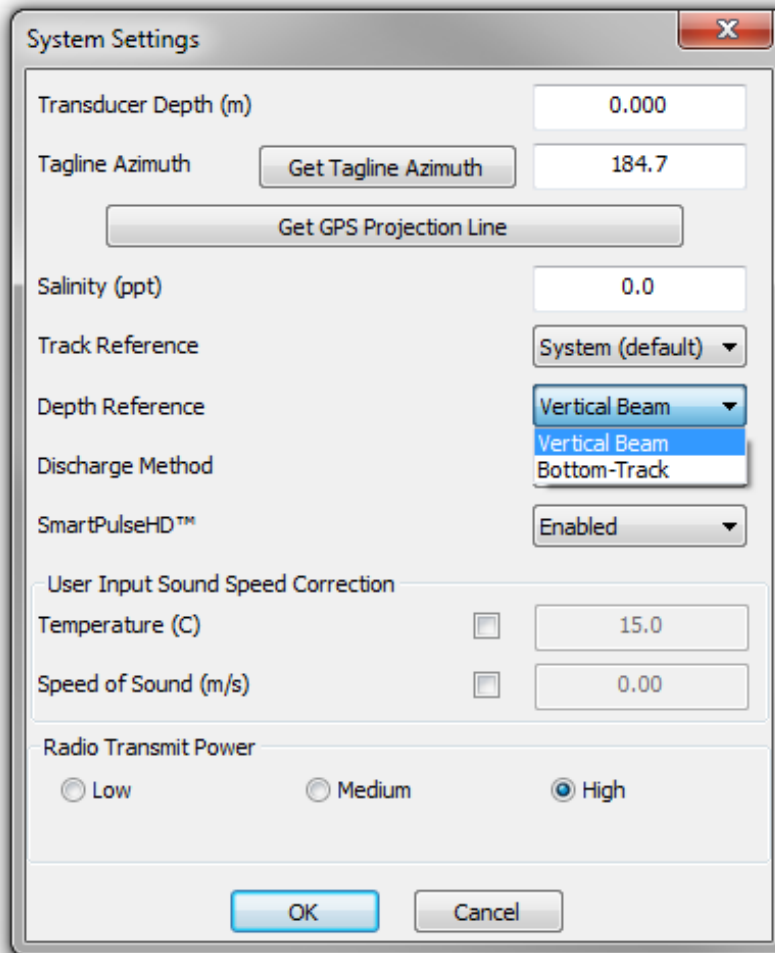

Figure 135. Depth Reference

Discharge Method: Select either the Mid-Section or Mean-Section method for calculating discharge.

SmartPulseHD: Select whether to enable or disable SmartPulseHD. In most cases, you will want SmartPulseHD to be *enabled*. Disabling SmartPulseHD will force the M9/S5 into incoherent pinging mode and the system will not automatically select the best ping type for the measurement. Disabling SmartPulseHD should be used with caution and may affect your measurement quality.

User Input Sound Speed Correction: In the case where you would like to input a manual sound speed correct from an external temperature or sound speed probe, you can enable the fields by checking the box, and inputting the values from your external source. These values will be used to calculate velocity.

Radio Transmit Power: Select the radio transmit power. If you notice communications issues due to large distances between the Rover and your computer or difficulty getting a direct line of sight between the two, increasing the radio transmit power can improve the quality of communications.

Once the System settings are configured, press **OK** to continue.

G-7.5 Step 3: Quality Settings

Rated Discharge: The rated discharge used to calculate the percent discharge measured for each station. To input the rated discharge, click the update button and input the correct value. The percent measured discharge is used as a data quality parameter to assist in determining the correct width of a section.

Water Temperature (Independent): This is a separate water temperature from an independent source that can be recorded for quality monitoring purposes. This value is not used in any velocity calculations and is for the user reference only.

Measurement quality: This parameter is only available in post-processing (after opening a data file) and can be used to reference the quality of the measurement. The user can choose to qualify the measurement as Excellent, Good, Fair, or Poor.

G-7.6 Utilities

The Utilities section includes links to the Compass Calibration, Set Time, Beam Check, System Test, and Update Firmware. Please refer to Section 6.11 of the manual for a complete description of each.

G-7.7 Data Collection

To begin data collection, press the **Start a Measurement (F5)** button located towards the upper left-hand side of the screen. In order to prevent data loss in the event of a power, communications or computer issue during a measurement, the data file stored on the computer can be reopened to complete the measurement.

Start Edge (Station 1)

The *Start Edge* dialog box will open as shown in Figure 136.

Figure 136. Start Edge

Press the **Cancel** button to return to the system settings page and review the current system and data collection settings.

The Start Edge (Station 1) dialog will show several parameters, but only the relevant fields will be enabled in this step. Input the correct start bank (Left or Right), the starting location (edge of water on river bank measured from the tagline), the water depth at the start location (0 is typically used for a slope bank), velocity correction factor (1 is typical for most start and end locations), gauge height and auxiliary gauge height (i.e. water-level) if known, and the observation time of the gauge height reading.

First Measured Station (Station 2)

Once the fields are updated press the **OK (Enter)** button and move the instrument to the first measurement location (Station 2). The station dialog will automatically open.

The following is a brief description of each field in the station dialog:

Location from initial point: Distance measured from start bank (or reference point) using tagline.

Distance between stations: Distance between this station and the last station.

User Input Water Depth: Only required if M9/S5 depth measurement is not available.

Water Surface Type: Open Water, Ice Cover or Ice + Slush.

Ice Thickness: Enabled when Water Surface Type is Ice or Ice + Slush.

Water Surface to Bottom of Ice: Enabled when Water Surface Type is Ice or Ice + Slush.

Water Surface to Bottom of Slush Ice: Enabled when Water Surface Type is Ice + Slush.

Transducer depth below ice: Enabled when Water Surface Type is Ice or Ice + Slush.

Transducer depth below water surface: Depth of instrument below water surface. If Water Surface Type is Ice or Ice + Slush, this field is automatically recalculated to reflect ice thickness settings above.

Screening Distance: This is the distance below the water surface that you want to start collecting data rather than relying on the default setting of the instrument. In essence this setting allows you to program the ADP to start collecting data below a certain point. This is primarily used for boat mounted applications where the screening distance can be set to avoid flow disturbance from the wake of the boat. Note: An accurate Transducer Depth is required.

Screening Distance = Transducer Depth + depth to screen below instrument.

Coordinate System: ENU or XYZ. ENU enables compass and references measurements from magnetic north. XYZ disables compass and references measurements from the internal system axis. Coordinate reference can be changed on a station by station basis if required.

Averaging Time: Time (in seconds) over which data will be collected and averaged for each station. Longer averaging times in general tend to better represent a true mean discharge in the river. For example - USGS recommends minimum 40-seconds.

Velocity Correction Factor: 0 – 1. Value of 1 is most common. Please refer to your agencies' guidelines for reducing this factor.

Gauge Height: Observed water level from a known datum at your measurement location. Not required for data collection.

Auxiliary Gauge Height: Second water-level reference measurement from a similar datum. Not required for data collection.

Island Edge: Select to insert an island in the measurement section. Choosing this option once creates an island start edge. The software will require the next station to be an island end edge. More details on the Island Edge setting can be found at the end of this section.

The screenshot shows the 'Station 2' dialog box with the following fields and values:

Location from initial point (ft)	0.78
Distance between stations (ft)	0.78
Water Surface Type	Open Water
Ice Thickness (ft)	0.00
Water Surface To Bottom Of Ice (ft)	0.00
Water Surface To Bottom Of Slush Ice (ft)	0.00
Transducer depth below ice (ft)	0.000
Transducer depth below water surface (ft)	0.328
User Input Water Depth (ft)	0.00
Screening Distance (ft)	0.85
Coordinate System	ENU
Averaging Time	40
Velocity Correction Factor	1.00
Gauge Height (ft)	0.000
Auxiliary Gauge Height (ft)	0.000
GH Observation Time	12:12:52 PM

Additional features include a 'Use Gps' checkbox (checked), a graphical 'Station Window' showing a sonar beam in a water column, and buttons for 'Profile Extrapolation', 'Measure [Enter]', 'Cancel', and 'End Edge'. An 'Island Edge' checkbox is also present.

Figure 137. Station Dialog

Once the M9/S5 is in position, enter all relevant information into the appropriate field. On the far-right side of the station dialog is the graphical display of the vertical water column for the Station. This graphical display is known as the **Station Window** and is visible for all stations.

Measurement Tip: When the Station dialog first opens, the instrument will also start “Pinging” showing you the SNR (signal to noise ratio) profile plot for each beam and the number of valid cells for measurement. This information is provided to help make a better determination of the first measurement location. In addition, once the measurement is complete the system continues “Pinging” and displays this data as you move it to the next measurement location. Typically, it is recommended that you have a minimum of 2 valid cells and that the SNR profile plot shows the beams are measuring similar depths and are not obstructed by something below the water surface.

Press the **Measure** button to begin collecting data, **Cancel** to go back to review the measured station information, or **End Edge** to input the end edge location information. If you press Cancel to go back, you must press Next Station (F5) in the upper left-hand corner of the window to proceed with the measurement.

Data Collection Screen

Once the **Measure** button has been pressed, the station data will be displayed in 1-second intervals in the Data Collection Screen, as shown in **Figure 138**.

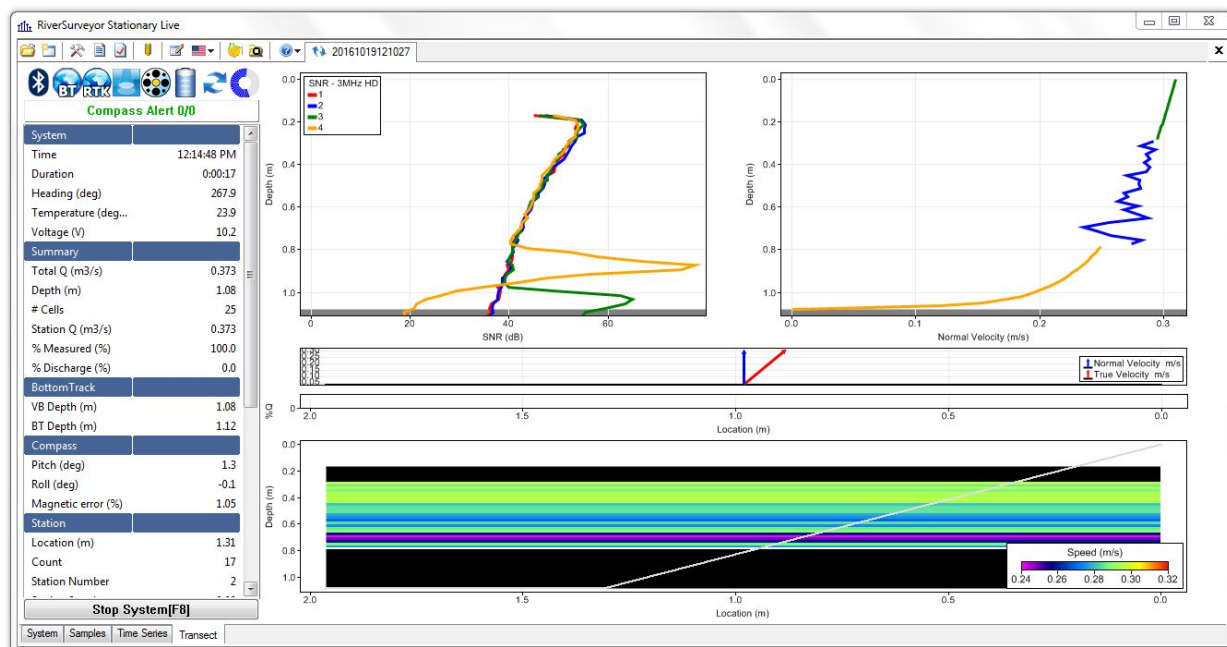

Figure 138. Station Measurement

While the station is being measured, you will see a few status icon changes in the upper left corner of the screen (Figure 139). The right-most icon shows a time counter during the measurement. To the left of that, blue arrows will rotate when the station is being actively measured. Other icons are the same as can be found in the RiverSurveyor Live software and are described in Appendix A.

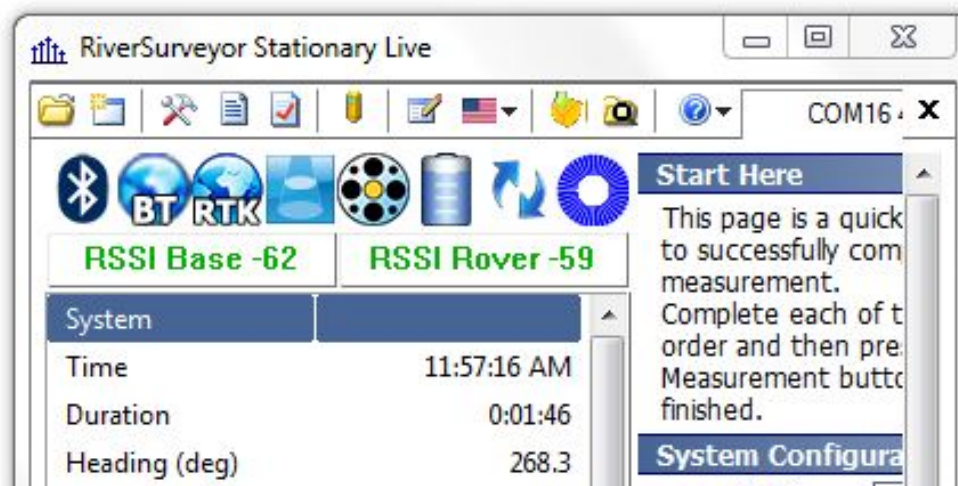

Figure 139. Status Icons During Data Collection

A summary table is located below the icons to provide real-time and summary information for the station. The two profile plots at the top of the screen show the SNR (averaged signal-to-noise ratio) and normal velocity (averaged) by default and can be changed by right-clicking on

the plots. During a typical measurement, these values are the most useful to monitor the performance and conditions. Below these is the vector velocity plot. Arrows representing the normal velocity measured for the station are shown. Right-click to toggle to the true (measured) velocity on the same plot. Below this is the Percent Discharge plot. If a Rated Discharge was entered in the System tab, the percent discharge at each station will be calculated based on the Rated Discharge. The display will show colors indicating the percent discharge at each station (Green = <5%, Yellow = 5-10%, Red = >10%). The bottom plot shows the transect along the tagline with current Speed displayed in color. Although most people find the Speed display the most useful during a measurement, this can also be changed by right-clicking on the bottom plot itself.

Once the station measurement is complete, a Measurement Results dialog (shown in Figure 140) will automatically display a summary of the measurement. Review this information and then press **Accept** to proceed to the next station or **Repeat** to measure the same station again.

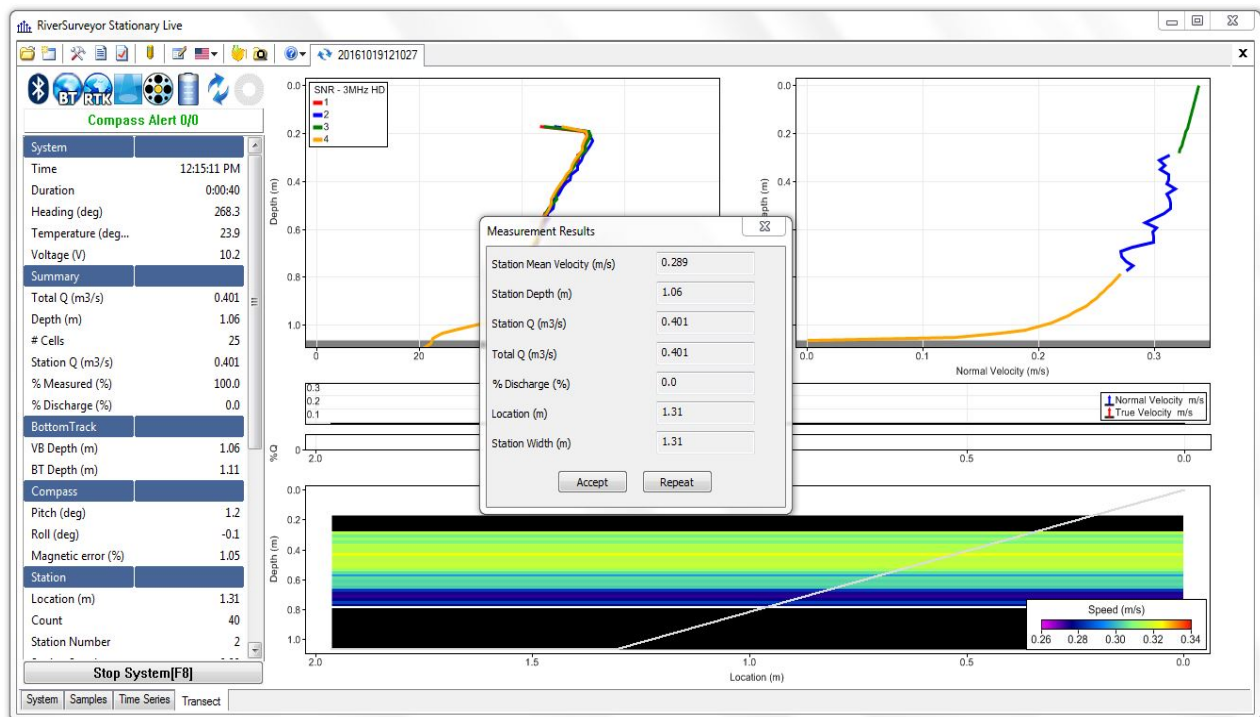

Figure 140. Station Measurement Results

Adding More Stations and Reviewing Stations

Once Accept is clicked, a Station Dialog box will automatically appear, prompting input for the next station. Duplicate the above process, measuring stations as needed for the entire transect.

To review previous stations already measured for reference, simply click **Previous** or **Next** in the **Station Dialog** (shown in Figure 141). When reviewing each station, the Measure button will be disabled. In order to re-measure at a station, please see the section called **Re-measuring a Station** below.

Station 3

Previous Next

Location from initial point (m) 2.00

Distance between stations (m) 1.00 Use Gps

Water Surface Type Open Water

Ice Thickness (m) 0.00

Water Surface To Bottom Of Ice (m) 0.00

Water Surface To Bottom Of Slush Ice (m) 0.00

Transducer depth below ice (m) 0.000

Transducer depth below water surface (m) 0.000

User Input Water Depth (m) 0.00

Screening Distance (m) 0.00

Coordinate System ENU

Averaging Time 40

Velocity Correction Factor 1.00

Gauge Height (m) 0.000

Auxiliary Gauge Height (m) 0.000

GH Observation Time 2:50:05 PM

Water

Bottom

Island Edge

Profile Extrapolation Measure [Enter] Cancel End Edge

Figure 141. Review Stations using Previous and Next Buttons

If you want to review all station data before moving to the next station, press Cancel. You will be able to view data and information from the bottom left tabs as follows:

- **System Tab:** view the system settings that were input at the beginning of the measurement
- **Samples Tab:** You will be able to view information from each station in a tabular format. An example of the samples tab is shown in **Figure 142**. Through this tab, you will be able to edit stations by clicking the **edit stations** button for each station. This will bring up the Station Dialog, where you can edit the setup parameters for each station at any time.
- **Time Series Tab:** The time series of various parameters can be displayed using this tab. To change what is displayed right-click on each plot.
- **Transect Tab:** This tab shows the same plots that you see during each station measurement. Clicking on a station location in the bottom transect plot automatically changes the top profile plots to reflect data from that location (Figure 143).

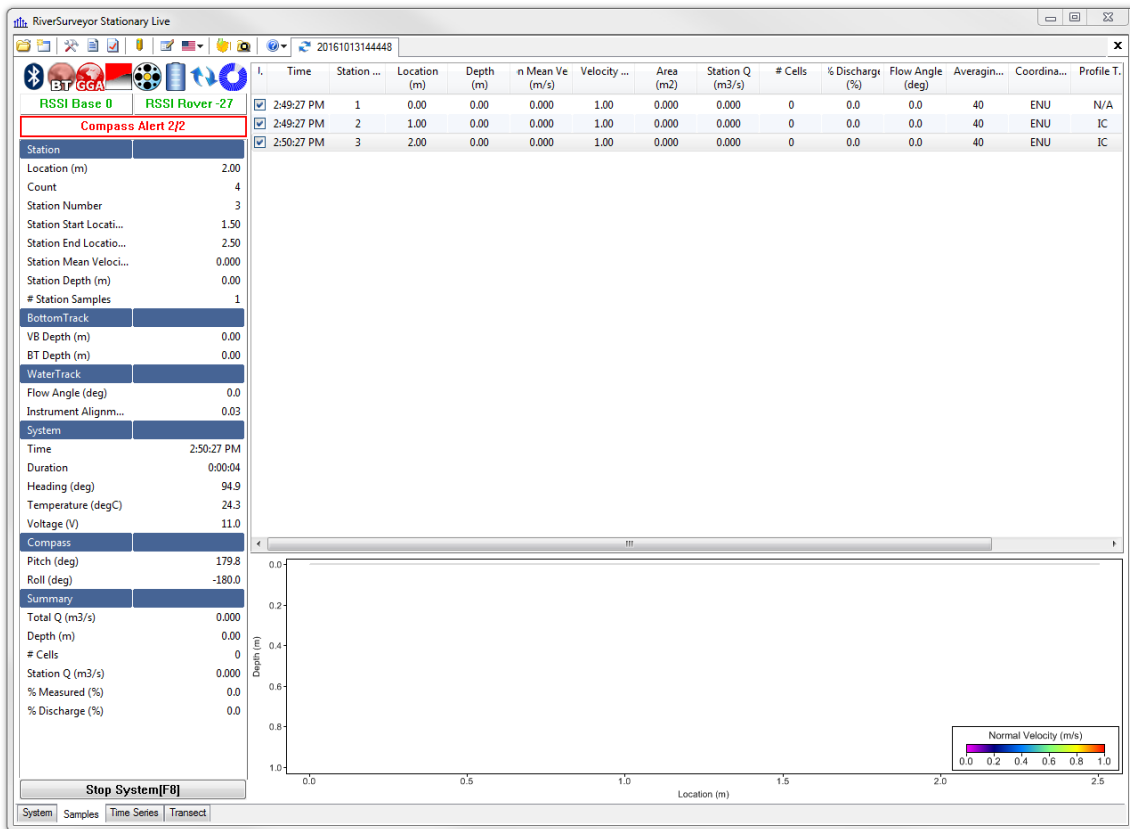

Figure 142. Samples Tab

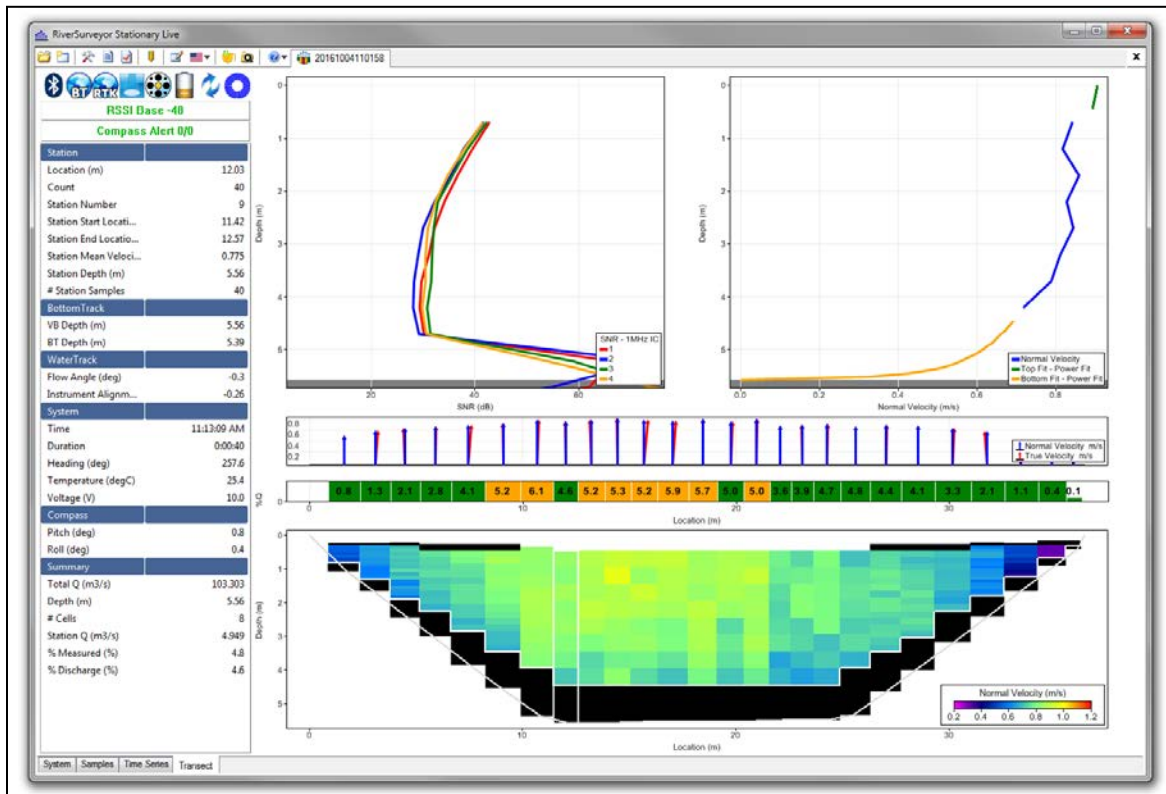

Figure 143. Data Collection Screen

Inserting a Station

The operator can insert a station at any time during the measurement. In the station dialog, the operator will input a station location to be inserted and click **Measure**. The inserted station will be sorted and included in the total discharge calculation.

Re-measuring a Station

To re-measure a station, simply start a new station and enter the location of the station that you wish to replace. You will see a warning to replace the station, shown in **Figure 144**. Click **Yes** to re-measure at that station.

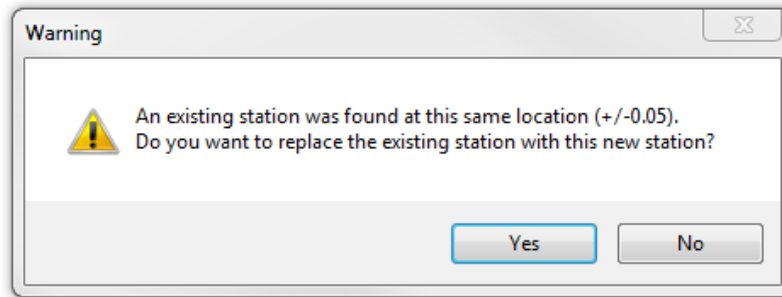

Figure 144. Re-Measuring a Station

Island Edges

If a river is split into multiple channels, any internal island(s) must be accounted for in the discharge calculation. The stations at each edge of the internal island(s) are treated like the river edges.

The operator can click the **Island Edge** box at the bottom of the station dialog window. The window header will change from *Station* to *Island Start Edge* as shown in **Figure 145**. Enter the location, depth and other information where appropriate. Click **OK (Enter)** and the software will prompt the operator to enter *Island End Edge* information automatically before continuing to the next measurement station (**Figure 146**).

Island Start Edge
⌵

Location from initial point (m)	<input type="text" value="3.00"/>	
Distance between stations (m)	<input type="text" value="1.00"/>	<input type="checkbox"/> Use Gps
Water Surface Type	<input type="text" value="Open Water"/>	
Ice Thickness (m)	<input type="text" value="0.00"/>	
Water Surface To Bottom Of Ice (m)	<input type="text" value="0.00"/>	
Water Surface To Bottom Of Slush Ice (m)	<input type="text" value="0.00"/>	
Transducer depth below ice (m)	<input type="text" value="0.000"/>	
Transducer depth below water surface (m)	<input type="text" value="0.000"/>	
User Input Water Depth (m)	<input type="text" value="0.00"/>	
Screening Distance (m)	<input type="text" value="0.00"/>	
Coordinate System	<input type="text" value="ENU"/>	
Averaging Time	<input type="text" value="40"/>	
Velocity Correction Factor	<input type="text" value="1.00"/>	
Gauge Height (m)	<input type="text" value="0.000"/>	
Auxiliary Gauge Height (m)	<input type="text" value="0.000"/>	
GH Observation Time	<input type="text" value="2:55:15 PM"/>	

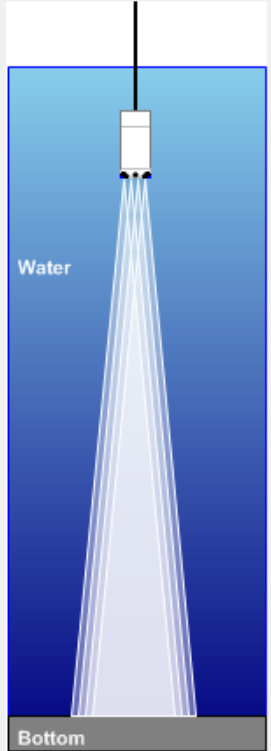

Island Edge

Figure 145. Island Start Edge

The 'Island End Edge' dialog box contains the following fields and controls:

- Location from initial point (m): 4.00
- Distance between stations (m): 1.00
- Water Surface Type: Open Water
- Ice Thickness (m): 0.00
- Water Surface To Bottom Of Ice (m): 0.00
- Water Surface To Bottom Of Slush Ice (m): 0.00
- Transducer depth below ice (m): 0.000
- Transducer depth below water surface (m): 0.000
- User Input Water Depth (m): 0.00
- Screening Distance (m): 0.00
- Coordinate System: ENU
- Averaging Time: 40
- Velocity Correction Factor: 1.00
- Gauge Height (m): 0.000
- Auxiliary Gauge Height (m): 0.000
- GH Observation Time: 2:56:06 PM
- Buttons: Profile Extrapolation, OK [Enter], Cancel
- Diagram: A vertical cross-section showing a transducer at the surface emitting a conical beam into the water. The water is labeled 'Water' and the bottom is labeled 'Bottom'. A checkbox 'Island Edge' is checked.

Figure 146. Island End Edge

End Edge and End Transect

When you have completed data collection of the last station, press **End Edge** to input the ending edge location. Press **OK** to end the measurement. Once the measurement has ended you will not be allowed to insert any additional stations. Once all the Stations and the End Edge have been entered, press the **End Transect** button to complete the measurement. The discharge summary report will be automatically generated and displayed. The software will close this file for editing at this time. To enable editing of the file, you must re-open the file.

G-8. Software Operation – WITH GPS

Starting in RiverSurveyor Stationary Live v4.0, the GPS can be used to determine the position of each station. To take a measurement with GPS, first make sure all GPS cables and antennae are set up correctly, and that the lights on your PCM indicate that you are getting a proper GPS fix. The GPS can be used with both DGPS (DIF) or RTK. If switching between RTK and DGPS is desired, you must do so first in RiverSurveyor Live before using RiverSurveyor Stationary Live.

As previously mentioned, the ability to use GPS provides a more accurate way to set station locations, especially when the M9/S5 system is not perfectly stationary during the measurement duration. With a Stationary measurement entirely using GPS, no physical tag line (tape measurer) is required, as station distances are determined automatically. However, you will have the choice to use GPS at each station, or to enter in a manual station location.

Many of the steps required to take a Stationary measurement are the same regardless of whether or not GPS is used, but there are many additional features to consider when GPS is used. During the measurement, GPS can be enabled or disabled at each station, thus giving the user flexibility to enter in a manual location value if desired or when a GPS lock is difficult to achieve (i.e. on banks where tree cover is significant).

G-8.1 Step 1: Connecting to the System

Ensure that all other software programs that access the serial ports are closed before starting the software.

NOTE: SonTek recommends disabling your computer's Bluetooth and WiFi options when connecting with the RiverSurveyor as these may conflict with the SonTek USB Radio.

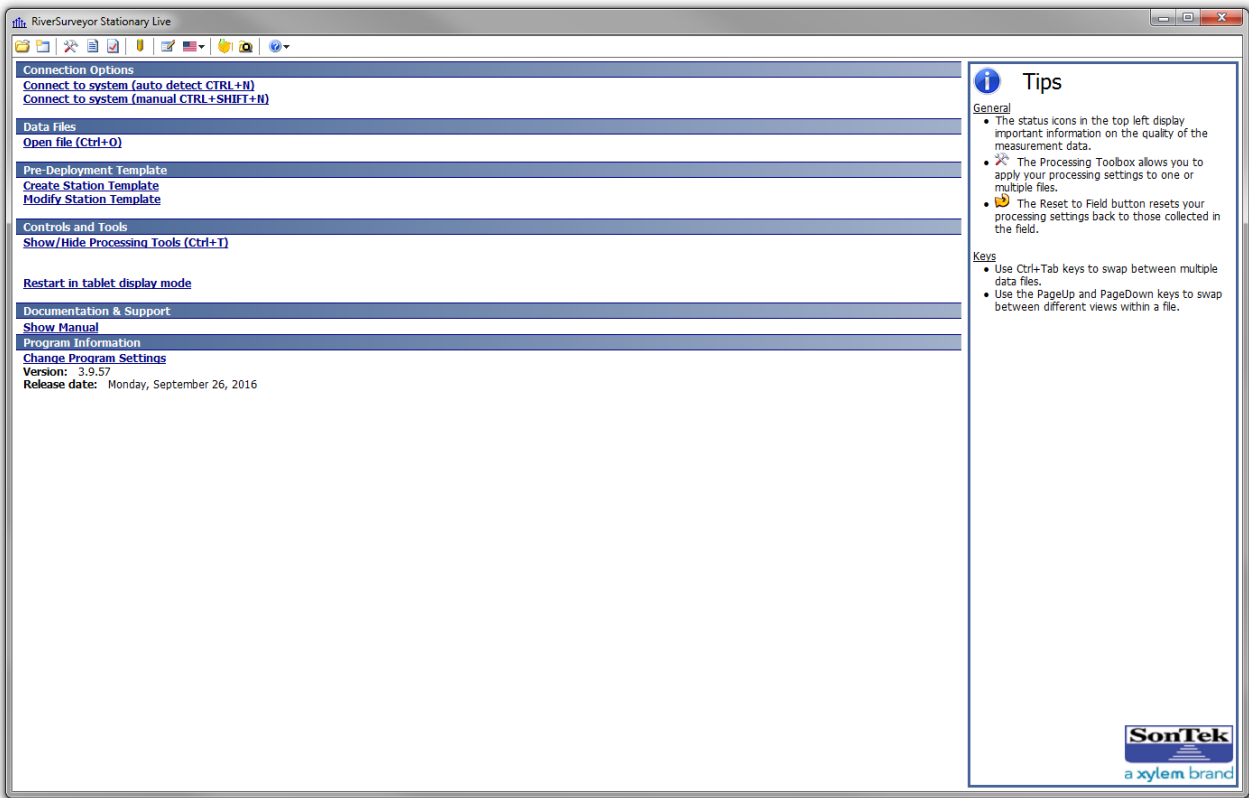

Figure 147. Main Menu

Start the software from the **Start** button and then **Programs | SonTek Software | Stationary-Measurement**. The start screen will be displayed as shown above in Figure 147.

There are three ways to connect to the M9/S5:

- Click the Connect icon on the toolbar at the top of the screen



- Use one of the *Connect to system* links under Connection Options
- Use the hot keys: CTRL+N (auto detect) or CTRL+SHIFT+N (manual)

Clicking on the Connect icon or the Auto Detect CTRL+N link will open a window to select a system serial number available for connection. Highlight the serial number and click Connect as shown below.

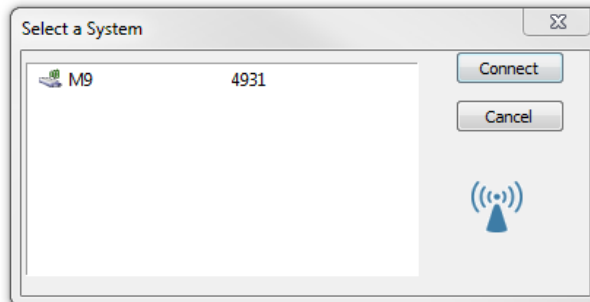

Figure 148. Select a System

Alternatively, clicking on the Connect to System (Manual CTRL+SHIFT+N) will open a window to select a COM port by number. Choose the Direct toggle if the M9 is connected directly to the computer (no PCM). Choose the Parani Radio toggle if using the Bluetooth serial radio with a first generation PCM. Choose the SonTek Radio toggle if using the 2.4 GHz USB radio with a second generation PCM.

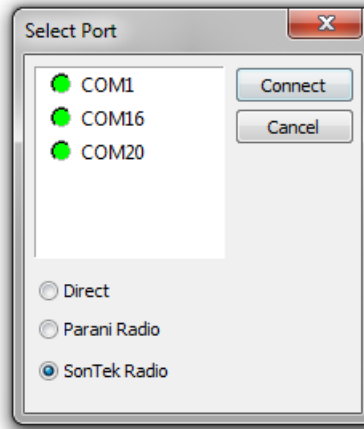

Figure 149. Select COM Port

A Warning message will appear if the M9/S5 doesn't have the latest firmware installed. The firmware can be downloaded from www.sontek.com.

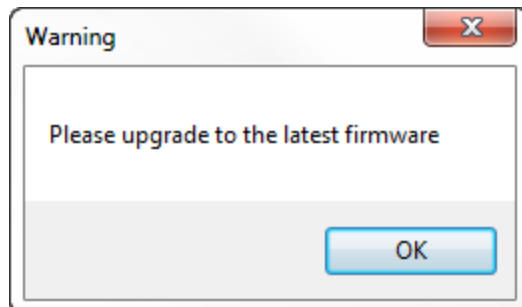

Figure 150. Firmware Upgrade Warning

The Start Page screen, shown below in Figure 151, will be displayed once communication with the system has been established.

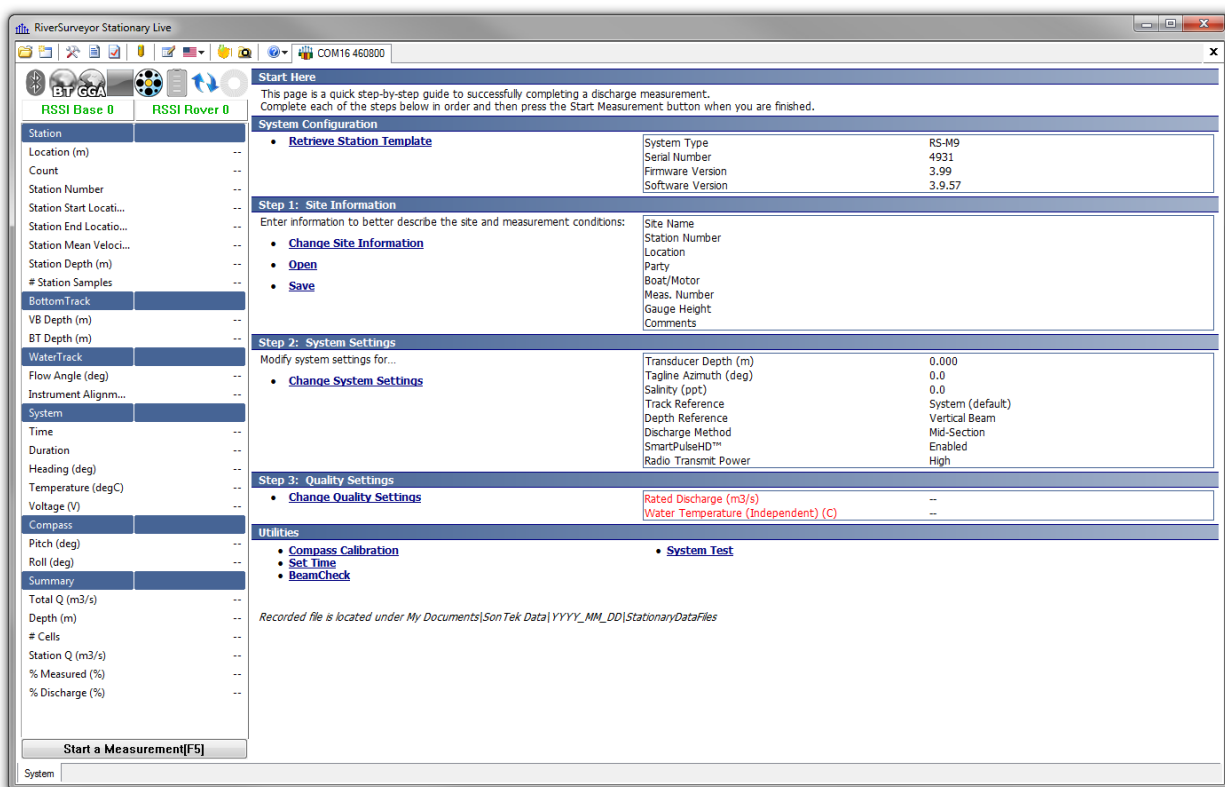

Figure 151. Start Page

This screen is used to input site information, program system settings, rated discharge (to compute percent measured for each station) and perform utility functions. Once you have input this information you can press the **Start a Measurement (F5)** button to begin your measurement.

G-8.2 System Configuration

System configuration displays the system type (M9 or S5), the system serial number, and the firmware version for reference purposes.

If you have an existing Station Template, clicking **Retrieve Station Template** will open a dialog to open a station template file (*.statemp). A station template file can be created by opening an existing RiverSurveyor Stationary Live file (*.sta). Under the System tab, in the System Configuration section, you will see **Save Station Template** where Retrieve Station Template would be during a measurement. Clicking Save Station Template will create a station template file. The Station Template is a record of all settings associated with each station for that measurement, and these settings will be pre-populated during the new measurement if that station template is used.

G-8.3 Step 1: Site Information

The Site Information section covers information related to the site itself, including the name and personnel involved in the measurement.

It is recommended that all fields on this page be filled in prior to starting the measurement. This data will be displayed in the Discharge Measurement Report and will improve both the record keeping and data review processes.

Clicking **Change Site Information** will display the Site Information dialog (Figure 152). Press the **Tab** key to step through each of the displayed parameters.

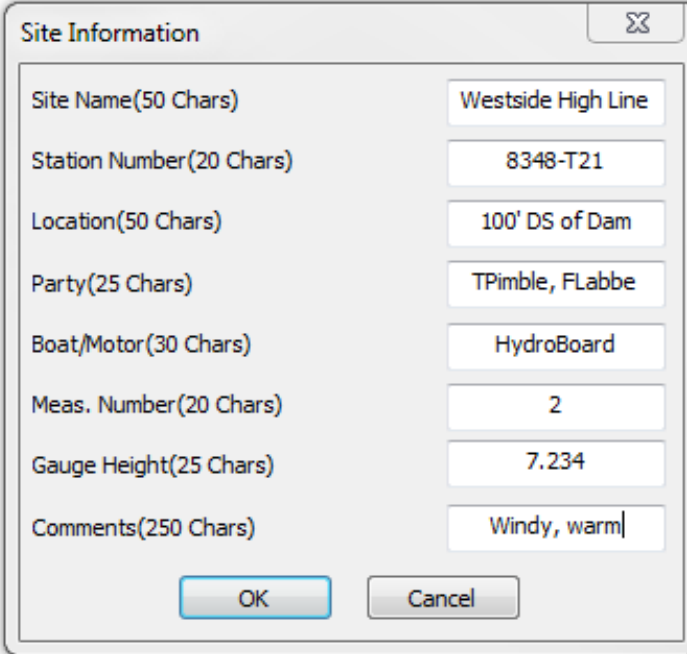

Field Name	Value
Site Name(50 Chars)	Westside High Line
Station Number(20 Chars)	8348-T21
Location(50 Chars)	100' DS of Dam
Party(25 Chars)	TPimble, FLabbe
Boat/Motor(30 Chars)	HydroBoard
Meas. Number(20 Chars)	2
Gauge Height(25 Chars)	7.234
Comments(250 Chars)	Windy, warm

Figure 152. Site Information

The site information can be saved for future measurements by clicking **Save**. This will create a *.stasiteinfo file. To load a previously saved site information template, click **Open**.

G-8.4 Step 2: System Settings

Click **Change System Settings** to input Transducer Depth, Tagline Azimuth, Salinity, Salinity, Track Reference, Depth Reference, Discharge Method, SmartPulse enabling, and Radio Transmit Power. This will display the System Settings dialog (Figure 153).

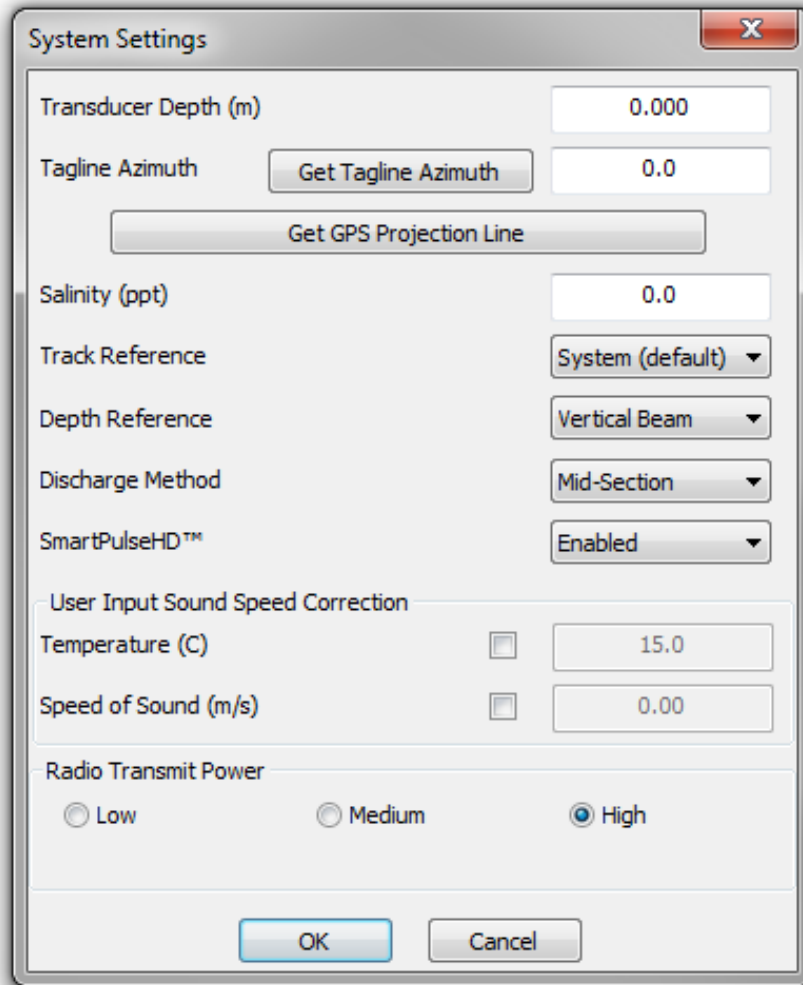

Figure 153. System Settings

Transducer Depth: The transducer depth is defined as the distance from the vertical beam of the S5/M9 to the water surface. It must be measured when the M9 is mounted to the platform that will be used during a measurement. If you are using a Hydroboard, the white line on the side of the Hydroboard can be used to calculate the transducer depth. The distance for both the S5 and M9 with the fairing to the white line is 4.5 inches (114.3mm). If the ADP head is mounted flush with the fairing, simply subtract the distance of the white line to the water line from 4.5 inches (114.3mm) to get the transducer depth.

Tagline Azimuth: It is important to set the tagline azimuth if you are using the ENU orientation. The tagline azimuth (Figure 154) is the heading (direction) in degrees from magnetic north of the tagline going towards the right bank. The normal velocity is used to compute discharge for each station. The following illustration shows the proper orientation of the M9/S5 (connector should always be oriented pointing downstream), the tagline azimuth relative to magnetic north and the REW, and the downstream flow direction.

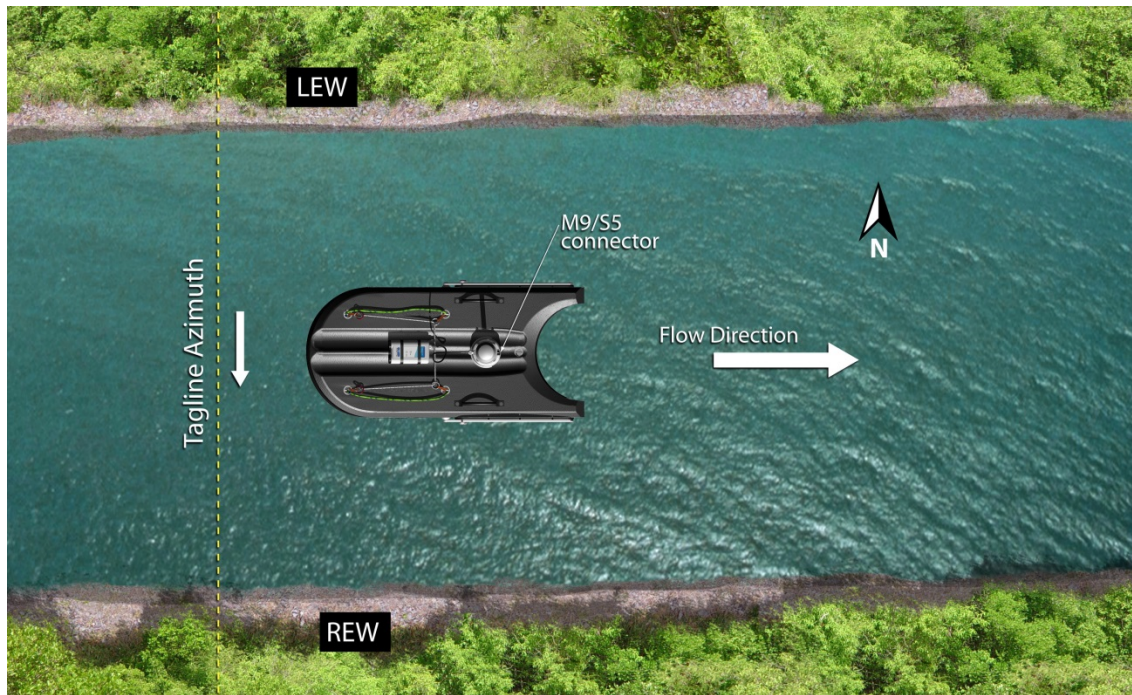

Figure 154. Tagline Azimuth

If you have previously determined the tagline azimuth for this site, then simply input that value and proceed. If you do not know the azimuth you can use the system's internal compass to determine the tagline azimuth by pressing press **Get Tagline Azimuth** which will display the Get Tagline Azimuth dialog, shown below in Figure 155.

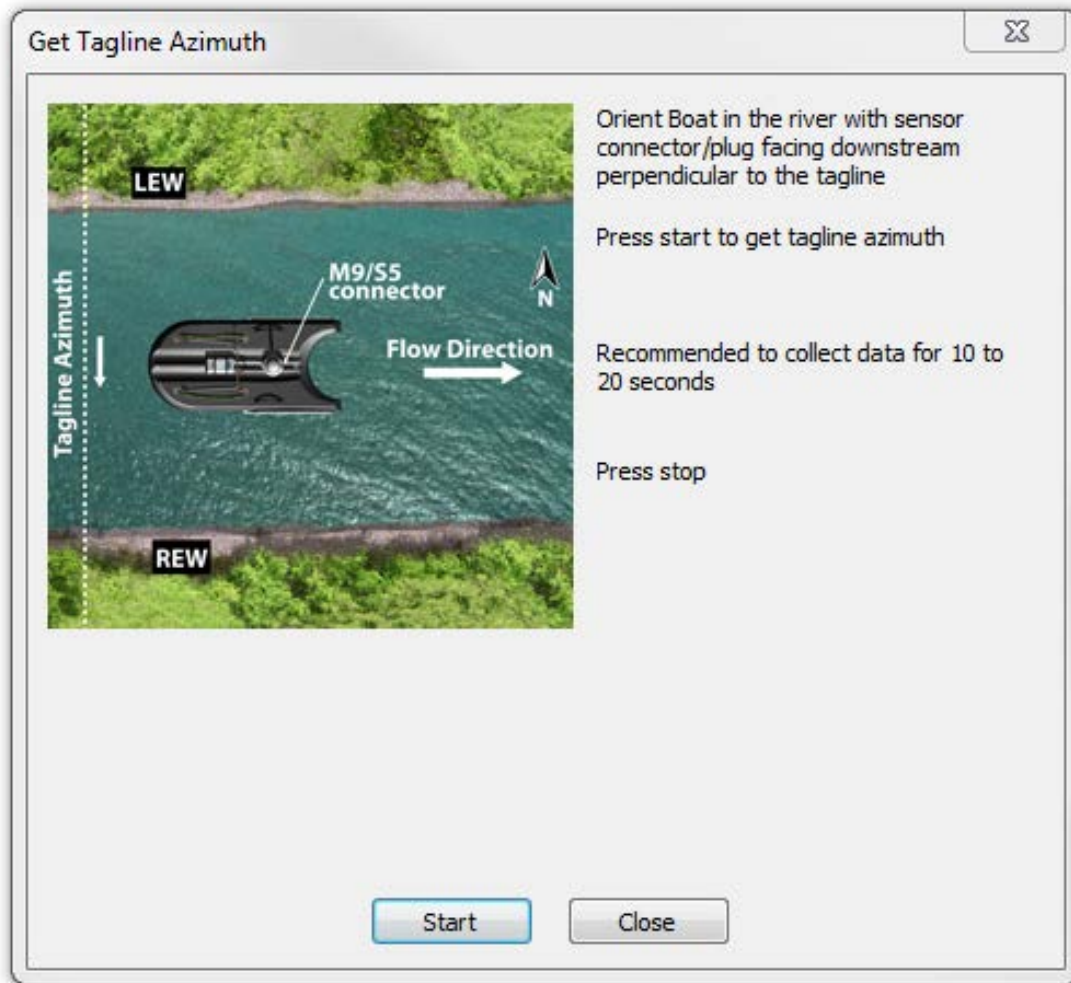

Figure 155. Get Tagline Azimuth Start

Follow the simple procedure outlined in the *Get Tagline Azimuth* dialog as follows:

1. Align the M9/S5 power and communications connector to point directly downstream. If you are deploying the instrument from a floating platform (i.e. boat, tri-hull, Hydroboard, etc...) then simply lower the boat into the water and allow it to align itself with the flow. This is typically best done in a location near the center of the river in a section of flow that flowing directly downstream.
2. Once the M9/S5 has been correctly aligned with the river and is relatively steady press **Start** to collect data. During this time the compass will display instrument heading at 1-second intervals, average instrument heading, computed tagline azimuth, and the number of samples (in seconds) as shown in Figure 156. After 10-20 seconds of data collection press **Stop** and close the dialog. The tagline azimuth field in the system settings dialog box will automatically be updated with the tagline azimuth measured using *Get Tagline Azimuth*.

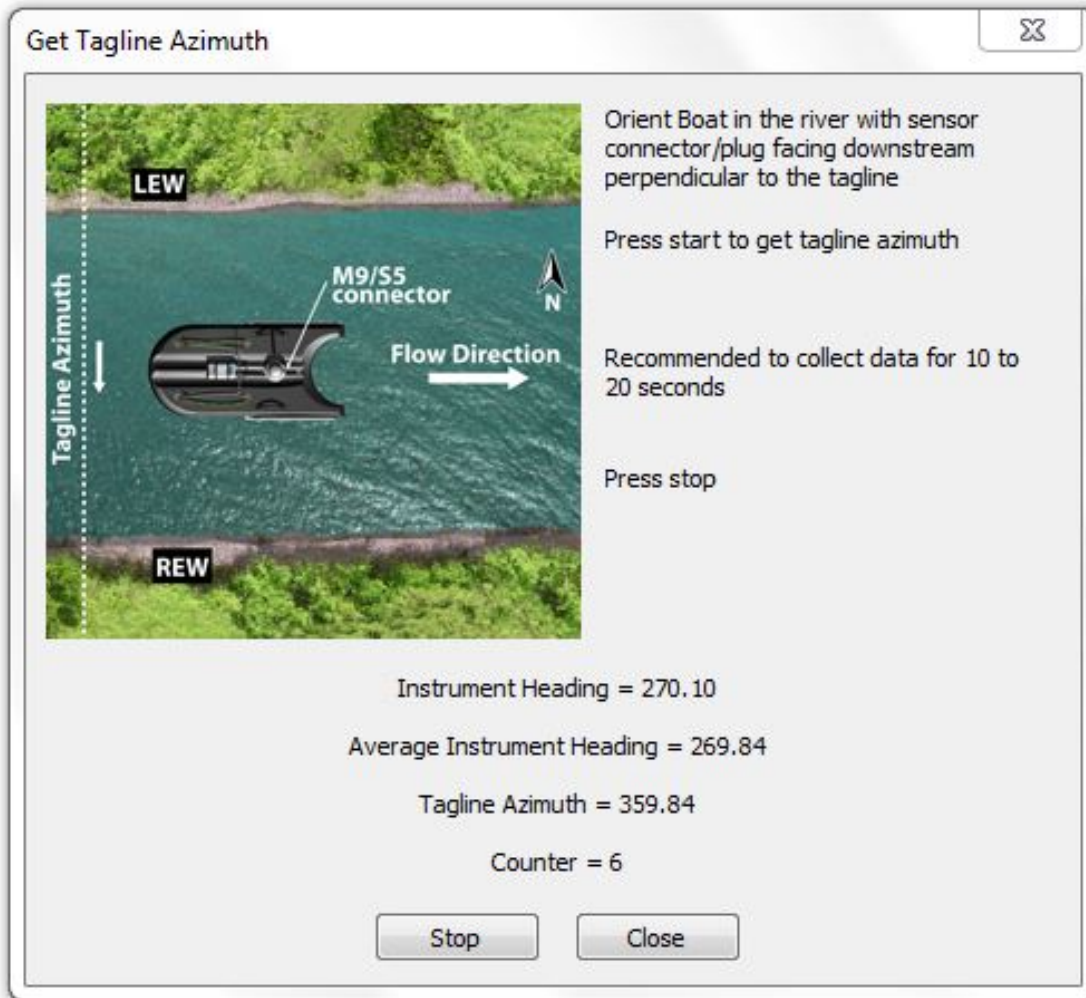

Figure 156. Get Tagline Azimuth Stop

Get GPS Projection Line: This setting is required if you use GPS for station positioning. You will not be able to use GPS if the GPS Projection Line is not set up. The projection line is the line over which your measurements will be taken. All GPS coordinates will be projected to this line, and a discharge value will be calculated accordingly. To set up a GPS Projection Line, click the Get GPS Projection Line button. You will see the dialog shown in Figure 157.

Get Projection Line
✕

The Start Location should be closer to the Start Edge
The direction of measurement for Start to End Location should be the same direction used for Start to End Edge

Start Latitude (deg)	<input type="text" value="0.0"/>
<input type="button" value="Get Start Location"/>	
Start Longitude (deg)	<input type="text" value="0.0"/>
End Latitude (deg)	<input type="text" value="0.0"/>
<input type="button" value="Get End Location"/>	
End Longitude (deg)	<input type="text" value="0.0"/>
Satellites	<input type="text" value="0"/>
GPS Quality	<input type="text" value="0"/>
HDOP	<input type="text" value="0"/>
Counter	<input type="text" value="0"/>

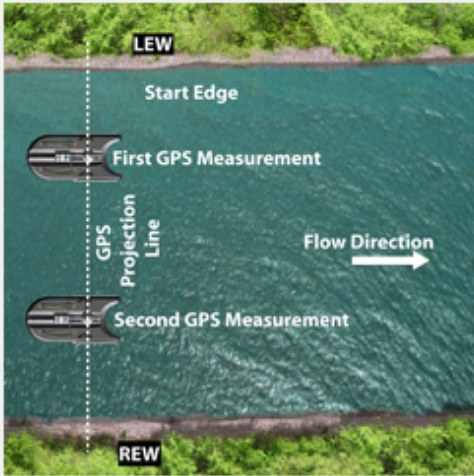

Figure 157. Get GPS Projection Line

You will need to record GPS location data at two points along your measurement line. The first point must be the point closest to your starting edge. Figure 158 shows the setup for taking the Projection Line points. The physical location of the projection line does not need to be exactly where the measurement will take place, although it must be parallel to your intended measurement line and nearby. For example, you can set your GPS Projection Line standing on a bridge if you are taking a measurement from a bridge, and then put your M9/S5 system in the water to take the measurement.

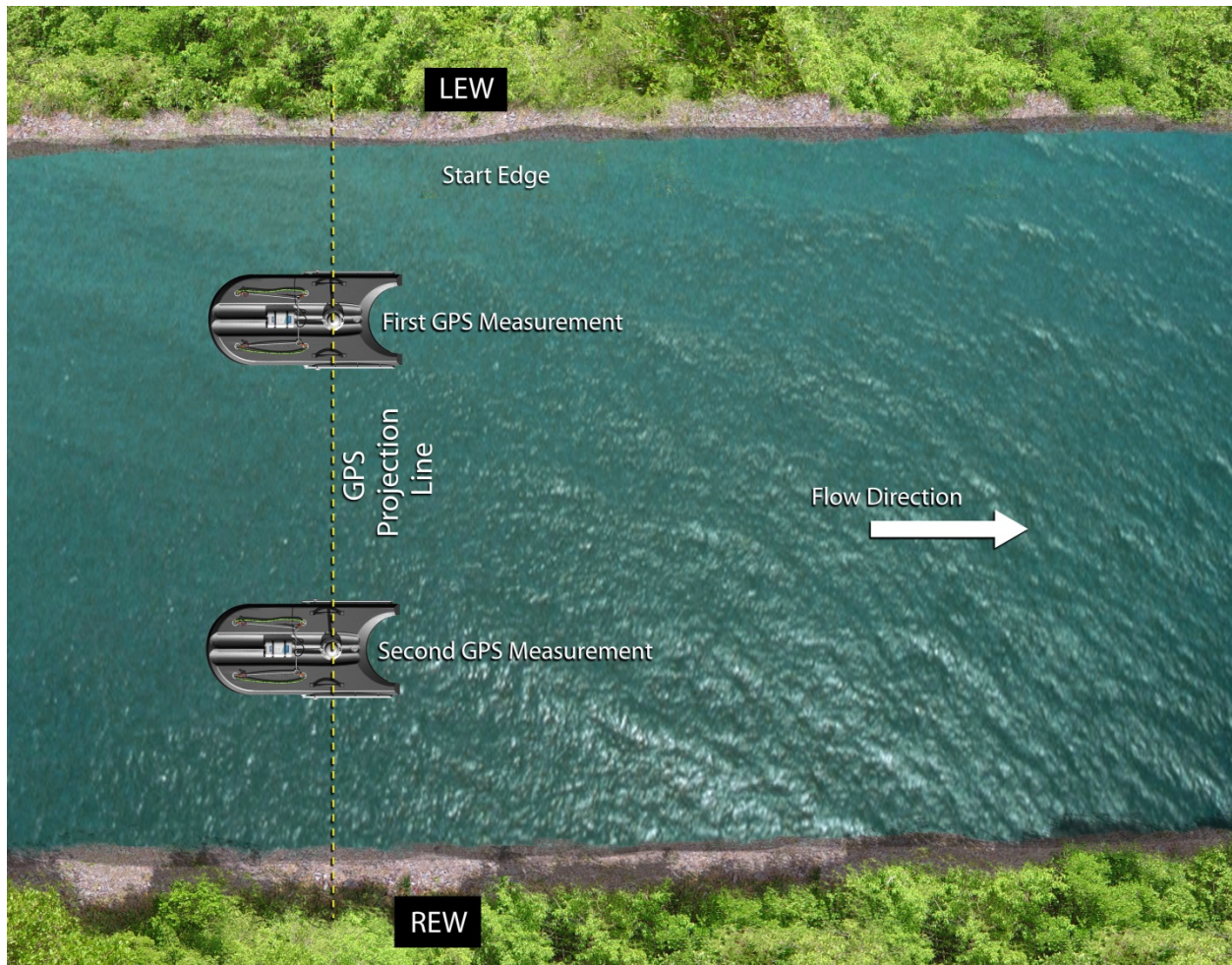

Figure 158. Get GPS Projection Line Setup

When you have your system in the location for the first GPS measurement, click **Get Start Location**. This will populate the Start Latitude and Longitudes. Then, move your system to the second GPS location and click **Get End Location**. The End Latitude and Longitude will be populated, as shown in Figure 159. You will also see some GPS metrics on the dialog, including the number of Satellites, GPS Quality, HDOP, and Counter.

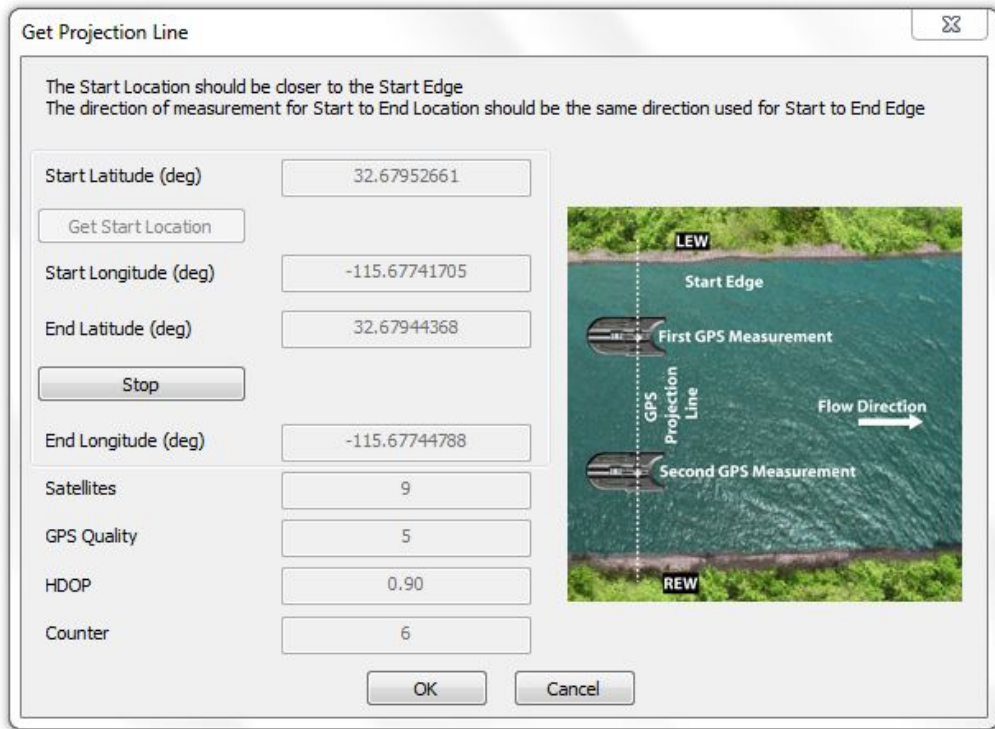

Figure 159. Get GPS Projection Line Coordinates

As mentioned earlier, the projection line is critical to be able to use GPS during the measurement. If there are issues with the GPS lock while getting the projection line, you will not be able to proceed, and will see “Waiting for DGPS or RTK Lock...” in the upper banner, shown in Figure 160. Once you have finished getting the Start and End Locations, click **OK**.

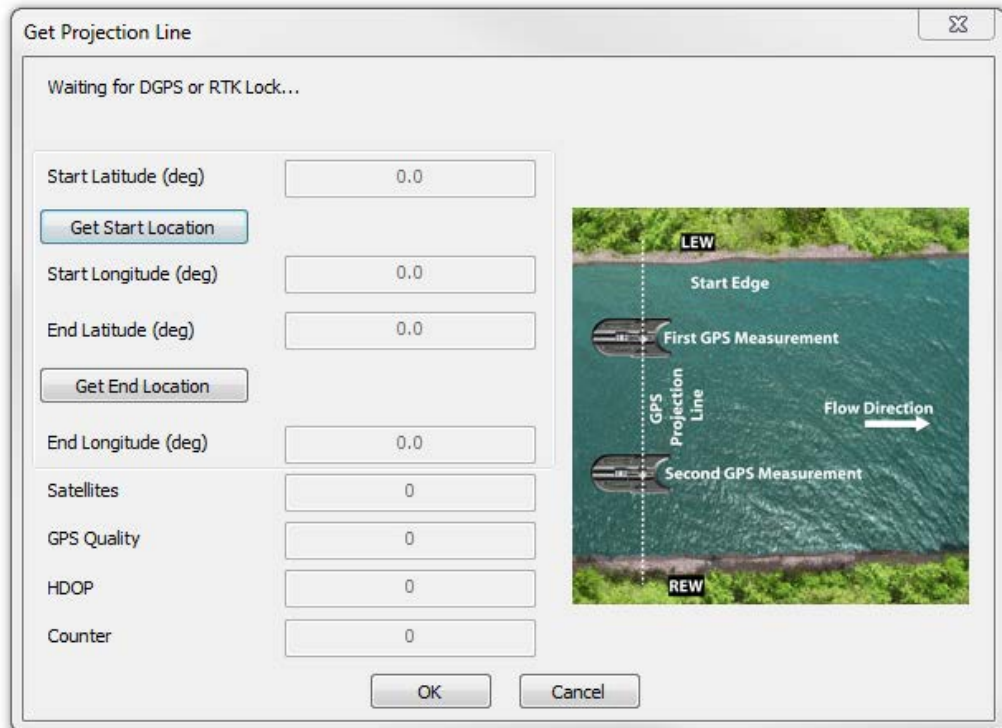

Figure 160. Get GPS Projection Line Setup

Salinity: Input the water salinity (psu) at the transducer face (example: freshwater = 0, sea water = 34.5 ppt).

The screenshot shows the 'System Settings' dialog box with the following configuration:

- Transducer Depth (m): 0.000
- Tagline Azimuth: 184.7 (with a 'Get Tagline Azimuth' button)
- Get GPS Projection Line: (button)
- Salinity (ppt): 0.0
- Track Reference: System (default)
- Depth Reference: Vertical Beam
- Discharge Method: Mid-Section
- SmartPulseHD™: Enabled
- User Input Sound Speed Correction:
 - Temperature (C): 15.0
 - Speed of Sound (m/s): 0.00
- Radio Transmit Power:
 - Low
 - Medium
 - High

Buttons at the bottom: OK, Cancel.

Figure 161. Salinity

Track Reference: Select either **System (default)** or **Bottom-Track** as a track reference. In most cases, because the M9/S5 is stationary during a measurement the *System* track reference will be preferred. Selecting *Bottom-track* as a track reference is also acceptable for discharge calculations; however, it will typically be used as a check against the stationary reference in post-processing for quality assurance purposes. In the case that the instrument is not perfectly stationary during the measurement, the Bottom-Track option will use bottom-tracking to correct for the boat movement. Both *System* and *Bottom-Track* reference data are recorded and can be changed in post-processing if desired.

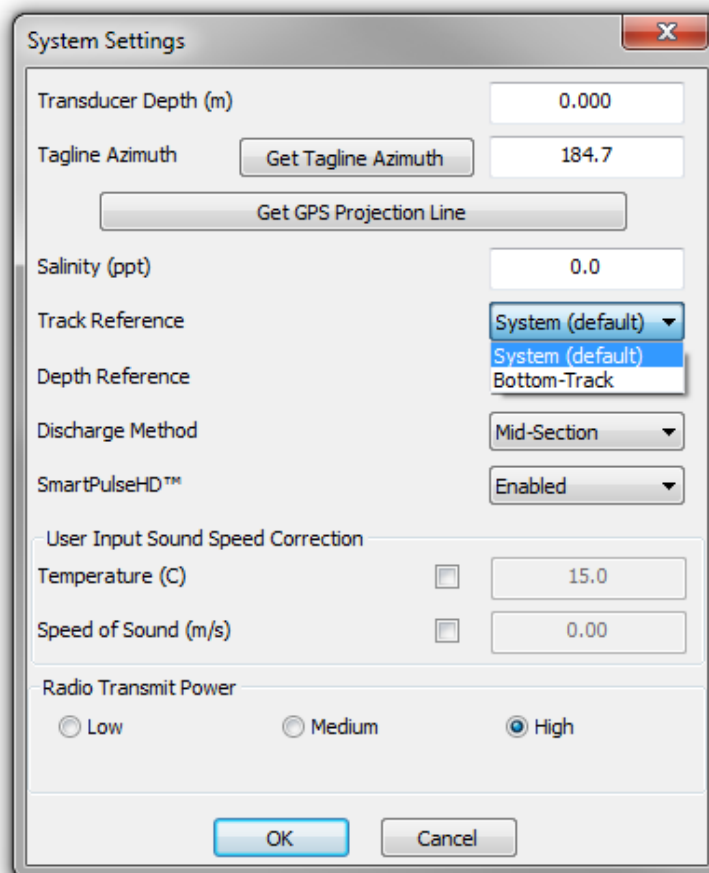

Figure 162. Track Reference

Depth Reference: Select either **Vertical Beam** or **Bottom-Track** as a depth reference. The M9/S5 measures depth using a center vertical beam as well as a 4-beam averaged depth. In most cases, the vertical beam will be preferred to provide a depth reading directly below the instrument. If the vertical beam depth measurement is not available, then the M9/S5 will automatically use the 4-beam *Bottom-Track* depth.

Discharge Method: Select either the Mid-Section or Mean-Section method for calculating discharge.

SmartPulseHD: Select whether to enable or disable SmartPulseHD. In most cases, you will want SmartPulseHD to be *enabled*. Disabling SmartPulseHD will force the M9/S5 into incoherent pinging mode and the system will not automatically select the best ping type for the measurement. Disabling SmartPulseHD should be used with caution and may affect your measurement quality.

User Input Sound Speed Correction: In the case where you would like to input a manual sound speed correct from an external temperature or sound speed probe, you can enable the fields by checking the box, and inputting the values from your external source. These values will be used to calculate velocity.

Radio Transmit Power: Select the radio transmit power. If you notice communications issues due to large distances between the Rover and your computer or difficulty getting a direct line of

sight between the two, increasing the radio transmit power can improve the quality of communications.

Once the System settings are configured, press **OK** to continue.

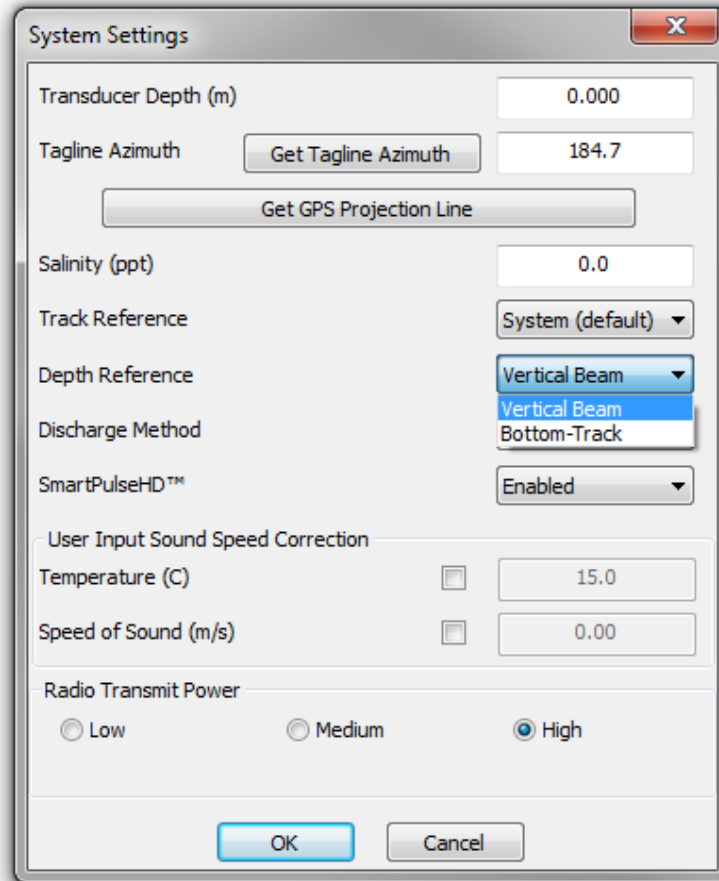

Figure 163. Depth Reference

G-8.5 Step 3: Quality Settings

Rated Discharge: The rated discharge used to calculate the percent discharge measured for each station. To input the rated discharge, click the update button and input the correct value. The percent measured discharge is used as a data quality parameter to assist in determining the correct width of a section.

Water Temperature (Independent): This is a separate water temperature from an independent source that can be recorded for quality monitoring purposes. This value is not used in any velocity calculations and is for the user reference only.

Measurement quality: This parameter is only available in post-processing (after opening a data file) and can be used to reference the quality of the measurement. The user can choose to qualify the measurement as Excellent, Good, Fair, or Poor.

G-8.6 Utilities

The Utilities section includes links to the Compass Calibration, Set Time, Beam Check, System Test, and Update Firmware. Please refer to Section 6.11 of the manual for a complete description of each.

G-8.7 Data Collection

To begin data collection, press the **Start a Measurement (F5)** button located towards the upper left-hand side of the screen. In order to prevent data loss in the event of a power, communications or computer issue during a measurement, the data file stored on the computer can be reopened to complete the measurement.

When using GPS, the system will record GPS data as long as a GPS lock is achieved. The user can select whether to use GPS at any station during the measurement, or to manually enter a location. Because the GPS data are always recorded, the user can decide to enable or disable GPS for any station in post-processing.

Start Edge (Station 1)

The *Start Edge* dialog box will open as shown in Figure 164. The Start Edge (Station 1) dialog will show several parameters, but only the relevant fields will be enabled in this step. Input the correct start bank (Left or Right), the starting location (edge of water on river bank measured from the tagline), the water depth at the start location (0 is typically used for a slope bank), velocity correction factor (1 is typical for most start and end locations), gauge height and auxiliary gauge height (i.e. water-level) if known, and the observation time of the gauge height reading.

When using GPS, **IT IS ESSENTIAL** that you place the M9/S5 at the edge of the bank for the Start Edge measurement, and not at the first measuring station! Position the M9/S5 at the edge and click **OK** to continue. If there is a GPS lock, the GPS location will be recorded at the Start Edge automatically, even though the Use GPS box is not active.

The 'Start Edge' dialog box contains the following fields and controls:

- Start Edge: LEW(left bank) (dropdown)
- Location from initial point (m): 0.00 (text input)
- Distance between stations (m): 0.00 (text input) with Use Gps
- Water Surface Type: Open Water (dropdown)
- Ice Thickness (m): 0.00 (text input)
- Water Surface To Bottom Of Ice (m): 0.00 (text input)
- Water Surface To Bottom Of Slush Ice (m): 0.00 (text input)
- Transducer depth below ice (m): 0.000 (text input)
- Transducer depth below water surface (m): 0.000 (text input)
- User Input Water Depth (m): 0.00 (text input)
- Screening Distance (m): 0.00 (text input)
- Coordinate System: ENU (dropdown)
- Averaging Time: 40 (text input)
- Velocity Correction Factor: 1.00 (text input)
- Gauge Height (m): 0.000 (text input)
- Auxiliary Gauge Height (m): 0.000 (text input)
- GH Observation Time: 2:44:35 PM (time selector)
- Island Edge: (checkbox)
- Buttons: Profile Extrapolation, OK [Enter], Cancel

Figure 164. Start Edge

Press the **Cancel** button to return to the system settings page and review the current system and data collection settings.

First Measured Station (Station 2)

Once the fields are updated press the **OK (Enter)** button. The station dialog will automatically open.

To use GPS at this station, simply check the **Use GPS** box in the dialog. If this box is not active, it means that for this station and the previous station, there was no GPS lock. As a reminder, the projection line must also have been performed in the setup; otherwise this box will also be inactive for the entire measurement.

When Use GPS is enabled, the values for **Location from initial point** and **Distance between stations** will update every second to provide real-time positioning information. Again, you will not need to use a measuring tape tag line to perform a Stationary measurement using GPS. As long as you have a GPS lock, the GPS will tell you the distance the system has moved. Move the system to a new station while using the updated location values as a guide. Once you are satisfied with the position of this station, continue below. If you choose not to use GPS at this

station or do not have a GPS lock, you must manually enter the location or distance between stations and move your system to that location by using a measuring tape.

The following is a brief description of each field in the station dialog:

Location from initial point: Distance from start bank (or reference point) using tagline.

Distance between stations: Distance between this station and the last station.

User Input Water Depth: Only required if M9/S5 depth measurement is not available.

Water Surface Type: Open Water, Ice Cover or Ice + Slush.

Ice Thickness: Enabled when Water Surface Type is Ice or Ice + Slush.

Water Surface to Bottom of Ice: Enabled when Water Surface Type is Ice or Ice + Slush.

Water Surface to Bottom of Slush Ice: Enabled when Water Surface Type is Ice + Slush.

Transducer depth below ice: Enabled when Water Surface Type is Ice or Ice + Slush.

Transducer depth below water surface: Depth of instrument below water surface. If Water Surface Type is Ice or Ice + Slush, this field is automatically recalculated to reflect ice thickness settings above.

Screening Distance: This is the distance below the water surface that you want to start collecting data rather than relying on the default setting of the instrument. In essence this setting allows you to program the ADP to start collecting data below a certain point. This is primarily used for boat mounted applications where the screening distance can be set to avoid flow disturbance from the wake of the boat. Note: An accurate Transducer Depth is required.

Screening Distance = Transducer Depth + depth to screen below instrument.

Coordinate System: ENU or XYZ. ENU enables compass and references measurements from magnetic north. XYZ disables compass and references measurements from the internal system axis. Coordinate reference can be changed on a station by station basis if required.

Averaging Time: Time (in seconds) over which data will be collected and averaged for each station. Longer averaging times in general tend to better represent a true mean discharge in the river. For example - USGS recommends minimum 40-seconds.

Velocity Correction Factor: 0 – 1. Value of 1 is most common. Please refer to your agencies' guidelines for reducing this factor.

Gauge Height: Observed water level from a known datum at your measurement location. Not required for data collection.

Auxiliary Gauge Height: Second water-level reference measurement from a similar datum. Not required for data collection.

Island Edge: Select to insert an island in the measurement section. Choosing this option once creates an island start edge. The software will require the next station to be an island end edge. More details on the Island Edge setting can be found at the end of this section.

The screenshot shows the 'Station 2' dialog box with the following fields and values:

Location from initial point (m)	1.37
Distance between stations (m)	1.37
Water Surface Type	Open Water
Ice Thickness (m)	0.00
Water Surface To Bottom Of Ice (m)	0.00
Water Surface To Bottom Of Slush Ice (m)	0.00
Transducer depth below ice (m)	0.000
Transducer depth below water surface (m)	0.100
User Input Water Depth (m)	0.00
Screening Distance (m)	0.26
Coordinate System	ENU
Averaging Time	40
Velocity Correction Factor	1.00
Gauge Height (m)	0.000
Auxiliary Gauge Height (m)	0.000
GH Observation Time	12:13:55 PM

Additional features include a 'Use Gps' checkbox (checked), a graphical display of the water column on the right showing 'Water' and 'Bottom' layers, and buttons for 'Profile Extrapolation', 'Measure [Enter]', 'Cancel', and 'End Edge'.

Figure 165. Station Dialog

Once the M9/S5 is in position, enter all relevant information into the appropriate field. On the far-right side of the station dialog is the graphical display of the vertical water column for the Station. This graphical display is known as the **Station Dialog** and is visible for all stations.

Measurement Tip: When the Station dialog first opens, the instrument will also start “Pinging” showing you the SNR (signal to noise ratio) profile plot for each beam and the number of valid cells for measurement (as shown in Figure 166). This information is provided to help make a better determination of the measurement quality. In addition, once the measurement is complete the system continues “Pinging” and displays this data as you move it to the next measurement location. Typically, it is recommended that you have a minimum of 2 valid cells and that the SNR profile plot shows the beams are measuring similar depths and are not obstructed by something below the water surface.

Press the **Measure** button to begin collecting data, **Cancel** to go back to review the measured station information, or **End Edge** to input the end edge location information. If you press Cancel to go back, you must press Next Station (F5) in the lower left-hand corner of the window to proceed with the measurement. If Use GPS is enabled, the GPS data collected over the entire station measurement will be averaged.

Data Collection Screen

Once the **Measure** button has been pressed, the station data will be displayed in 1-second intervals in the Data Collection Screen, as shown in Figure 166.

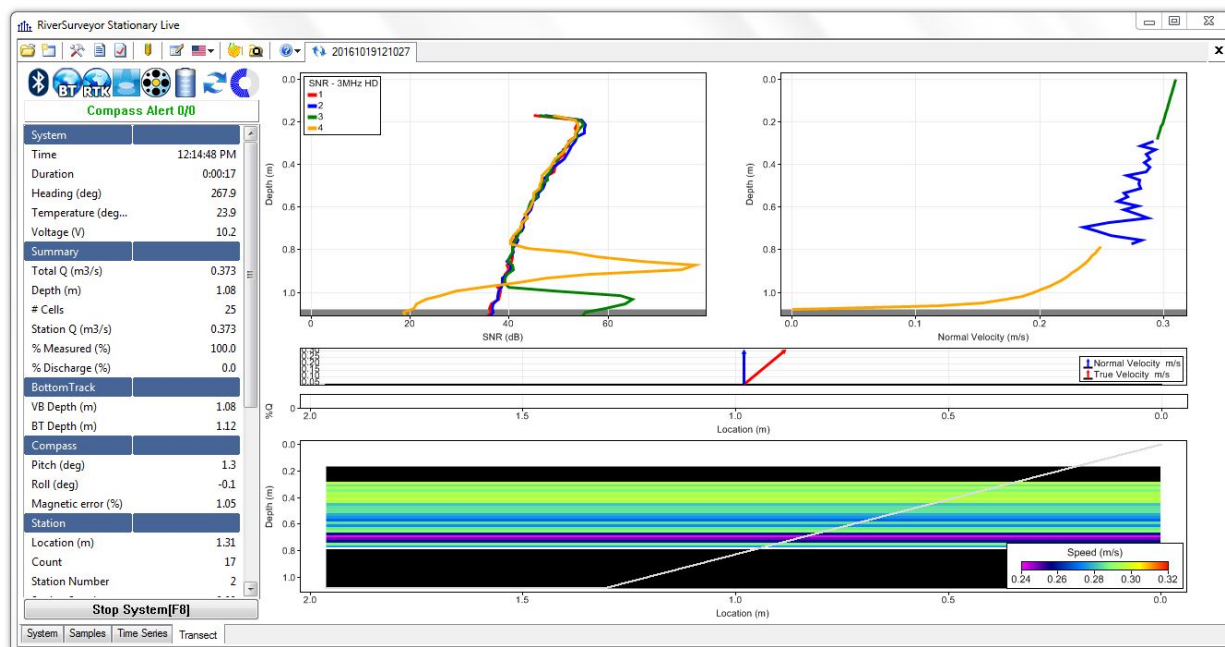

Figure 166. Station Measurement

While the station is being measured, you will see a few status icon changes in the upper left corner of the screen (Figure 167). The right-most icon shows a time counter during the measurement. To the left of that, blue arrows will rotate when the station is being actively measured. Other icons are the same as can be found in the RiverSurveyor Live software and are described in Appendix A.

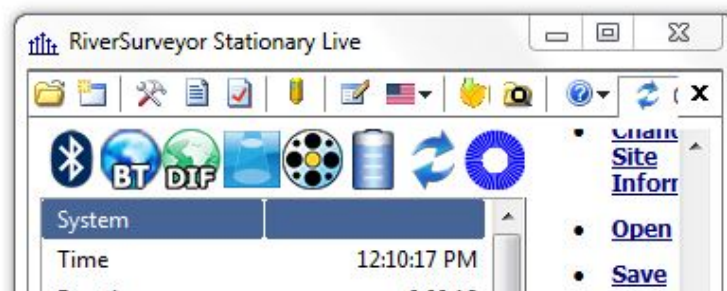

Figure 167. Status Icons during data collection.

A summary table is located below the icons to provide real-time and summary information for the particular station. The two profile plots at the top of the screen show the SNR (averaged signal-to-noise ratio) and normal velocity (averaged) by default and can be changed by right-clicking on the plots. During a typical measurement, these values are the most useful to monitor the performance and conditions. Below these is the vector velocity plot. Arrows representing the normal velocity measured for the station are shown. Right-click to toggle to the true (measured) velocity on the same plot. Below this is the Percent Discharge plot. If a Rated Discharge was entered in the System tab, the percent discharge at each station will be calculated based on the

Rated Discharge. The display will show colors indicating the percent discharge at each station (Green = <5%, Yellow = 5-10%, Red = >10%). The bottom plot shows the transect along the tagline with current Speed displayed in color. Although most people find the Speed display the most useful during a measurement, this can also be changed by right-clicking on the bottom plot itself.

Once a station measurement is complete, a Measurement Results dialog (shown in Figure 168) will automatically display a summary of the measurement. Review this information and then press **Accept** to proceed to the next station or **Repeat** to measure the same station again.

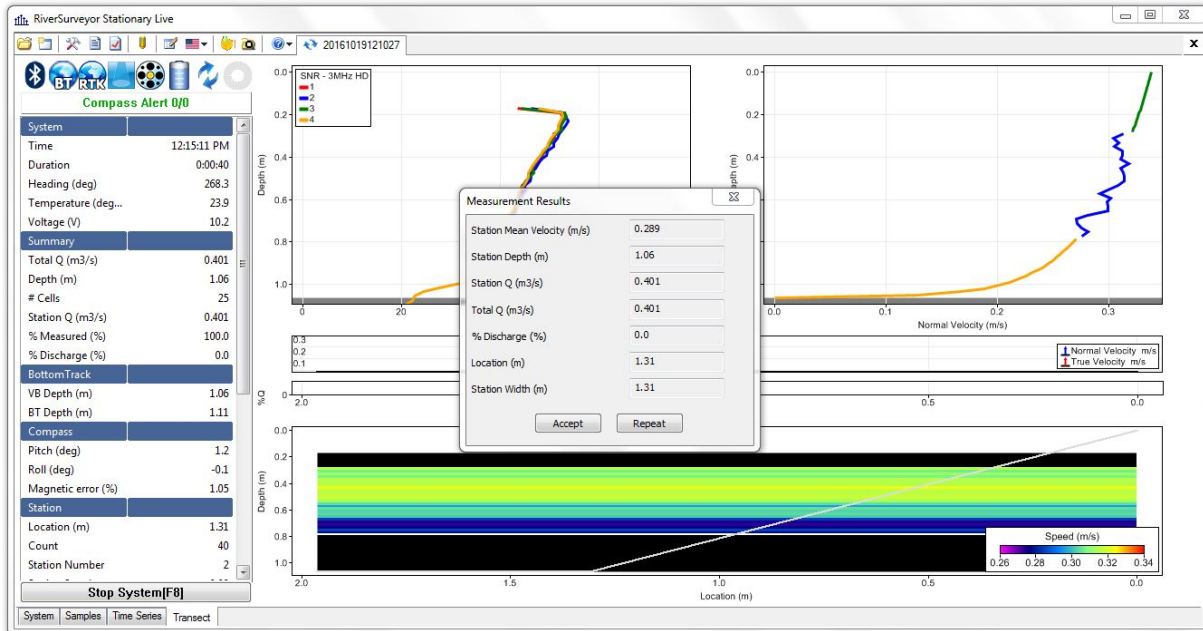

Figure 168. Measurement Results

Adding More Stations and Reviewing Stations

Once Accept is clicked, a Station Dialog box will automatically appear, prompting input for the next station. Duplicate the above process, measuring stations as needed for the entire transect. The user will have a choice at each station whether to enable or disable GPS.

To review previous stations already measured for reference, simply click **Previous** or **Next** in the **Station Dialog** (shown in Figure 169). When reviewing each station, the Measure button will be disabled. In order to re-measure at a station, please see the section called **Re-measuring a Station** below.

Station 6

Previous

Location from initial point (m) 4.75

Distance between stations (m) 0.61 Use Gps

Water Surface Type Open Water

Ice Thickness (m) 0.00

Water Surface To Bottom Of Ice (m) 0.00

Water Surface To Bottom Of Slush Ice (m) 0.00

Transducer depth below ice (m) 0.000

Transducer depth below water surface (m) 0.100

User Input Water Depth (m) 0.00

Screening Distance (m) 0.26

Coordinate System ENU

Averaging Time 40

Velocity Correction Factor 1.00

Gauge Height (m) 0.000

Auxiliary Gauge Height (m) 0.000

GH Observation Time 12:20:55 PM

Profile Extrapolation Measure [Enter] Cancel End Edge

Water

Bottom

Island Edge

Figure 169. Review Stations using Previous and Next Buttons

If you want to review your data before moving to the next station, press Cancel. You will be able to view data and information from the bottom left tabs as follows:

- **System Tab:** view the system settings that were input at the beginning of the measurement
- **Samples Tab:** You will be able to view information from each station in a tabular format. An example of the samples tab is shown in Figure 170. Through this tab, you will be able to edit stations by clicking the **edit stations** button for each station. This will bring up the Station Dialog, where you can edit the setup parameters for each station at any time. When editing stations, you can enable Use GPS or disable it and add a manual location. The GPS data from each station will be recorded if there is a GPS lock, regardless of whether Use GPS is enabled or not, so that the decision to use GPS can be changed for each station at a later time.
- **Time Series Tab:** The time series of various parameters can be displayed using this tab. To change what is displayed, right-click on each plot.
- **Transect Tab:** This tab shows the same plots that you see during each station measurement. Clicking on a station location in the bottom transect plot automatically changes the top profile plots to reflect data from that location (Figure 171).

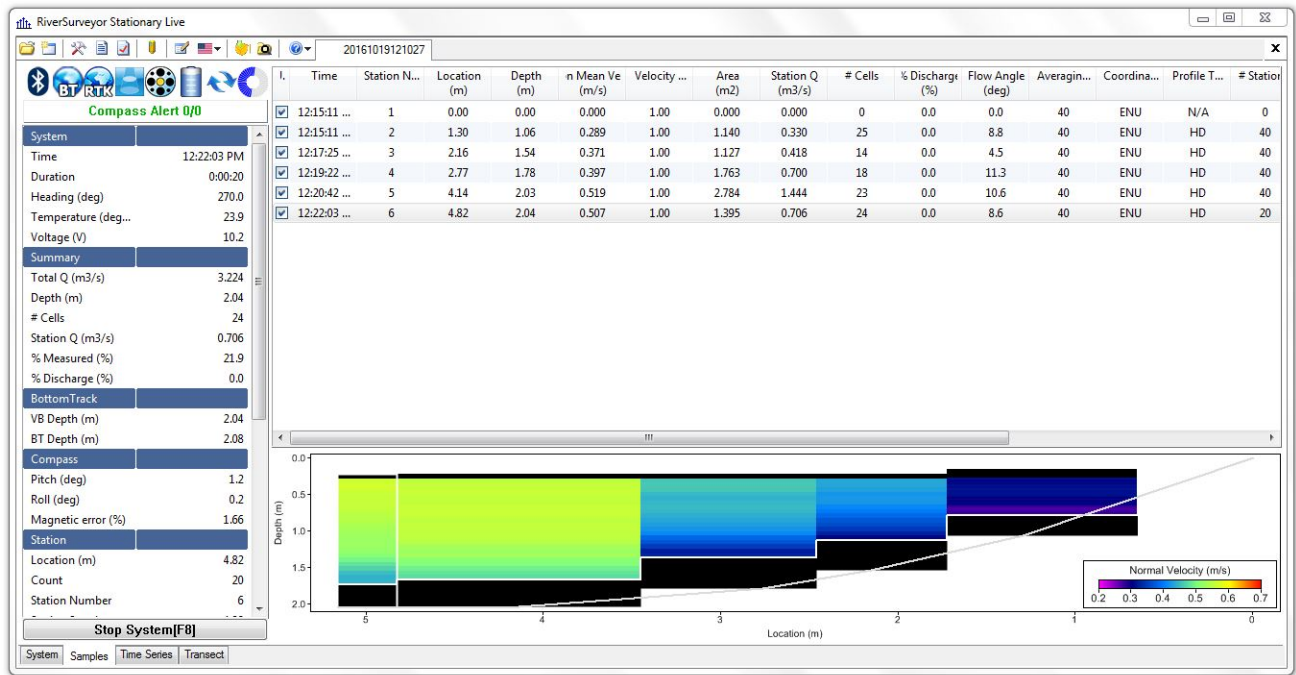

Figure 170. Samples Tab

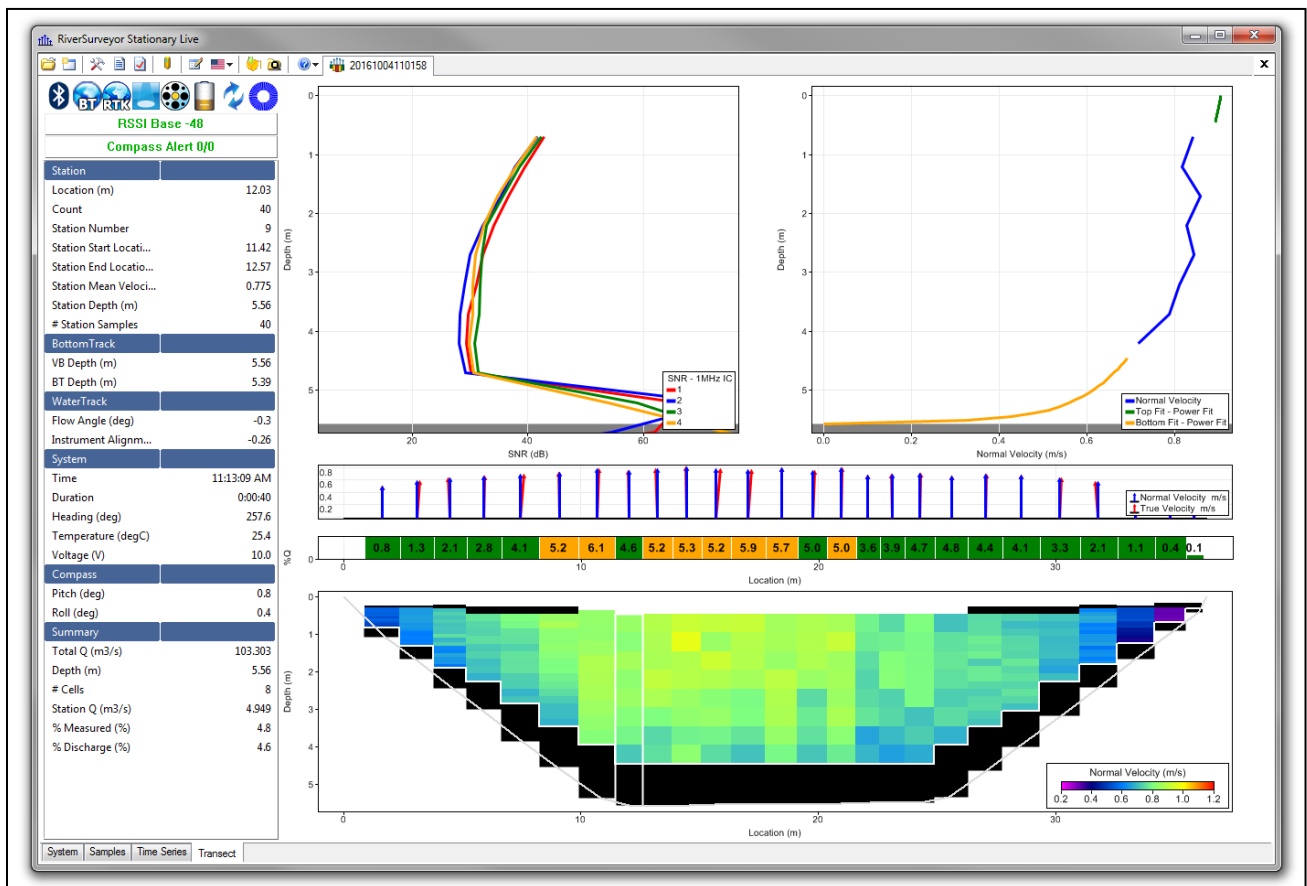

Figure 171. Data Collection Screen

Inserting a Station

The operator can insert a station at any time during the measurement. When using GPS, simply use the GPS updated location values to move the system to the desired location in between stations and click **Measure**. The GPS will automatically detect the location along your measurement line and insert the station accordingly. This can be done moving either forwards or backwards from your current position along your measurement line. If you choose not to use GPS to insert a station, the operator will enter a station location manually, and then click **Measure**. The inserted station will be sorted automatically and included in the total discharge calculation.

Re-measuring a Station

To re-measure a station, simply start a new station and move the system to the station that you wish to replace. Using GPS, the location should be detected automatically. Alternatively, you can manually enter the location. You will see a warning to replace the station, shown in Figure 172. Click **Yes** to re-measure at that station.

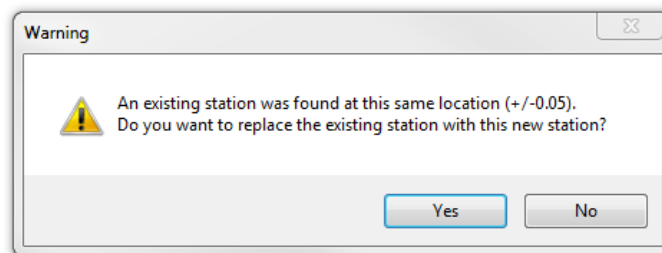

Figure 172. Re-measuring a Station

Island Edges

If a river is split into multiple channels, any internal island(s) must be accounted for in the discharge calculation. The stations at each edge of the internal island(s) are treated like the river edges.

The operator can click the **Island Edge** box at the bottom of the station dialog window. The window header will change from *Station* to *Island Start Edge* as shown in Figure 173. To use GPS to get the Island Edge location, simply toggle the Use GPS option and make sure your system sits on the Island Start Edge. You can also enter the location manually, if desired, by disabling Use GPS. Click **OK (Enter)** and the software will prompt the operator to enter *Island End Edge* information automatically before continuing to the next measurement station (Figure 174). Again, to use GPS to locate the Island End Edge, check the Use GPS option and place your system at the Island End Edge.

Island Start Edge
✕

Location from initial point (m)	<input type="text" value="3.00"/>		
Distance between stations (m)	<input type="text" value="1.00"/>	<input type="checkbox"/>	Use Gps
Water Surface Type	<input type="text" value="Open Water"/>		
Ice Thickness (m)	<input type="text" value="0.00"/>		
Water Surface To Bottom Of Ice (m)	<input type="text" value="0.00"/>		
Water Surface To Bottom Of Slush Ice (m)	<input type="text" value="0.00"/>		
Transducer depth below ice (m)	<input type="text" value="0.000"/>		
Transducer depth below water surface (m)	<input type="text" value="0.000"/>		
User Input Water Depth (m)	<input type="text" value="0.00"/>		
Screening Distance (m)	<input type="text" value="0.00"/>		
Coordinate System	<input type="text" value="ENU"/>		
Averaging Time	<input type="text" value="40"/>		
Velocity Correction Factor	<input type="text" value="1.00"/>		
Gauge Height (m)	<input type="text" value="0.000"/>		
Auxiliary Gauge Height (m)	<input type="text" value="0.000"/>		
GH Observation Time	<input type="text" value="2:55:15 PM"/>		

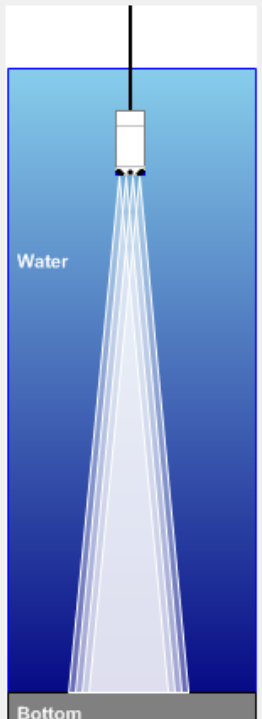

Island Edge

Figure 173. Island Start Edge

The screenshot shows the 'Island End Edge' dialog box with the following fields and values:

Field	Value
Location from initial point (m)	4.00
Distance between stations (m)	1.00
Water Surface Type	Open Water
Ice Thickness (m)	0.00
Water Surface To Bottom Of Ice (m)	0.00
Water Surface To Bottom Of Slush Ice (m)	0.00
Transducer depth below ice (m)	0.000
Transducer depth below water surface (m)	0.000
User Input Water Depth (m)	0.00
Screening Distance (m)	0.00
Coordinate System	ENU
Averaging Time	40
Velocity Correction Factor	1.00
Gauge Height (m)	0.000
Auxiliary Gauge Height (m)	0.000
GH Observation Time	2:56:06 PM

Additional features include a 'Use Gps' checkbox (unchecked), a 'Profile Extrapolation' button, and 'OK [Enter]' and 'Cancel' buttons. On the right, a diagram shows a transducer emitting a conical beam of light into a body of water, with labels for 'Water', 'Bottom', and 'Island Edge' (checked).

Figure 174. Island End Edge

End Edge and End Transect

When you have completed data collection of the last station, move the M9/S5 system to the edge of the bank, and press **End Edge** to input the ending edge location. As with the start edge, **IT IS ESSENTIAL** that while using GPS, the system must physically be on the end edge, and not at your last measuring station! Press **OK** to end the measurement. Once the measurement has ended you will not be allowed to insert any additional stations. Once all of the Stations and the End Edge have been entered, press the **End Transect** button to complete the measurement. The discharge summary report will be automatically generated and displayed. The software will close this file for editing at this time. To enable editing of the file, you must re-open the file.

G-9. Discharge Measurement Report

The Discharge Measurement Report is a formatted report-style summary of the current measurement. Click the Report button in the toolbar to display the Report.

The Summary is designed to be informative, easy to use and output the data in exactly the same format as it is entered.

If the report is too large for the monitor on your computer use the vertical scrollbar on the right to move the report up and down.

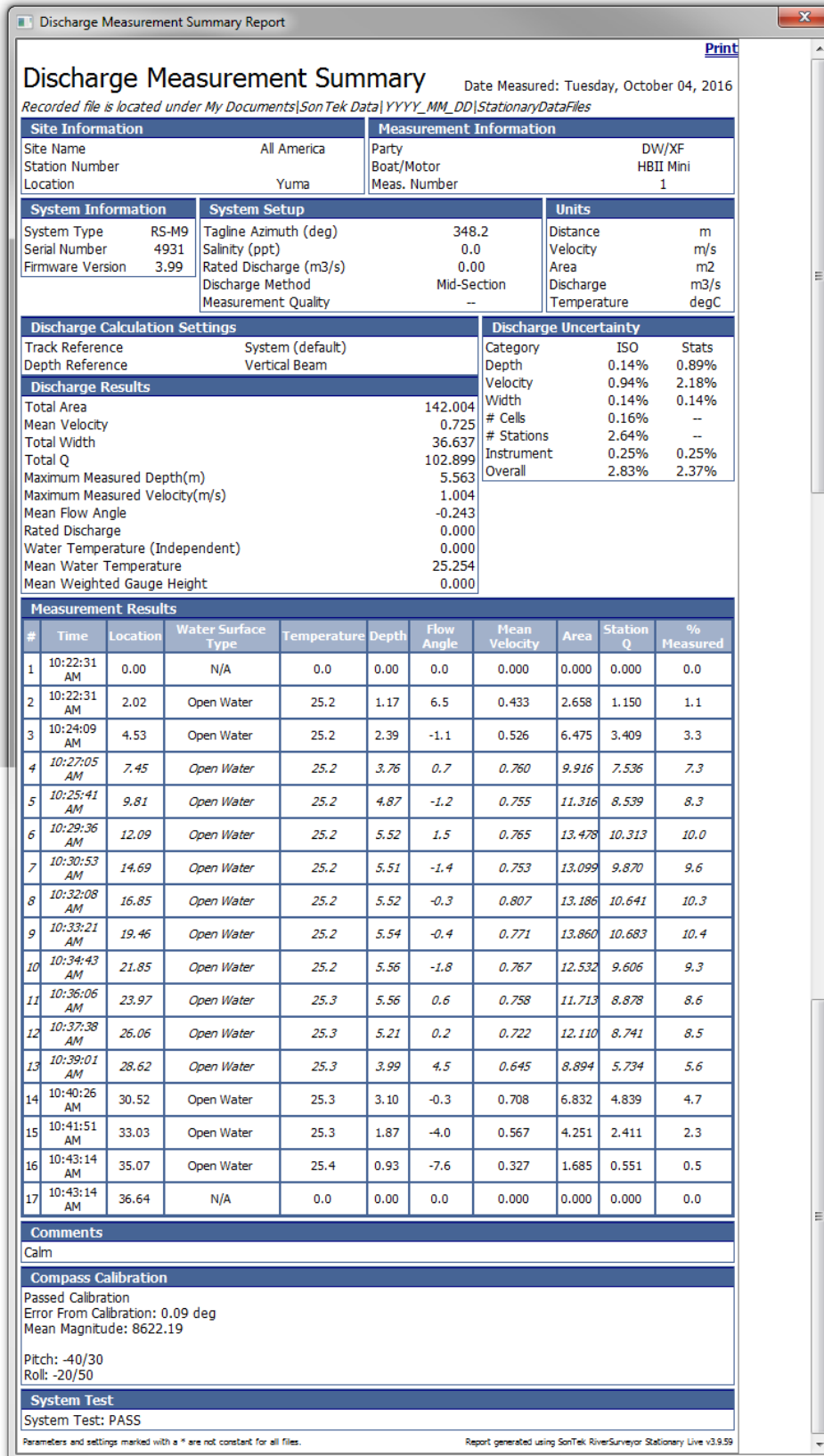

Figure 175. Discharge Measurement Summary Report

G-9.1 Discharge Uncertainty Calculation

The Discharge Measurement Report includes the estimated uncertainty of every discharge measurement. This calculation is done two different ways: Statistical or ISO.

- The **Statistical** (abbreviated **Stats**) uncertainty calculation uses a method developed by researchers at the U.S. Geological Survey. In general, this provides the most reliable indicator of measurement quality.
- The **ISO** method is based on the international standard and provides the results of a published, standard technique. In some cases, it may not provide as reliable an indicator of data quality, as it makes limited use of data from the site.

The uncertainty calculations are based on several different parameters. In addition to overall uncertainty, the calculation looks at the contribution of each parameter.

- Accuracy: the accuracy of RiverSurveyor velocity.
- Depth
 - In the **Statistical** calculation, this term includes both uncertainty in the depth measurement and the effect of changes in depth between stations.
 - In the **ISO** calculation, this term includes only the uncertainty in depth measurements.
- Velocity
 - In the **Statistical** calculation, this term includes both uncertainty in the velocity measurement and the effect of changes in velocity between stations.
 - In the **ISO** calculation, this term includes only the uncertainty in velocity measurements.
- Width: estimated uncertainty in width measurements.
- Method: estimated uncertainty from not measuring velocity throughout the entire water column (velocity near the surface and bottom must be estimated).
 - Used for the ISO calculation only.
- Number of stations: estimated uncertainty from measuring velocity and depth at a limited number of locations across the river.
 - Used for the ISO calculation only.

The Discharge Measurement Report shows both uncertainty calculations and the contribution of each parameter to the overall uncertainty.

Appendix H. Loop Method

Introduction:

The “Loop Method” is used for correcting discharges biased by a moving bed. The *RiverSurveyor Live* moving-boat software uses calculations and procedures documented in the USGS Scientific Investigations Report 2006-5079 by David S. Mueller and Chad R. Wagner, prepared with the cooperation of Environment Canada (<http://pubs.usgs.gov/sir/2006/5079/>). This USGS report describes in detail the procedures and techniques for collecting Loop Method field data and the proper calculations used to correct discharge for a moving-bed bias. The report also addresses the sources and magnitude of measurement uncertainty when performing this type of calculation. Based on field measurements from 13 locations the report concludes that when properly applied the Loop Method represents a valid alternative to the use of DGPS when measuring discharge in stream with moving-bed conditions. SonTek highly recommends that you review this document before applying the Loop Method to your data sets.

It should be noted: All computer code and output analysis used for this loop-method calculation was provided to SonTek/YSI, Inc. by the USGS Office of Surface Water (OSW). As such, moving-bed results provided using the existing MATLAB program (v4.03 or later) developed by David S. Mueller with the USGS OSW will produce identical results when computed using the *RiverSurveyor Live* software. The actual moving bed velocity calculation is based on the “distributed correction” method which is described in detail in the report mentioned above.

Background

For moving-boat discharge measurements, the RiverSurveyor M9/S5 measures boat speed using either bottom-tracking or an integrated DGPS system. Bottom-tracking requires that the riverbed be stationary (motionless) in order to properly compute boat-speed. During certain flow conditions, sediment will be transported along the riverbed (i.e. a moving-bed) and will produce a bias in the bottom-tracking results which will ultimately result in a biased discharge measurement. DGPS is a good alternative to bottom-tracking because it is not affected by the moving-bed.

In some instances, DGPS will not be available or reliable at your measurement site. As an alternative, when used properly the Loop Method can be used to correct the bottom-tracking bias produced by the moving bed.

The Loop Method is used to correct discharges that are biased by sediment transport (moving-bed) when bottom-tracking is used as a reference to measure boat speed. The basic premise is based on a “back and forth crossing closure error” where the apparent upstream movement of the ship-track is used along with the measurement time to determine the mean velocity of a moving bed. In this case, the discharge will be biased LOW by a certain percentage based on the velocity magnitude of the moving bed.

Loop Method Procedure

The Loop Method procedure described here follows explicitly the step-by-step procedure documented in the appendix section of the USGS Scientific Investigations Report 2006-5079 by Mueller and Wagner. SonTek/YSI recommends that this step-by-step procedure is reviewed prior to attempting a Loop Method measurement using the *RiverSurveyor Live* software.

The Loop Method can be performed using either the PC or mobile *Riversurveyor Live* software. The procedure is essentially identical. The only difference is the graphical screens available in the PC software. In addition, following the completion of the loop measurement results will only be available using the PC software.

Although moving-bed results are available prior to the discharge measurements to be performed, the actual “Loop Correction” will only be applied to discharge measurements in post-processing (if required). In addition, if the moving bed is determined to be insignificant it will not be possible to apply the correction to the processed data – this is in accordance to USGS procedures.

Step-by-step procedure

1. Start the *RiverSurveyor Live* PC or mobile software and connect to RiverSurveyor M9/S5.
2. Complete all steps on the SmartPage by starting at the top and working down. It is important that every step is completed to ensure accurate and reliable data collection.
3. The Loop method is available from either SmartPage or System tab in RiverSurveyor Live. The SmartPage is used when the Loop method is performed before a transect and the user is required to set “**Measurement Method**” on the SmartPage to “**LC and Moving Boat**”. System tab is used when the Loop method is performed after the transects or when only a Loop method is required.
4. Perform compass calibration on the SmartPage as described in previous sections in the manual. An accurate compass calibration is required to produce reliable results when performing a Loop Method.
5. Click on **Start LC Measurement** located on the bottom of SmartPage as shown in **Figure 176**. The instrument will begin profiling.

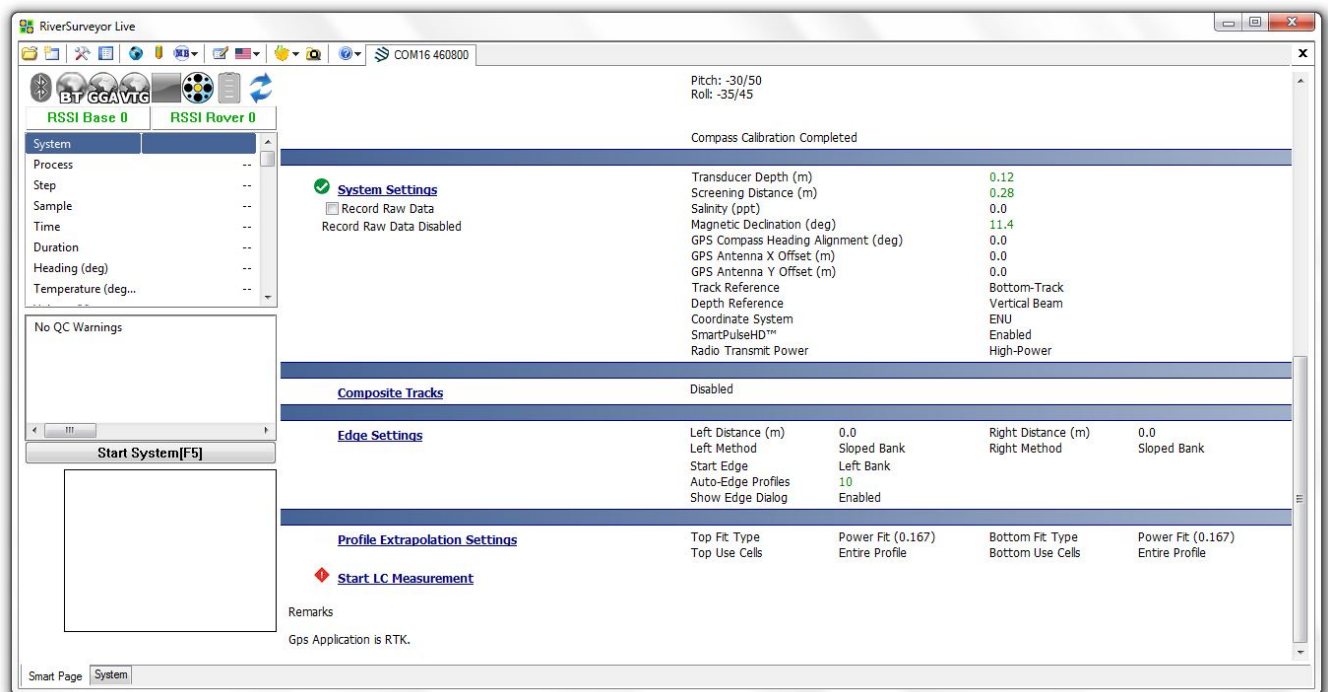

Figure 176. SmartPage - Loop Method

6. In the PC software, a Loop Method window will appear in front of the transect page as shown in **Figure 177**. Make sure the boat is stationary and located at your starting position. Press the **Start** button and proceed to make a steady pass back and forth across the stream. The Boat/Water ratio, Boat Speed, Ship-Track, Contour-Plot and Duration are displayed in the window.

It is essential to a quality measurement to maintain a uniform and steady boat speed during the entire measurement. Per the USGS recommendation, the boat speed should be the lesser of a.) the boat speed that requires no less than 3-minutes to complete the loop or b.) the boat speed that is less than 1.5 times the mean water speed.

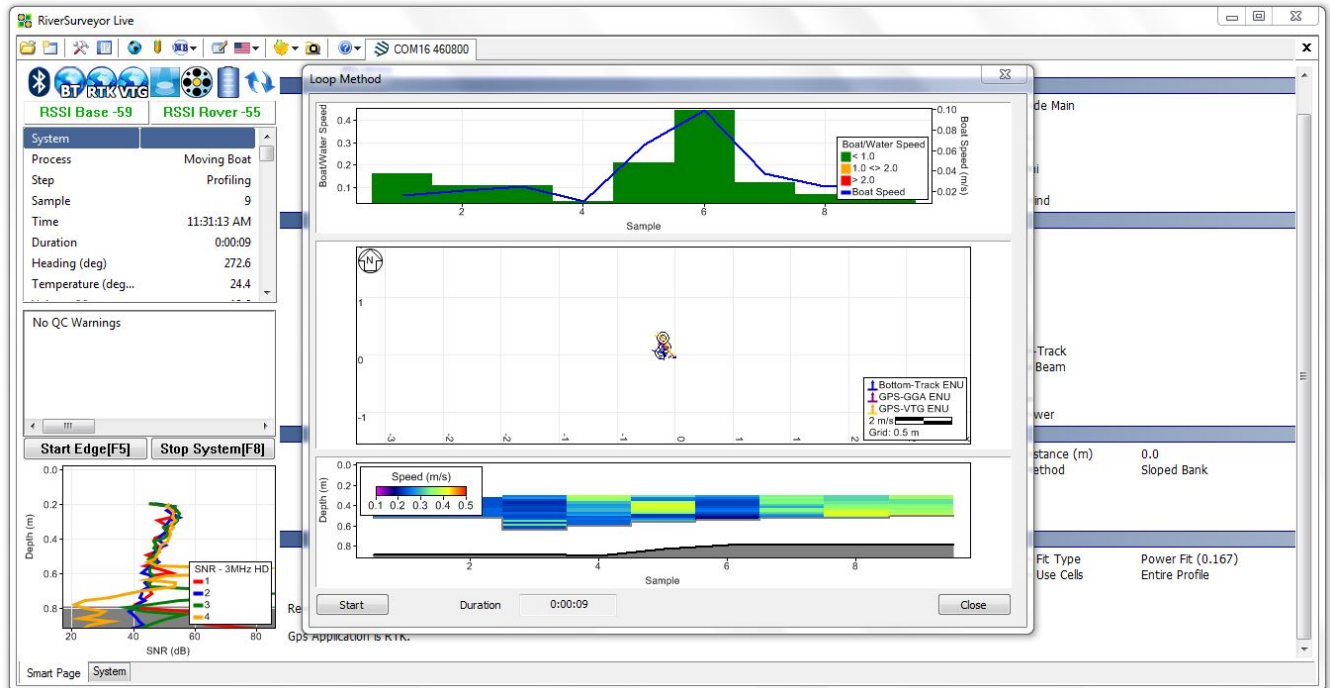

Figure 177. Start Loop Method

7. Establish a starting point near the bank. It will be helpful to select this location such that the boat can easily be controlled when starting and ending a measurement. The starting point does not need to be located as close to the bank as a regular discharge measurement.

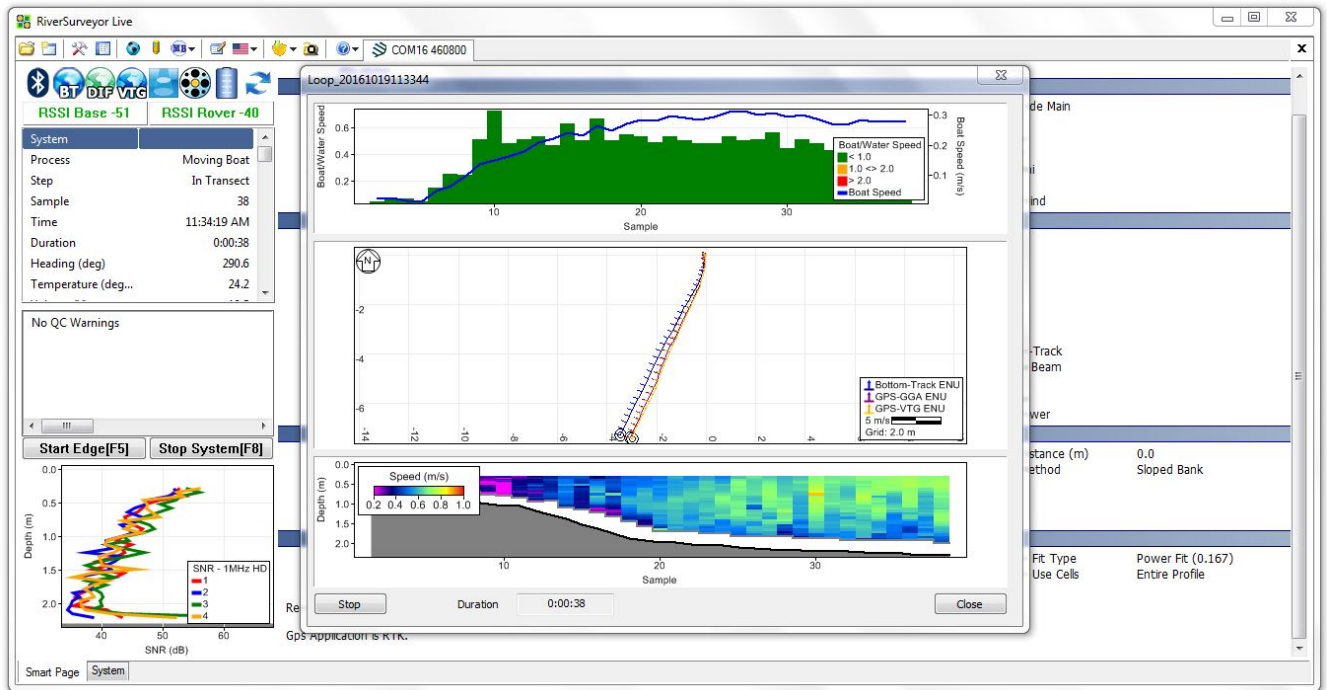

Figure 178. Starting point of Loop Method

8. When approaching the far channel bank, do not spend any extra time along the edge. Rather, gently turn the boat and return to the starting stream bank.

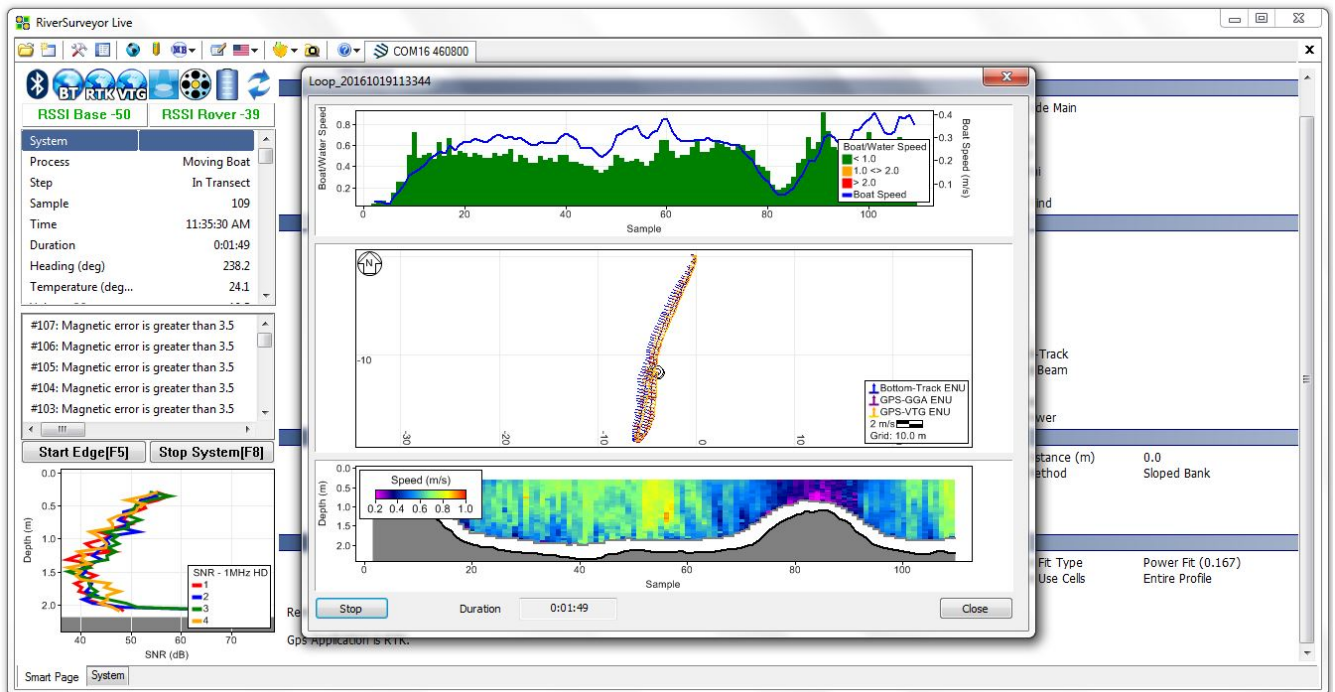

Figure 179. Far channel bank measurement process

9. It is important that you need to return to the same location as the starting point in order to determine accurate moving-bed speed, the greater the difference between the start and end locations, the greater the uncertainty in the Loop Method's results.

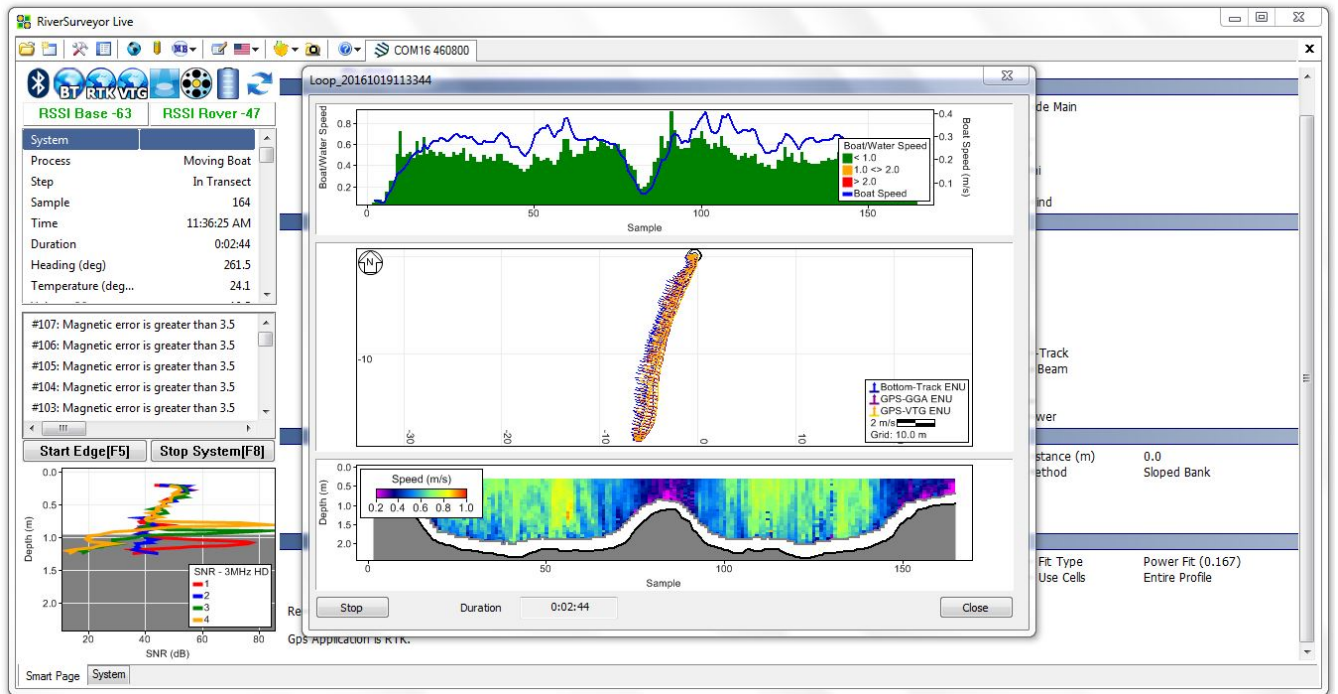

Figure 180. Stop Loop Method Measurement

After returning to the starting position and the boat is stationary, press the **Stop** button (Figure 180). There will be a slight pause as the loop calculation is performed.

10. The results will be displayed the PC software as shown in Figure 181. Press **Continue to Start Edge** to begin regular discharge measurements or **Repeat** to perform the Loop Method again

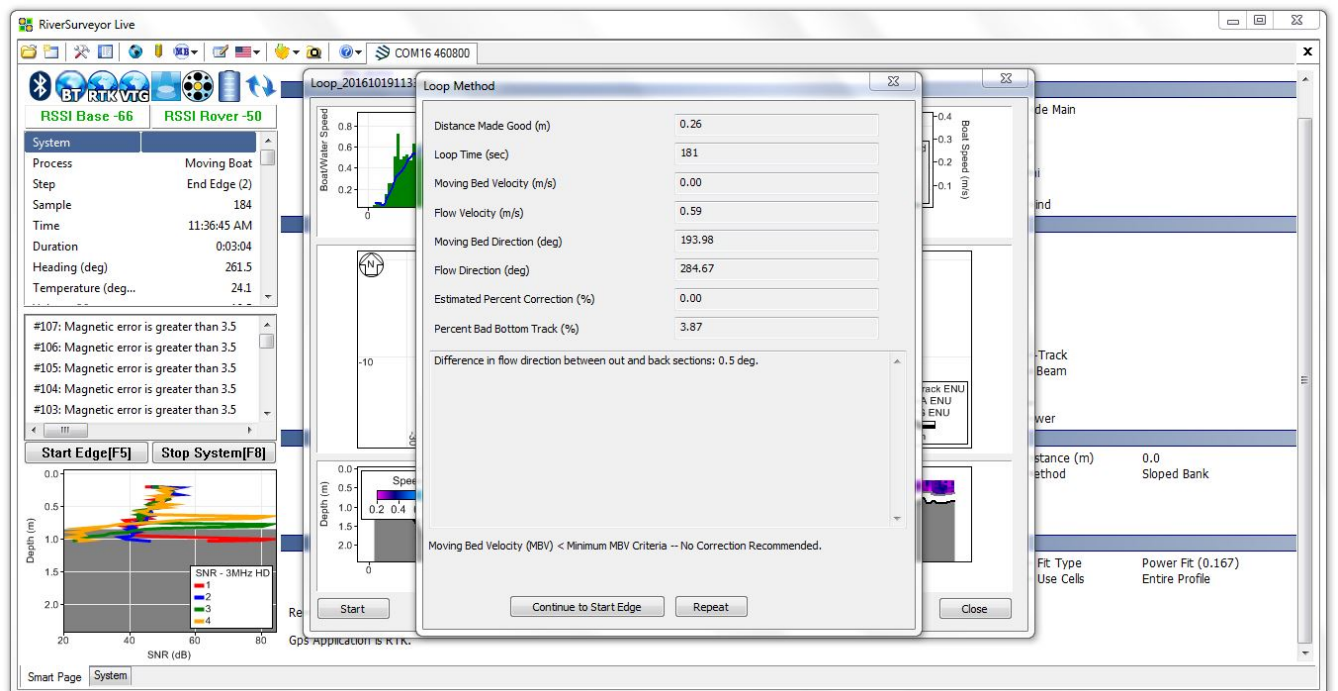

Figure 181. Loop Method Results

A Loop Method file will be stored on the M9/S5 internal recorder and on the PC or mobile device that will contain all data collected during the Loop Method measurement in addition to the moving-bed results. The file name will start with “Loop_” to identify it from a regular discharge measurement.

Post-Processing Loop Method Measurements

1. Start the *RiverSurveyor Live* PC software.
2. **Open** the regular discharge measurement files as usual.
3. Open the associated Loop Method file by clicking on the **LC** icon located on the top tool bar. Select the appropriate file associated with the regular discharge measurements to be processed. For data collected using firmware v1.50 or later, the loop file name will begin with the word “Loop_” as shown in Figure 182. For loop measurements made with earlier firmware versions, the file name will begin in the same format as the regular discharge measurements. It should be noted, this is the only way you can load a Loop Method file.

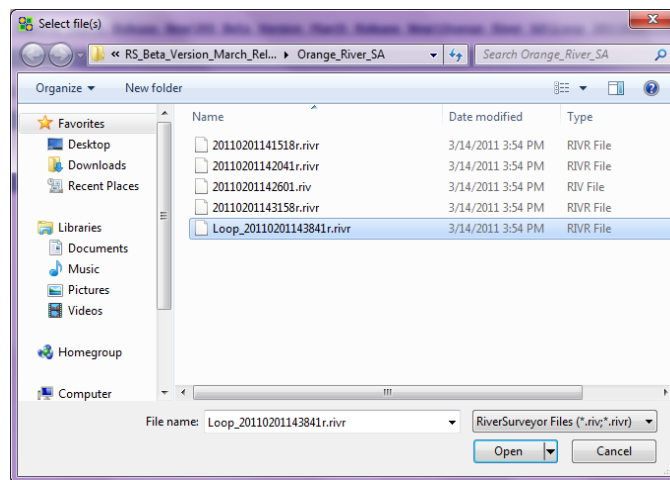

Figure 182. Loop Correction File

4. The Loop Method results will be processed and displayed as shown in Figure 183. Click **Close** after the results are reviewed.

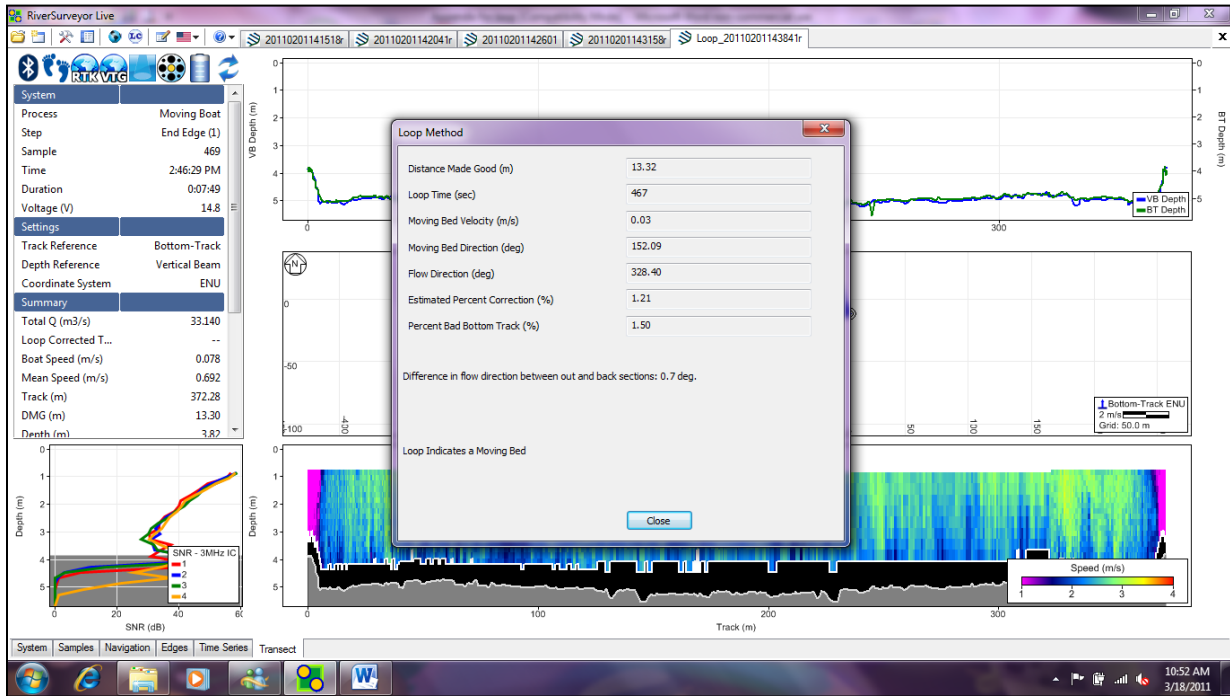

Figure 183. Loop Method Results

- The moving bed speed is now calculated. Prior to applying the correction, you must first open the Processing Toolbox by clicking the Tools icon (**Ctrl+T**) on the tool bar located at the top of the screen. It is also helpful to open the Discharge Summary (**Ctrl+S**) by clicking the summary icon located on the toolbar. The screen should appear as shown in Figure 184.

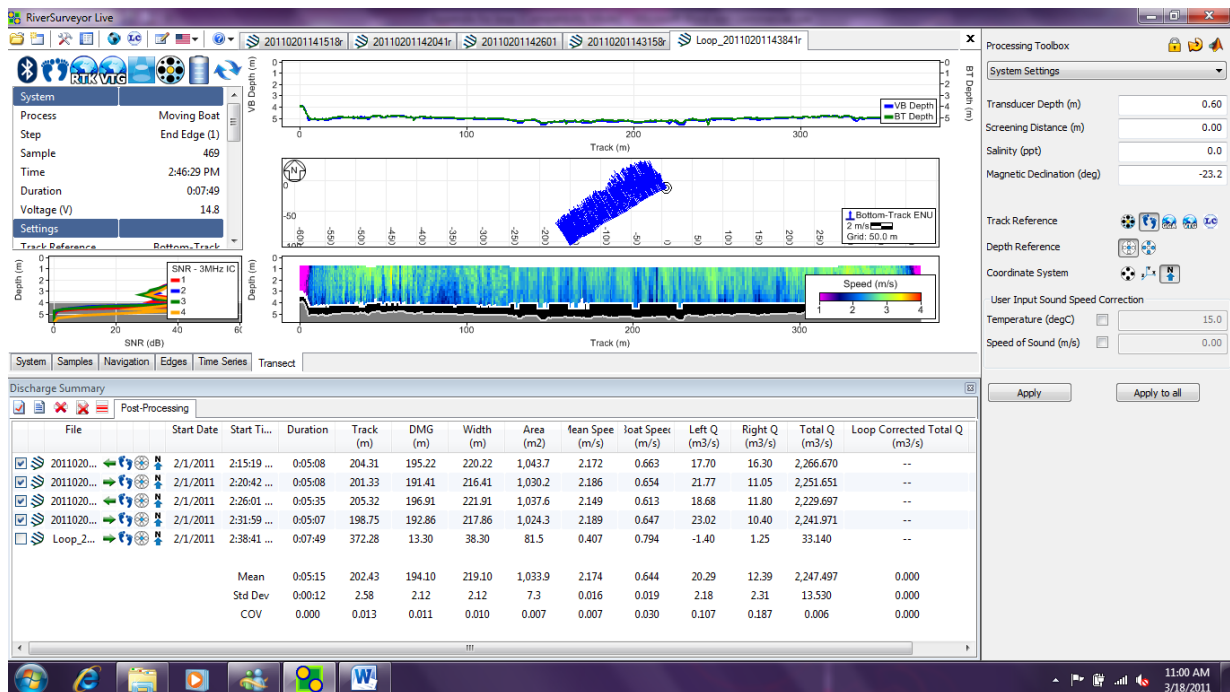

Figure 184. Loop Method Processing

- Click on the **LC** icon at the end of the Track Reference options in the Processing Toolbox on the right side of the screen. Click **Apply to all** to apply the loop correction to the open measurements. As soon as the correction (if valid) is applied, the Discharge Summary and the side bar summary table will update to show the “Loop Corrected Total Q” as shown in Figure 185:

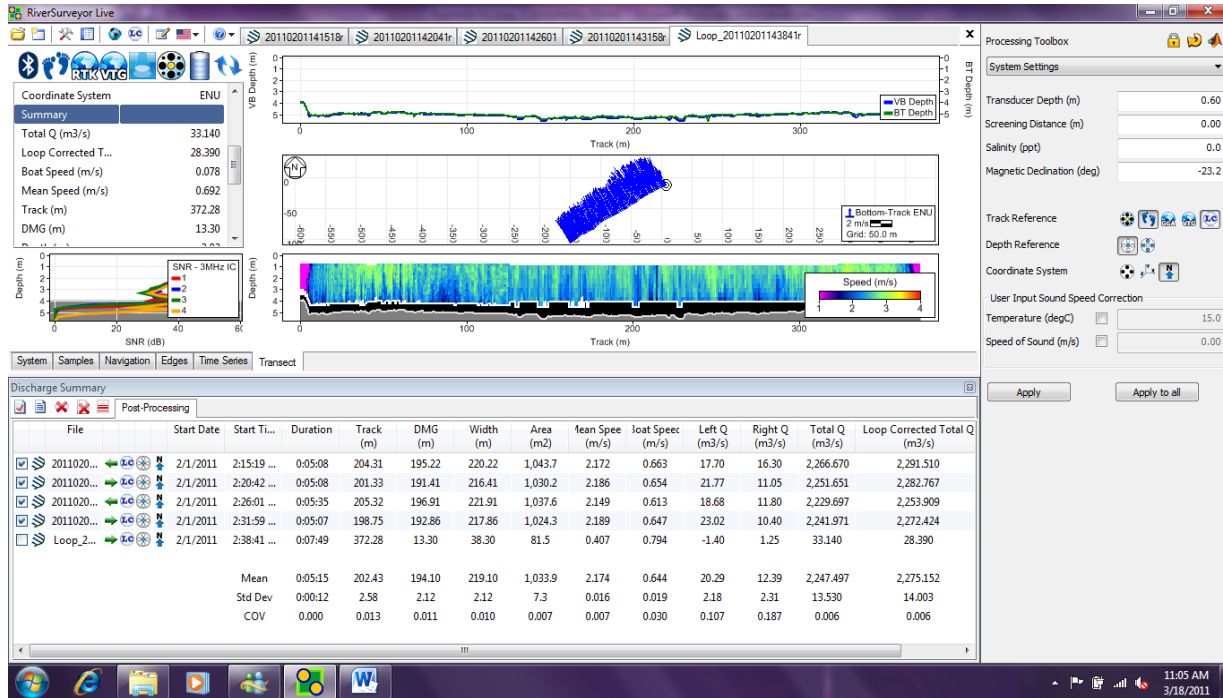

Figure 185. Loop Method Correction

- Click the **Discharge Summary Report** icon under the Discharge Summary table to generate the final discharge summary report. The final report will display the entire Loop Method analysis along with measured and loop corrected discharge values as shown in Figure 186:

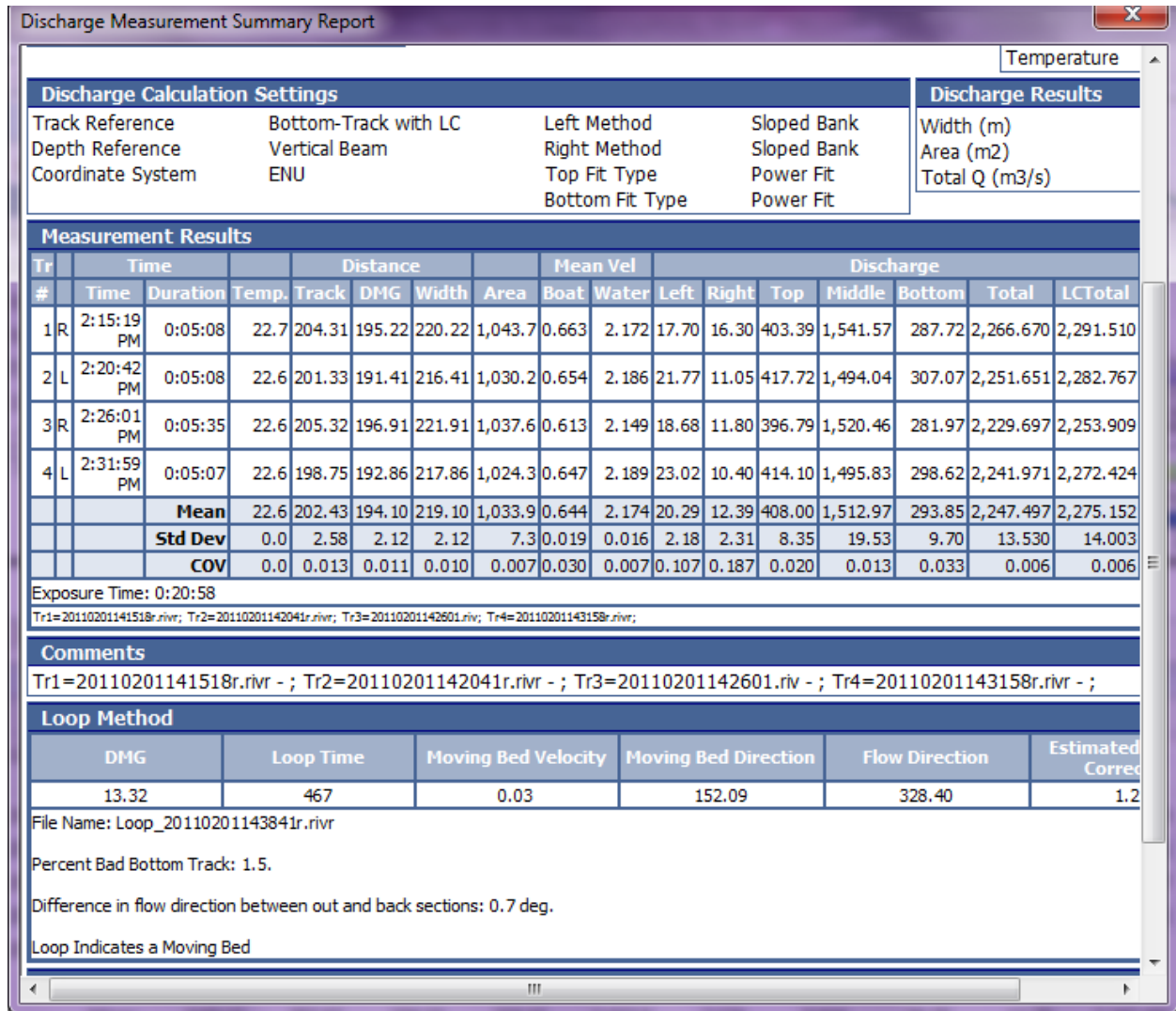

Figure 186. Discharge Summary Report

Appendix I. CastAway CTD Integration

Background - Sound Speed and Acoustic Measurements

Underwater acoustic measurements, particularly acoustic depth range measurements, are dependent on information about the speed of sound in the water to collect accurate data. Sound can travel through the water at different speeds based on changes in temperature, salinity and density (Table 9). For example, sound will travel faster in hot salty water and travel slower in cold fresh water.

	Change	Effect on Sound Speed
Temperature	1° C	4.0 m/s
Salinity	1 PSU	1.4 m/s
Depth	100 m	1.7 m/s

Table 9. Effect of temperature, salinity and depth changes on the sound speed in water

The water in almost every lake, river, estuary and ocean is stratified into different layers. Temperature conditions in one layer may be notably different from conditions in another layer (**Figure 187**). As sound transitions from one layer to the next it will also refract and change direction. These changes in sound speed and direction throughout the water column cause errors in acoustic depth measurements. Depth measurement errors are generally largest in deeper rivers or in estuaries where water temperature and salinity at the surface can vary significantly from the water beneath it. For more detailed information about how temperature and salinity affect depth calculations, refer to SonTek Technical Note: *Range, Velocity, Sound Speed and Snell's Law*.

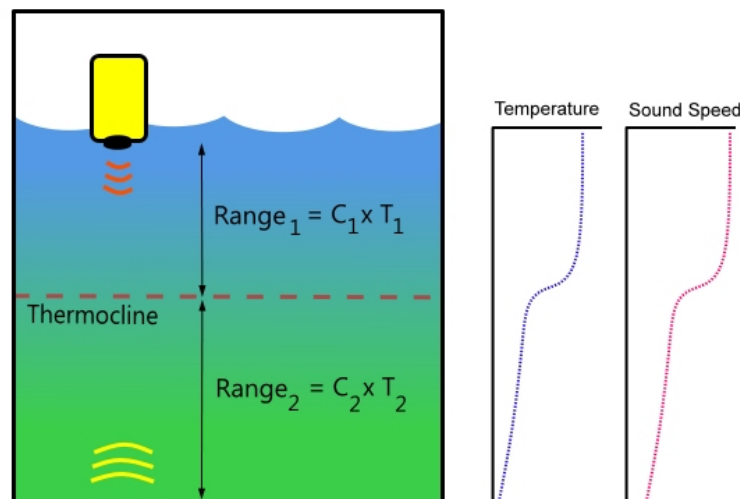

Figure 187. A Stratified Water Column

Similar to acoustic current measurement systems, hydrographic surveying instruments (i.e. multibeam echosounders, side scan sonar) measure the time it takes a sound pulse to travel from the instrument to the seafloor to calculate distance. Hydrographic surveyors apply sound speed corrections to their data to reduce depth measurement errors induced by sound speed variability. To measure sound speed, surveyors use a CTD (Conductivity, Temperature, Depth) sensor to collect a vertical sound speed profile during a hydrographic survey. The sound speed correction is then applied to the acoustic sounding data yielding more accurate depth measurements. These sound speed corrections can also be applied to ADP measurements to improve their accuracy.

Application to ADP measurements

While it has been common practice for hydrographic surveyors to apply sound speed corrections to bathymetric data, corrections have not commonly been applied to ADP data for two primary reasons. First, the advantage of higher accuracy measurements has been overshadowed by the complexity of applying corrections and velocity measurements are impacted less by sound speed than depth measurements. In many environments sound speed corrections will only slightly improve ADP measurement accuracy; however, there are environments such as estuaries where corrections will significantly increase accuracy. With growing requirements for highly accurate flow measurements in our rivers and oceans and with more ADP data being used for measurements other than velocity such as discharge and bathymetry, the need for applying sound speed corrections to ADP data is increasing.

Sound speed corrections improve the accuracy of ADP discharge calculations by increasing the accuracy of the river cross-sectional area. Accurate sound speed measurements at the ADP transducer face are important for velocity measurement accuracy. The fast response of the CastAway thermistor eliminates the need for waiting for the ADP thermistor to equilibrate to water temperature. Measuring temperature and conductivity at the surface allows for the most accurate sound speed equation to be used in the velocity calculations.

CastAway CTD and RiverSurveyor Integration

The CastAway is a small sophisticated CTD that provides a turnkey solution for applying sound speed corrections to RiverSurveyor measurements by integrating seamlessly with RiverSurveyor Live 3.0 and RiverSurveyor Stationary Live 2.0. Collecting sound speed profiles is simple with the CastAway: it can be lowered by hand, requires no preprogramming, and after a cast automatically transfers data to your PC. A built in GPS marks the location and timestamp of the sound speed profile and also allows the software to automatically select which profile to apply to the discharge calculation. In the software, there is also a summary page that displays temperature, salinity and sound speed information from the CastAway (Figure 188).

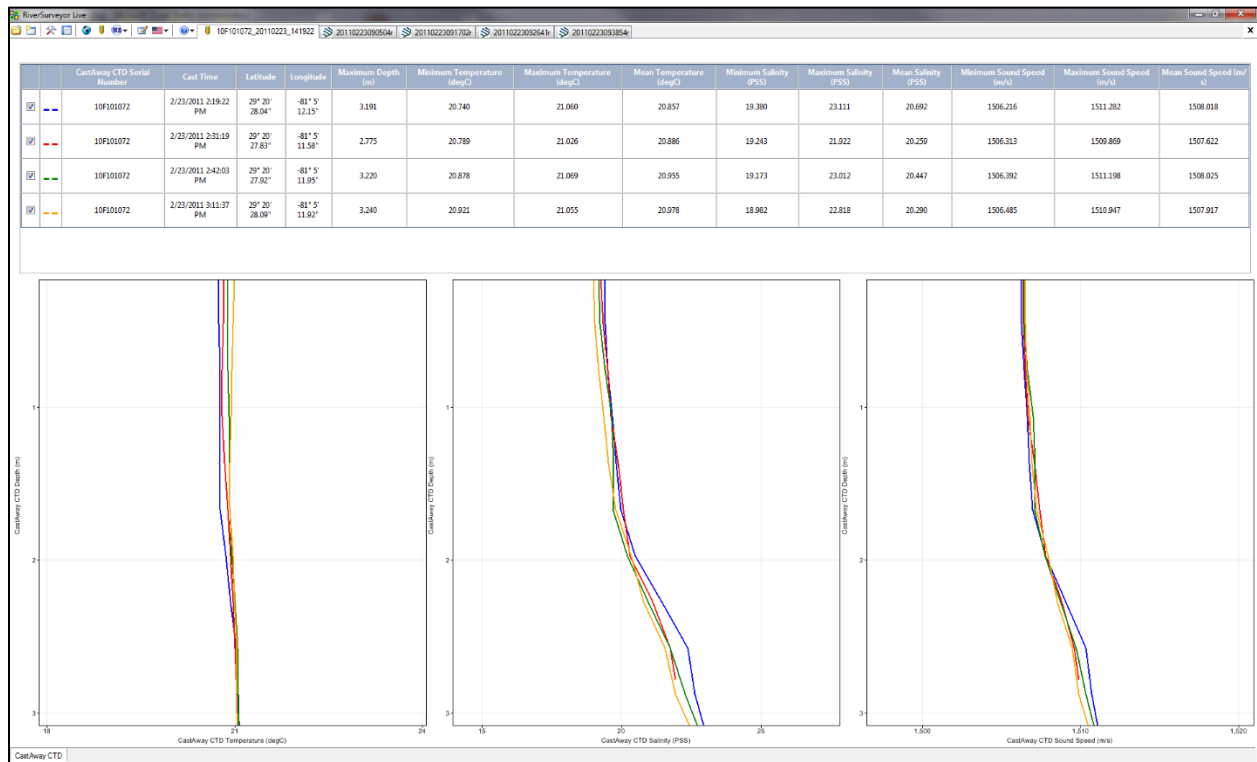

Figure 188. CastAway CTD Summary Information Tab.

The RiverSurveyor Live (v3.0 or later) software adds a marker for the CastAway profile location on the center ship track plot (Figure 189). The GPS coordinates must be changed to **UTM Display** by right-clicking on the track plot. Open the Processing Toolbox to select the *CastAway CTD Sound Speed Correction* from the drop-down box. There are two options for applying the CastAway sound speed correction to a discharge calculation: using ADP surface temperature data and CastAway surface salinity or using the full CastAway temperature and salinity profile. The correction can be done manually by selecting the appropriate .ctd file or automatically. If automatically, the software applies the .ctd file collected closest to the start of the discharge measurement. After applying the sound speed correction, you can instantly view the effect of the correction on the discharge calculation.

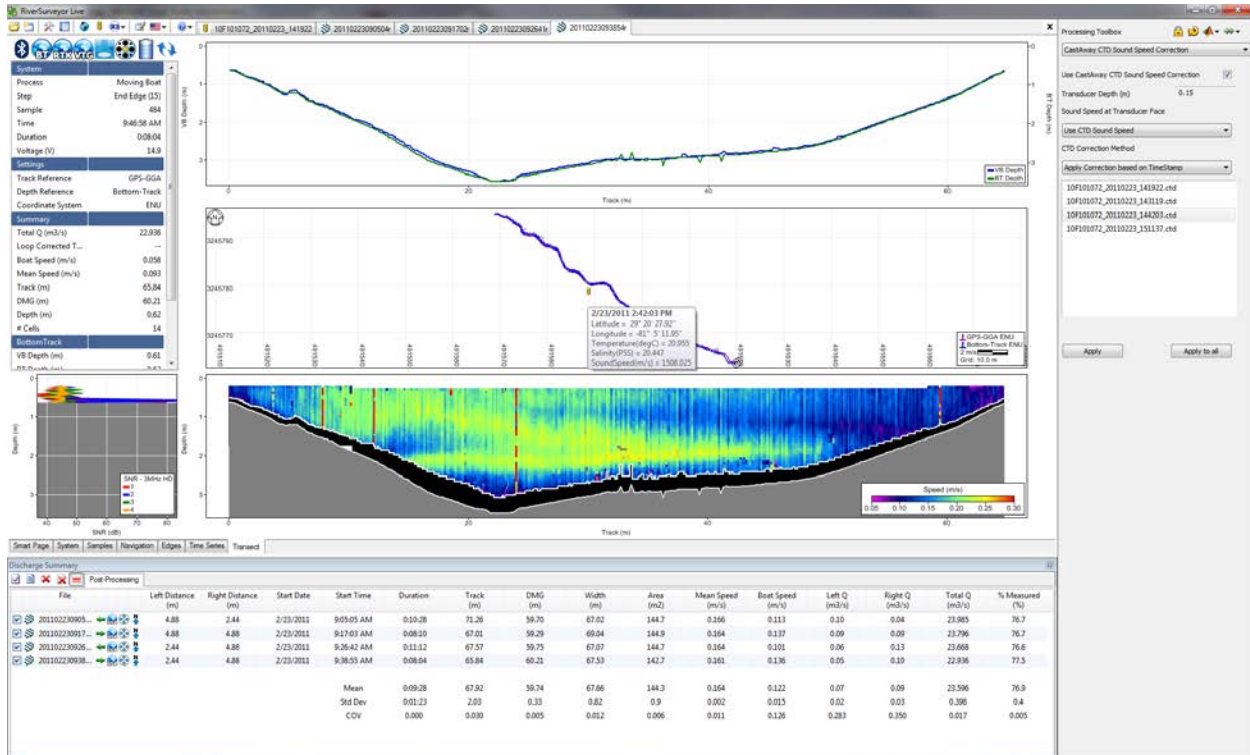

Figure 189. CastAway CTD Sound Speed Correction and UTM Track Location

Summary

Using CTD measurements to apply sound speed corrections to ADP data helps to further improve the measurement accuracy. ADP discharge measurements in rivers with large cross-sectional profiles and areas with high stratification such as estuaries will benefit the most from sound speed corrections. The fast response thermistor of the CastAway also ensures accurate temperature data required for all velocity measurements. The CastAway CTD and RiverSurveyor integration is a user-friendly way to apply sound speed corrections to ADP measurements and increase ADP measurement accuracy.

References

- SonTek, 2010, CastAway User’s Manual 1.3. [Available for download at <http://www.sontek.com>.]
- SonTek, 2011, RiverSurveyor S5/M9 System Manual. [Available for download at <http://www.sontek.com>.]
- SonTek, 2011, Technical Note: Phased Array and Velocity Measurements.
- SonTek, 2011, Technical Note: Range, velocity, Sound Speed and Snell’s Law.
- NOAA Office of Coast Survey, 2011, Field Procedures Manual. [Available online at http://www.nauticalcharts.noaa.gov/hsd/docs/Field_Procedures_Manual_May_2011.pdf]

Appendix J. Power and Communications Module II (PCM2)

J-1. What's new?

SonTek has developed a Second-Generation Power and Communications Module designed to replace the original, first generation PCM.

Several key features were changed and/or improved in this new release:



1. No external on/off button

- No more need to actually turn unit on/off. Unit will automatically power up upon battery insertion.
- PCM now has internal smart electronics that will put PCM in a low-power state when not connected to the RiverSurveyor M9/S5.
- PCM batteries will last for 7-10 days in this state, so you can prepare your system for deployment on Friday and by Monday morning only negligible voltage loss will have been observed, saving time and effort when preparing for field deployments in advance.

2. Battery options

- The PCM can use only the AA battery types specified in **Table 10** (up to 14.5 mm (0.570") in diameter).
- Each PCM has two battery compartments, each housing 8 AA batteries.
- The 8 batteries are housed in a cartridge that slides into the PCM, allowing for quick replacement in the field.
- The battery compartments run in parallel so the cartridges can be replaced one at a time to keep the PCM running during data collection. **However, it is recommended that both battery cartridges are loaded for optimal performance.**
- For customers requiring a rechargeable option, SonTek will continue to offer a rechargeable AA battery solution.

Table 10. Power Specifications

Hardware		Specification
Input Battery Voltage		8 – 12 VDC
Power Supply	Alkaline	8 x size AA/LR6 Alkaline Batteries
	NiMH	8 x size AA, Panasonic, Type BK200AAB, 1.2Vdc, 1900mAh
	The use of NiMH Rechargeable Batteries is only CE certified per IEC 62133 for PCM part number PCM-I-13 and higher.	
	Only this type of NiMH rechargeable batteries with IEC 62133 approvals can be used, or else safety protection will be void.	



Batteries should not be left in the PCM for prolonged periods as damage can occur if the batteries are leaking. It is recommended that batteries are removed when the instrument is not use.



Battery manufacturer guidelines must be followed during normal use, long term storage and charging requirements. The disposal of batteries must be done with care and it is recommended that local authority guidelines be used.

3. User pairing capability

- Do you operate more than one set of M9s with RTK and have been in the field with the Rover PCM from one system, but the Base PCM from another? Well, this is no longer a problem! All PCM rover-base pairing will be done by the user via the software as the PCMs are no longer permanently paired.

4. SonTek-developed multiplexing radio with optimized antenna positions capability and dual power mode

- Due to regional government-imposed limitations of the 900 MHz frequency, as well as outdoor transmit power limits for all 2.4 GHz radios, all PCMs now use a SonTek proprietary, multiplexing 2.4 GHz radio for all communications between PC, rover and base.
- The new PCMs do NOT have Bluetooth® capability!
- This new radio also allows for flexible antenna positioning, so that antennas can be raised or changed to improve range. SEE NOTE IN SECTION J-3 BELOW ABOUT RADIO RANGE PERFORMANCE.

5. External “Bridge” device for variable/future mobile support

- SonTek understands that mobile phone technology is advancing and at ever-increasing speed and both present and future platforms offer a wide array of features and capabilities.
- We are also aware of the limitations of standard Bluetooth® technology in terms of range and field usability, and as stated above, have opted not to include this technology in the new PCMs.
- To support future mobile developments and allow our customers the flexibility they are accustomed to, SonTek has created a “Bridge” device that will now be used to communicate between the mobile device and the PCM. This will also eventually allow for multiple platforms to be used.
- For this release, SonTek will continue to supply the Motorola Q Phone, but plans on phasing that out soon. With the new Bridge, different mobile systems will be able to be supported in the future—the mobile device communicates with the Bridge, and the Bridge communicates with the RiverSurveyor Power & Communications Module (PCM).
- The communication range between the mobile device and the Bridge is up to 10 m. The range between the Bridge and PCM is 200 m when using the supplied antenna (2 dBi) and the radio is set to the default transmit power (10 dBm).

6. Completely waterproof design (rated IP 67)

- This new design provides connectors and compartment covers that are fully waterproof to withstand the most demanding field conditions.
- The RiverSurveyor connector is fully recessed for added protection.

J-2. SonTek Communications Bridge

The Second Generation PCMs do NOT have Bluetooth® capability. This means that a separate device must be used to link the mobile device and the PCM. This device is the SonTek Communications Bridge, shown in the photos below. The Bridge allows for the support of existing and future mobile platforms by linking the communications from the mobile device to the Power & Communications Module (PCM), which use a proprietary SonTek-developed radio. The mobile device communicates to the Bridge (via Bluetooth) and the Bridge in turn communicates with the PCM.



Figure 190. SonTek Communications Bridge and mobile (far right) in supplied dry bag.

The SonTek Communications Bridge is powered by 2 AA batteries, which can be easily replaced by opening the Bridge. The communication range between the mobile device and the Bridge is up to 10 m, under ideal conditions. However, in order to avoid communications drop-outs we recommend keeping the bridge as close as possible to the mobile device. The range between the Bridge and PCM is 200 m when using the supplied antenna (2 dBi) and the radio is set to the default transmit power (10 dBm).

J-3. SonTek (USB) Radio

Due to regional government-imposed limitations of the 900 MHz frequency, as well as the transmit power of the 2.4 GHz frequency, all PCMs now use a SonTek-proprietary, multiplexing 2.4 GHz radio for all communications between PC, rover and base. This new radio also allows for flexible antenna positioning; so that antennas can be raised or changed to improve range, as well as two different transmit power modes for proper regional compliance.



Before changing antenna gain (default 2 dBi) or transmit power (default 10 dBm), it is YOUR responsibility to verify your regional communication regulations and certify you are abiding by them. SonTek is NOT responsible for user-supplied antennas and/or use of transmit power that violate government regulations. For example, most European countries, as well as Japan, are limited to 10 dBm (10 mW equivalent) for the 2.4 GHz frequency range.



Figure 191. SonTek USB Radio

The SonTek (USB) Radio has three options for transmit power:

- Low – 10 dBm (equivalent to 10 mW)
- Medium – 19 dBm (equivalent to ~80 mW)
- High – 22 dBm (equivalent to ~160 mW)

To change between these three options, simply select the desired transmit power in the System Settings section of the RiverSurveyor Live software SmartPage (see image below) or by using the Utilities software.

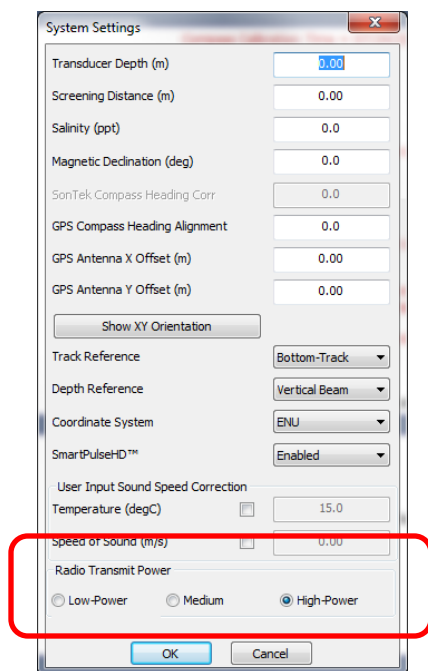

Figure 192. System Settings

SonTek supplies a 2 dBi gain antenna to be used with all PCMs. When used with the supplied antennas and the low-power setting (10 dBm), the ranges for the radios are:

- Base to Rover: 1000 m
- PC/Tablet to Rover (via USB radio): 450 m
- Mobile to Rover (via Bridge): 200 m

When used with the supplied antennas and the high-power setting (22 dBm), the ranges for the radios are:

- Base to Rover: 3000 m
- PC/Tablet to Rover (via USB radio): 1500 m
- Mobile to Rover (via Bridge): 400 m

IMPORTANT NOTE ABOUT RADIO RANGE PERFORMANCE:

- SonTek has fully tested its radios and guarantees the above ranges for *line-of-sight* conditions.
- Field conditions are variable and radio ranges can be affected by a number of environmental factors, transmit power and antenna gain.
- Water can act as a strong absorber of radio frequencies in the 2.4 GHz range. As such, significantly improved radio performance can be achieved by raising antennas above the water surface as much as possible. SonTek provides external antennas as well as extension cables (for the DGPS and RTK configurations) for this purpose.
- Surface water conditions have significant impact on ranges. The calmer the water surface, the greater the range.
- Salt water can also influence range as it absorbs more energy in the 2.4 GHz frequency range than freshwater does.

One of the new features that the RiverSurveyor Live and RiverSurveyor Stationary Live software provide is the Received Signal Strength Indicator (RSSI), which is a measure of how strong the signal is. Two values are given (see figure below): one for the link between the PC and Rover (“RSSI Rover”) and the other is the link between Base Station and Rover (“RSSI Base”)—this second one is only applicable to RTK systems.

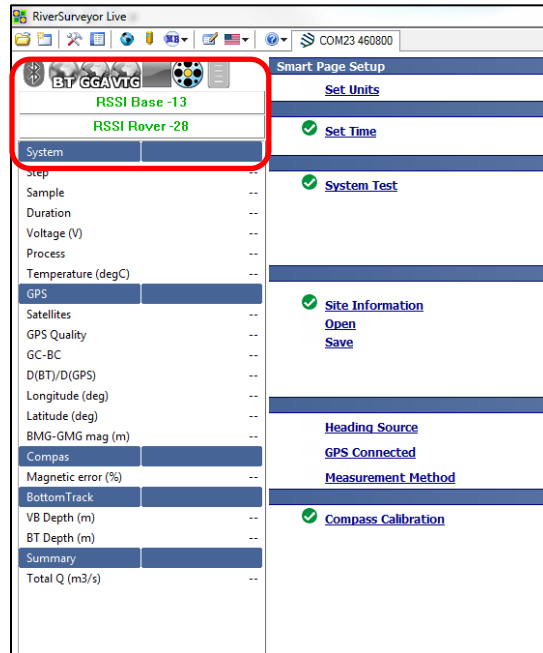

Figure 193. RiverSurveyor Live RSSI Values

Working ranges for RSSI may vary as a function of the amount of data being transmitted. However, the typical (approximate) RSSI ranges for the RiverSurveyor system is between -20 dBm (maximum) to -85 dBm (minimum). Chances of dropping communications increase as the RSSI decreases.

J-4. Configuration A – PCM (Telemetry Only)

This is the basic PCM configuration. It offers telemetry (via the SonTek 2.4 GHz radio) and power to the RiverSurveyor system. This Second Generation PCM replaces both the original Bluetooth and Spread Spectrum telemetry only PCMs.

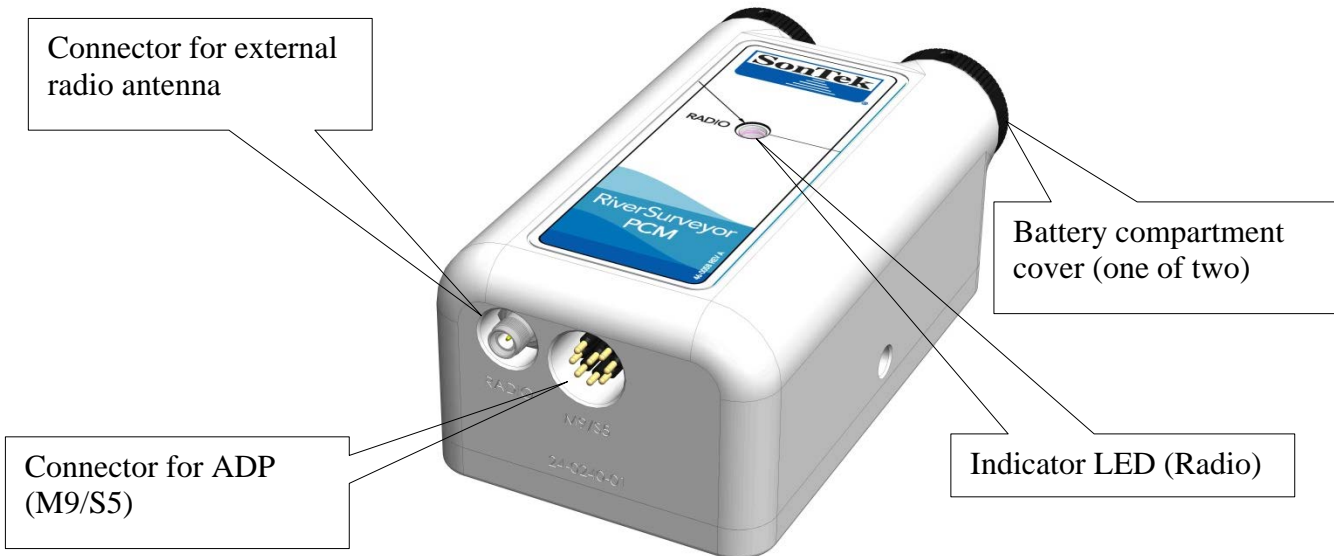

Figure 194. Configuration A – PCM (Telemetry Only)

As shown in the above image, this configuration contains one recessed 8-pin wet-mateable plug to connect to the RiverSurveyor M9/S5. It also contains one TNC connector for the external radio telemetry antenna.



Figure 195. Configuration A – PCM (Telemetry Only). Figure shows the different methods of connecting to the PCM: Via mobile phone (through Bridge), or through PC (via radio dongle on the left of the image).

J-4.1 Hardware Setup

Please use the following directions for PCM setup:

1. Mount the ADP system on the boat, HydroBoard or another floating platform
2. Connect the PCM to the ADP using the supplied black cable (typically 1 or 10 m)
3. Load both battery cartridges with 8 AA batteries each and slide them into the PCM battery compartments.
4. Connect the SonTek Radio Dongle to the PC or connect via the mobile phone through Bridge. If connecting through the Bridge, turn on the bridge and wait until magenta light stops blinking. Then select CONNECT on the phone.
5. Follow the directions outlined in **Section 5** to make a discharge measurement

J-5. Configuration B – Differential GPS (DGPS)

This configuration offers telemetry (via a proprietary 2.4 GHz radio) and power to the RiverSurveyor system. It also offers a Differential GPS solution (DGPS) for vessel movement computation. This Second Generation PCM replaces both the original Bluetooth and Spread Spectrum DGPS PCMs.



Figure 196. Configuration B – PCM DGPS. Figure shows the PCM and its main components.

As shown in the above image, this configuration contains one recessed 8-pin wet-mateable plug to connect to the RiverSurveyor M9/S5. It also contains two TNC connectors: one for the external radio telemetry antenna and another for the GPS antenna. For improved radio range, note the external antenna should be raised by using the extension cable provided with the system.



Figure 197. Configuration B – PCM DGPS. Figure shows the different methods of connecting to the PCM: Via mobile phone (through Bridge), or through PC (via radio dongle on the left of the image). Figure also shows the GPS antenna with accompanying radio antenna and extension cord.

J-5.1 Hardware Setup

Please use the following directions for PCM setup:

1. Mount the ADP system on the boat, HydroBoard or another floating platform
2. Connect the PCM to the ADP using the supplied black cable (typically 1 or 10 m)
3. Load both battery cartridges with 8 AA batteries each and slide them into the PCM battery compartments.
4. Connect the SonTek Radio Dongle to the PC or connect via the mobile phone through Bridge. If connecting through the Bridge, turn on the bridge and wait until magenta light stops blinking. Then select CONNECT on the phone.
5. Install the GPS antenna on vessel to be used and connect it to the PCM. Make sure antenna has a clear view of the sky.
6. Connect the GPS cable to the GPS cable connector on the PCM and the GPS antenna.
7. Install the external radio antenna as high as possible on the vessel. Antenna height is a critical condition for maximum radio range. The higher the antenna, the longer the range.
8. Follow the directions outlined in **Section 5** to make a discharge measurement

J-6. Configuration C – Real-Time Kinematic GPS (RTK-GPS)

This configuration offers telemetry (via a proprietary 2.4 GHz radio) and power to the RiverSurveyor system. It also offers a Real-time Kinematic GPS solution (RTK-GPS) for vessel movement computation. This Second Generation PCM replaces both the original Bluetooth and Spread Spectrum RTK-GPS PCMs.

The SonTek RTK Solution utilizes both a moving GPS antenna (Rover) as well as a stationary GPS antenna (Base). The Base Station sends corrections to the Rover and this allows it to obtain RTK position quality.



Figure 198. Configuration C – PCM RTK-GPS (Rover). The Figure shows the Rover PCM and its components. Note this is the *same* PCM as used for DGPS.

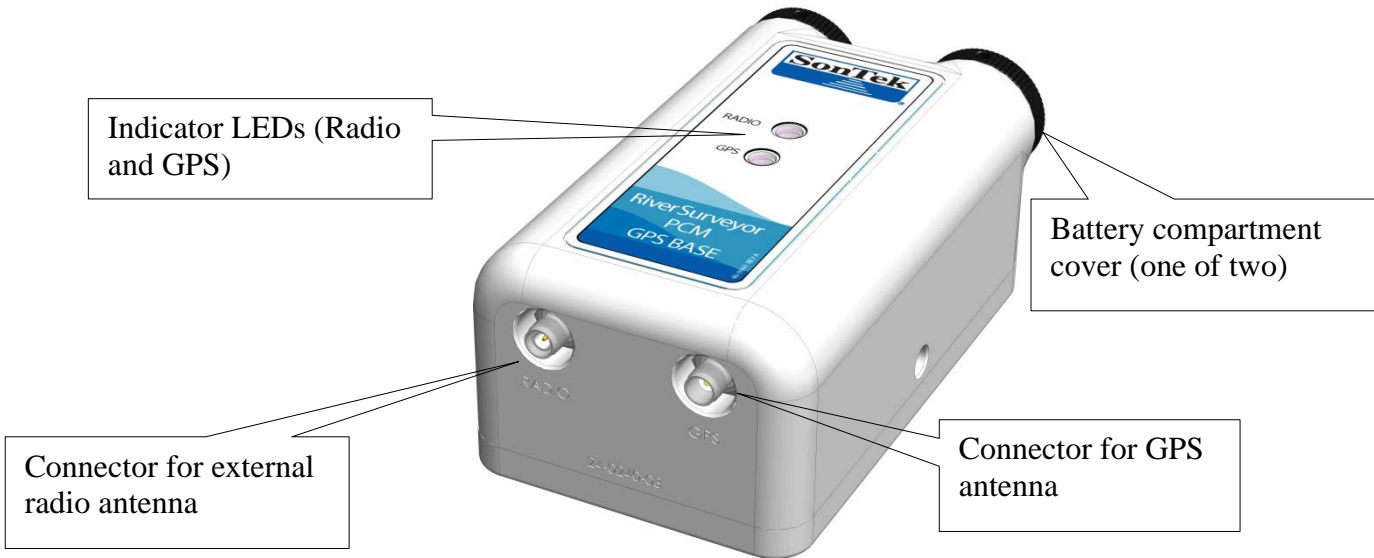

Figure 199. Configuration C – PCM RTK-GPS (Base). The Figure shows the RTK Base Stations and its components.

As shown in the above image, this configuration two TNC connectors: one for the external radio telemetry antenna and another for the GPS antenna. For improved radio range, note the external antenna should be raised by using the extension cable provided with the system.



Figure 200. Configuration C – PCM RTK-GPS. Figure shows the different methods of connecting to the PCM: Via mobile phone (through Bridge (not pictured)), or through PC (via radio dongle on the left of the image). Figure also shows the GPS antenna with accompanying radio antenna and extension cord as well as the base station (typically mounted on a tripod as in the following figure).



Figure 201. Base Station for Configuration C – PCM RTK-GPS. Figure shows a typical setup with GPS antenna on center of tripod and PCM attached to one of the tripod’s legs via the provided adaptor bracket. Note PCM can be placed on ground as well.



NOTE: Users operating both HydroSurveyor AND RiverSurveyor applications and using absolute RTK positioning with the SonTek RTK system under HydroSurveyor, you must disable the absolute RTK positioning in HydroSurveyor (by selecting “Not Applicable” in the HydroSurveyor Settings *before* connecting to the RiverSurveyor applications; otherwise, the software will not find the GPS system.

J-6.1 Pairing PCM Base with PCM Rover



ATTENTION! The Second Generation PCMs (Base & Rover shipped after July 2013) do NOT come paired from the factory like the original PCMs. They must be paired prior to being used for the first time!

A Second Generation PCM Base Station can be paired with any Second Generation PCM Rover. Please follow these instructions in order to pair the PCM Rover with the PCM Base Station. This procedure only must be done once prior to first use. PCMs can, however, be re-paired with other PCMs should you decide, but only ONE active pair can exist at the same time.

1. Make sure each PCM is powered and within proximity (less than 10 m) of the PC. This procedure cannot be done with the mobile software.

2. Plug the SonTek USB radio to the PC and wait about 20 s until the light on the USB Radio begins to blink blue.
3. Launch the Utilities software
4. On the Utilities software, click the “Pair” button under “Advanced Functions”. A “Select a System” window will appear (see below).

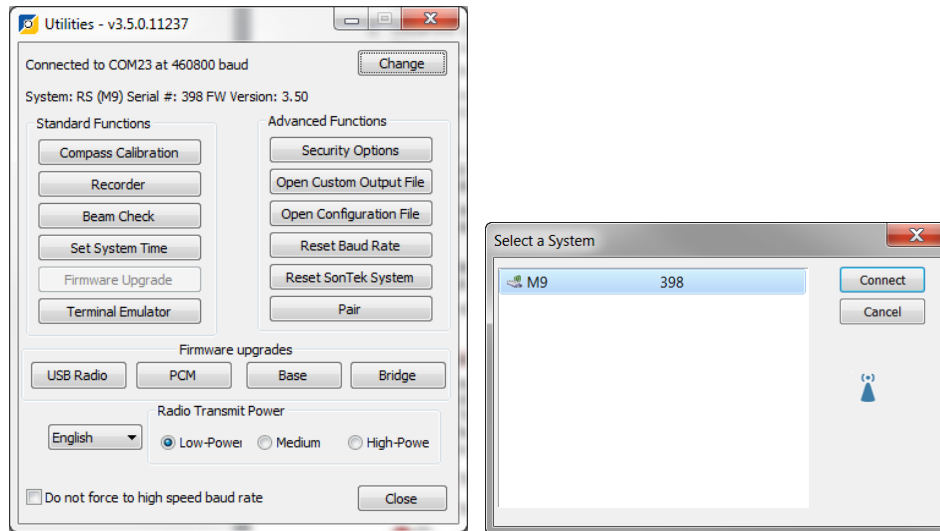

Figure 202. Pairing Base and Rover.

5. Follow the on-screen directions and then immediately click “Close”.
6. Once pairing is successful, you will get the below dialog box. Click “Close” and pairing is complete.

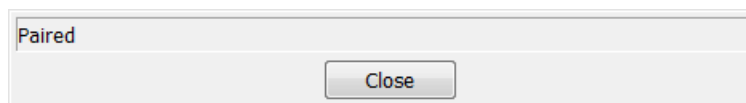

Figure 203. Pairing Base and Rover – Successful Pairing Completed.

J-6.2 Hardware Setup

Please use the following directions for PCM setup:

1. Mount the ADP system on the boat, HydroBoard or another floating platform
2. Connect the PCM to the ADP using the supplied black cable (typically 1 or 10 m)
3. Load all four battery cartridges with 8 AA batteries each and slide them into the PCM and RTK Base battery compartments.
4. Connect the SonTek Radio Dongle to the PC or connect via the mobile phone through Bridge. If connecting through the Bridge, turn on the bridge and wait until magenta light stops blinking. Then select CONNECT on the phone.
5. Install the GPS antenna on vessel to be used and connect it to the PCM. Make sure antenna has a clear view of the sky.
6. Connect the GPS cable to the PCM and the GPS antenna.

7. Install the external radio antenna as high as possible on the vessel. Antenna height is a critical condition for maximum radio range. The higher the antenna, the longer the range.
8. Install the tripod near the measurement location and make sure antenna has a clear view of the sky. For optimal performance, make sure the base station is mounted as high as possible near the measurement site.
9. Install the external radio antenna as high as possible on the tripod. Antenna height is a critical condition for maximum radio range. The higher the antenna, the longer the range.
10. Follow the directions outlined in **Section 5** to make a discharge measurement.

J-7. Optional Tablet

The optional tablet comes with:

1. Dell Venue 8 Pro 32 GB
2. Right-Angle MicroUSB OTG adapter
3. Waterproof bag

Optional Accessories

1. Dell SafePort Rugged Max Pro case
2. Hand strap and shoulder strap for the case

1.

J-7.1 Hardware Setup

Please use the following directions for tablet setup:

1. Mount the ADP system on the boat, HydroBoard or another floating platform
2. Connect the PCM to the ADP using the supplied black cable (typically 1 or 10 m)
3. Load the battery cartridges with 8 AA batteries each and slide them into the PCM (and RTK Base if present) battery compartments.
4. Connect the SonTek Radio Dongle and antenna to the supplied MicroUSB to USB adapter as shown below.



Figure 204. Connecting MicroUSB to USB adapter to SonTek Radio Dongle

5. Two 3M Dual Lock adhesive fasteners are provided to secure the adapter and dongle to the back of either the tablet or the optional ruggedized case.









Figure 205. Securing the adapter and USB dongle to the tablet

6. Once the USB dongle is connected and the red LED light stops blinking, it is ready to connect.
7. Follow the directions outlined in **Section 5** to make a discharge measurement

J-8. LED Description

All three communications components available with the RiverSurveyor system—SonTek Radio Dongle, PCMs and Bridge—have multi-colored LEDs that indicate the system's working conditions and status. The following table describes the light pattern for the LEDs on these components. Because the lights are multi-color and can have solid as well as blinking status, the following convention is used:

-   -- This indicates a solid blue light
-   -- This indicates a light alternating between yellow and green
-   -- This indicates a blinking red light (gray = off)

	USB Radio	PCM Radio	PCM GPS	Base Radio	Base GPS	Bridge
Initial system power up (may take up to 20 s for radio to light up). Condition lasts about 10-20 s only.			N/A		N/A	
Radio on Stand-by. PCM can stay in this state for about 10 days; PC cannot connect to PCM; GPS is powered off. NOTE: light blinking rate is slow (~2s).	Slow 	Slow 	N/A	Slow 	N/A	Slow
Attempting Communication. Radio is trying to connect to a device. NOTE: light blinking rate is fast (~0.5s).			N/A		N/A	
Available for Connection. PCM is ready to connect to PC; GPS is powered on.			N/A		N/A	N/A
Connected. Communication successfully established between radio and PCM and/or Base Station and/or Bridge and phone			N/A		N/A	
Waiting for Pairing Connection	N/A		N/A		N/A	N/A
GPS actively searching for satellites but not yet locked on any.	N/A	N/A		N/A		N/A
Basic GPS lock for RTK only For RTK systems = GPS Quality 1 With base on and connected	N/A	N/A		N/A	N/A	N/A
Basic GPS lock for RTK only For RTK system = GPS Quality 1 With base off or disconnected	N/A	N/A		N/A	N/A	N/A
Acquired improved GPS lock. For RTK systems = GPS Quality 5 or 2 For DGPS systems = GPS Quality 1	N/A	N/A		N/A		N/A
Optimal lock quality. For RTK systems = GPS Quality 4 For DGPS systems = GPS Quality 2	N/A	N/A		N/A		N/A
Error. Communications and/or electronics error. Contact SonTek Technical Support						

Appendix K. Compass Calibration for G0-G2 Compasses



TO ENSURE DATA QUALITY WHEN REFERENCING A MEASUREMENT TO GPS, PLEASE READ CAREFULLY THE INSTRUCTIONS CONTAINED IN THIS SECTION

When making a discharge measurement using the RiverSurveyor S5 or M9 system, the system's internal compass (or an external heading sensor, such as a GPS Compass – see Appendix E) is used to provide the instrument's heading as it moves across the channel. Unlike GPS Compasses, the M9/S5 internal (magnetic) compass must be calibrated prior to data collection.

A proper user-performed compass calibration at the field measurement site prior to collecting data is a critical step for avoiding heading errors during the measurement, as the compass calibration is used to compensate for localized magnetic interference in the vicinity of the instrument. If heading errors are observed during the measurement, then a review should be performed of the methodology used for the compass calibration, and of the local surroundings where the calibration was performed for potential sources of magnetic interference, in order to locate the cause(s) of the heading errors.

A primary consideration is that the internal (magnetic) compass calibration is designed to be representative of the conditions that will be experienced during the actual measurement. When calibrating the compass, the RiverSurveyor S5/M9 should be rotated through two complete circles while varying the pitch and roll smoothly through the greatest tilt angles possible and practical. **The keys to a proper compass calibration are slow rotations in a relatively low magnetic field, using pitch and roll angles similar to what will be experienced on the boat or floating platform during the actual data collection.** For example, if the measurement will be performed at a site with flat surface water conditions, then a compass calibration using smaller pitch and roll angles may be enough (but NOT totally flat). However, if the boat or floating platform will be experiencing large pitch and roll angles during the measurement, then the calibration needs to be performed using large pitch and roll angles during the rotations. If smaller pitch and roll angles are used during the compass calibration procedure than what will be experienced during the actual measurement, there will be the potential for significant heading errors. Conversely, calibrating the compass using significantly large pitch and roll angles and then making the actual measurement where very small pitch and roll angles will be experienced could also lead to heading errors.

In addition, the pitch and roll angles applied during the calibration should be done at a relatively slow rate (such as what one might use when operating/panning a video camera). Varying the pitch and roll angles too quickly or erratically will cause the RiverSurveyor S5/M9's internal accelerometers to report unrealistic heading values for a given calibration point, resulting in significant calibration errors.

It is also important that the compass calibration be performed in the same environment as where the actual measurement will be performed. For example, it is not adequate to

perform a calibration in a parking lot far from the water's edge, or on a concrete bridge deck far above the water surface, etc. In addition, prior to the calibration it is important to look around to ensure that there are not any sources of magnetic interference in the area where the compass calibration will be performed. Potential sources of interference include large ferrous metal objects, metal hulled vessels, concrete structures with rebar, power transmission lines, automobiles, etc.

Specific calibration instructions follow:

1. Prior to the calibration, all magnetic material or sources of interference should be removed from the immediate vicinity, such as cell phones/mobile electronic devices, wristwatches, keys, hand tools, etc.
2. If the RiverSurveyor will be mounted on a floating platform, the compass calibration must be performed with the system installed on the platform along with the other components. If the RiverSurveyor will be used from a manned boat, the compass calibration must be performed using the entire boat with the RiverSurveyor mounted in the exact place and orientation in which it will be used during the actual measurement. Everything that will be physically attached to the RiverSurveyor system during the actual measurement must be treated as part of the system and therefore rotated along with the S5/M9.
3. The RiverSurveyor S5/M9 and boat/floating platform should be rotated through two complete circles, taking 60 seconds for each rotation. The RiverSurveyor Live software will limit the calibration routine to a maximum of 120 seconds, so the operator should try to perform one rotation per minute.
4. The pitch and roll angles should be varied during the rotations. For the best calibration results, the angles used should be similar to what will be experienced during the measurement transects. When making a measurement, it is important to keep in mind that the calibration will only be valid over the same pitch and roll angles experienced during the compass calibration procedure. **It is critical that the variation in pitch and roll be done SLOWLY. The internal compass uses accelerometers (similar to those used in modern video-game consoles) and as such can generate erroneous tilt angles should the system's tilt be varied too fast during the calibration routine. A typical rate is about 2-3 seconds to go from one tilt limit (e.g. high positive roll) to another (e.g. high negative roll).**
5. After the calibration, there must not be any changes made to the position of engines or mounts, or any other metal components on the boat, such as toolboxes, electronic devices, etc. If any position changes are made, the compass calibration should be repeated so that the system can account for the new, current, magnetic field affects.

To calibrate the compass, click on "Compass Calibration" on the Smart Page tab. The following window will appear. Click the Compass Calibration link and click Start in the pop-up window or Open to load an existing calibration file.

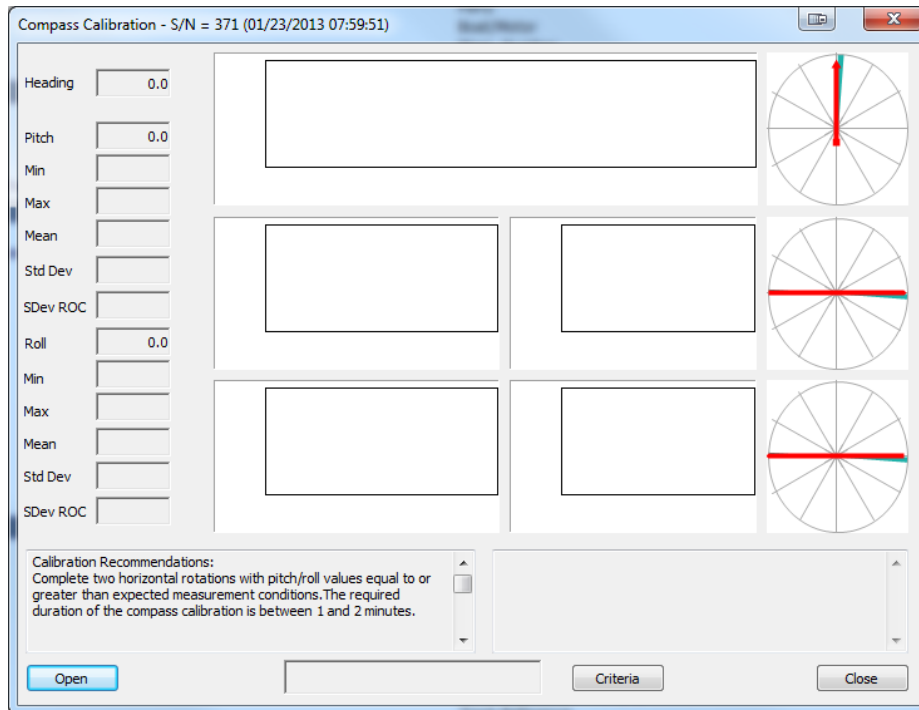

Figure 206. Compass Calibration window. Depending on the version of the compass firmware in your system, you may also be asked to input the max pitch and roll angles expected during the measurement.

Click **Stop** upon completion of the compass calibration procedure. The calibration results and feedback are displayed in the window below.

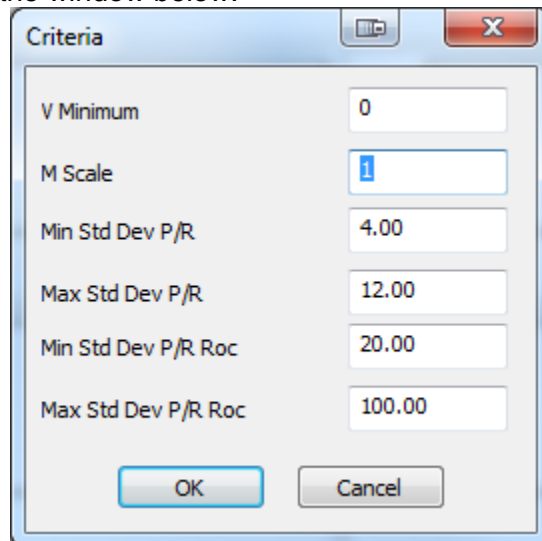

Figure 207. Compass Calibration Results

Compass Calibration feedback:

1. Clean Cal (Q9 H9 V9 M5):

Passed Calibration

Calibration duration = 110 seconds

M5.00 = Magnetic influence is acceptable

Q9 = Magnetic field is uniform

H9 = Complete horizontal rotation

V9 = High pitch/roll

Recommendation(s):

Avoid any changes to the instrument setup or its orientation to the magnetic influences detected during the compass calibration.

Measurements should be made in locations with similar magnetic influences as the location of the compass calibration.

2. Clean Cal with low pitch/roll (Q9 H9 V3 M10):

Passed Calibration

Calibration duration = 110 seconds

M10.00 = Magnetic influence is acceptable

Q9 = Magnetic field is uniform

H9 = Complete horizontal rotation

V3 = Low pitch/roll

Recommendation(s):

Measurements should be made with low pitch/roll OR repeat calibration with more pitch/roll.

Avoid any changes to the instrument setup or its orientation to the magnetic influences detected during the compass calibration.

Measurements should be made in locations with similar magnetic influences as the location of the compass calibration.

3. Magnetic influence (Q0 H9 V9 M211):

Failed Calibration. Please Repeat Calibration!

Calibration duration = 110 seconds

M211.00 = Magnetic influence is unacceptable

Q0 = Non-uniform magnetic field

H9 = Complete horizontal rotation

V9 = High pitch/roll

Recommendation(s):

Magnetic influence needs to be reduced in order to calibrate compass.

a. Consider calibrating compass in another physical location away from any large ferrous objects above/below the water surface (i.e. reinforced concrete piers or bridges, large metal boats/buildings, pipelines, large ships, etc...). Measurements should be made in locations with similar magnetic influences as the location of the compass calibration.

b. Check area in vicinity of instrument for smaller ferrous objects (i.e. hand tools, hardware, cell phones, keys, etc...) and remove those objects or increase the distance between the small ferrous objects and instrument

4. Magnetic influence with low pitch/roll (Q4 H9 V2 M157):

Failed Calibration. Please Repeat Calibration!

Calibration duration = 110 seconds

M157.00 = Magnetic influence is unacceptable

Q4 = Non-uniform magnetic field

H9 = Complete horizontal rotation

V2 = Low pitch/roll

Recommendation(s):

Magnetic influence needs to be reduced in order to calibrate compass.

- a. Consider calibrating compass in another physical location away from any large ferrous objects above/below the water surface (i.e. reinforced concrete piers or bridges, large metal boats/buildings, pipelines, large ships, etc...). Measurements should be made in locations with similar magnetic influences as the location of the compass calibration.
- b. Check area in vicinity of instrument for smaller ferrous objects (i.e. hand tools, hardware, cell phones, keys, etc...) and remove those objects or increase the distance between the small ferrous objects and instrument

5. Clean Cal (Q9 H9 V7 M21):

Passed Calibration

Calibration duration = 110 seconds

M21.00 = Magnetic influence is acceptable

Q9 = Magnetic field is uniform

H9 = Complete horizontal rotation

V7 = High pitch/roll

Recommendation(s):

Avoid any changes to the instrument setup or its orientation to the magnetic influences detected during the compass calibration.

Measurements should be made in locations with similar magnetic influences as the location of the compass calibration.

6. 1/3rd horizontal rotation (Q9 H4 V6 M10):

Failed Calibration. Please Repeat Calibration!

Calibration duration = 110 seconds

M10.00 = Magnetic influence is acceptable

Q9 = Magnetic field is uniform

H4 = Incomplete horizontal rotation

V6 = High pitch/roll

Recommendation(s):

Repeat calibration with two complete horizontal rotations. The required duration of the compass calibration is between 1 and 2 minutes.

7. **On the bridge with no pitch/roll (Q8 H9 V3 M46):**

Passed Calibration

Calibration duration = 110 seconds

M46.00 = Magnetic influence is acceptable

Q8 = Magnetic field is uniform

H9 = Complete horizontal rotation

V3 = Low pitch/roll

Recommendation(s):

Measurements should be made with low pitch/roll OR repeat calibration with more pitch/roll.

Avoid any changes to the instrument setup or its orientation to the magnetic influences detected during the compass calibration.

Measurements should be made in locations with similar magnetic influences as the location of the compass calibration.

8. **Less than 1 minute calibration (Q9 H9 V9 M5):**

Failed Calibration. Please Repeat Calibration!

Calibration duration = 45 seconds

M5.00 = Magnetic influence is acceptable

Q9 = Magnetic field is uniform

H9 = Complete horizontal rotation

V9 = High pitch/roll

Recommendation(s):

The required duration of the compass calibration is between 1 and 2 minutes.